

# **DL9040/DL9140/DL9240 Series Digital Oscilloscope**

# **U S E R ' S M A N U A L**

---

# Product Registration

Thank you for purchasing YOKOGAWA products.

YOKOGAWA provides registered users with a variety of information and services.

Please allow us to serve you best by completing the product registration form accessible from our homepage.

**<http://www.yokogawa.com/tm/>**

---

## Foreword

Thank you for purchasing the DL9040/DL9140/DL9240 Series Digital Oscilloscope (DL9040/DL9040L/DL9140/DL9140L/DL9240/DL9240L, hereafter referred to as the DL9000). This user's manual contains useful information about the functions, operating procedures, and handling precautions of the DL9000. To ensure correct use, please read this manual thoroughly before beginning operation. After reading the manual, keep it in a convenient location for quick reference whenever a question arises during operation. The following two manuals, including this one, are provided as manuals for the DL9000. Read them along with this manual.

Manual Title	Manual No.	Description
DL9040/DL9140/DL9240 Series Digital Oscilloscope User's Manual	IM 701310-01E	This manual. Explains all functions and procedures of the DL9040/DL9140/DL9240 Series excluding the communication functions.
DL9040/DL9140/DL9240 Series Digital Oscilloscope Communication Interface User's Manual (in CD)	IM 701310-17E	Explains the communication interface functions of the DL9040/DL9140/DL9240 Series.
DL9040/DL9140/DL9240 Series Digital Oscilloscope Serial Bus Signal Analysis Function User's Manual	IM 701310-51E	Explains the operating procedures of the optional I <sup>2</sup> C bus signal/CAN bus signal/LIN bus signal/SPI bus signal analysis function.
DL9000 Series Digital Oscilloscope Power Supply Analysis Function User's Manual	IM 701310-61E	Explains the operating procedures of the optional power supply analysis function.

## Notes

- The contents of this manual are subject to change without prior notice as a result of continuing improvements to the instrument's performance and functions. The figures given in this manual may differ from the actual screen.
- Every effort has been made in the preparation of this manual to ensure the accuracy of its contents. However, should you have any questions or find any errors, please contact your nearest YOKOGAWA dealer.
- Copying or reproducing all or any part of the contents of this manual without the permission of Yokogawa Electric Corporation is strictly prohibited.

## Trademarks

- Microsoft, Internet Explorer, MS-DOS, Windows, Windows NT, Windows 2000, Windows Me, and Windows XP are either registered trademarks or trademarks of Microsoft Corporation in the United States and/or other countries.
- Adobe, Acrobat, and PostScript are trademarks of Adobe Systems Incorporated.
- For purposes of this manual, the TM and © symbols do not accompany their respective trademark names or registered trademark names.
- Other company and product names are trademarks or registered trademarks of their respective companies.

## Revisions

- 1st Edition: June 2005
- 2nd Edition: August 2005
- 3rd Edition: January 2006
- 4th Edition: June 2006
- 5th Edition: December 2006
- 6th Edition: August 2007

# Checking the Contents of the Package

Unpack the box and check the contents before operating the instrument. If some of the contents are not correct or missing or if there is physical damage, contact the dealer from whom you purchased them.

## DL9000

Check that the product that you received is what you ordered. The table below contains information about the available models, suffix codes, and options for your reference.

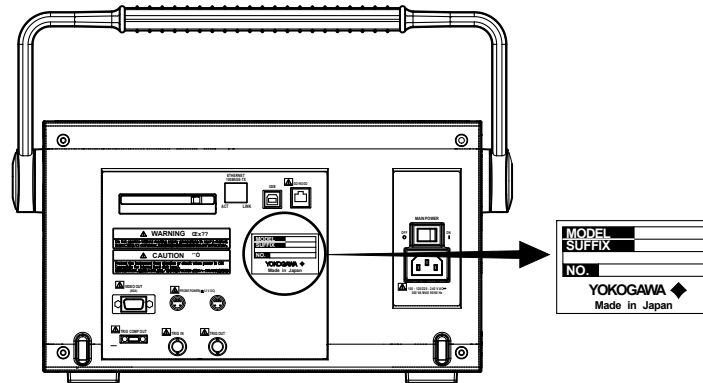

MODEL	SUFFIX	Specifications
701307		DL9040 Digital Oscilloscope 4 channels, 5 GS/s 500 MHz, max. 2.5 MW/channel
701308		DL9040L Digital Oscilloscope 4 channels, 5 GS/s 500 MHz, max. 6.25 MW/channel
701310		DL9140 Digital Oscilloscope 4 channels, 5 GS/s 1 GHz, max. 2.5 MW/channel
701311		DL9140L Digital Oscilloscope 4 channels, 5 GS/s 1 GHz, max. 6.25 MW/channel
701312		DL9240 Digital Oscilloscope 4 channels, 10 GS/s 1.5 GHz, max. 2.5 MW/channel
701313		DL9240L Digital Oscilloscope 4 channels, 10 GS/s 1.5 GHz, max. 6.25 MW/channel
Power cord	-D	UL/CSA Standard power cord (Part No.: A1006WD) [Maximum rated voltage: 125 V]
	-F	VDE Standard Power Cord (Part No.: A1009WD) [Maximum rated voltage: 250 V]
	-Q	BS Standard Power Cord (Part No.: A1054WD) [Maximum rated voltage: 250 V]
	-R	AS Standard Power Cord (Part No.: A1024WD) [Maximum rated voltage: 250 V]
	-H	GB Standard Power Cord (Part No.: A1064WD) [Maximum rated voltage: 250 V]
Help language	-HJ	Japanese
	-HE	English
	-HC	Chinese
	-HK	Korea
Options	/B5	Built-in printer
	/P2	Probe power supply
	/C8 <sup>1</sup>	Built-in hard disk drive and Ethernet interface
	/C10 <sup>1</sup>	Ethernet interface
	/G2 <sup>2</sup>	User define math function
	/G4 <sup>2</sup>	Power supply analysis function
	/F5 <sup>3</sup>	I <sup>2</sup> C + SPI bus analysis function
	/F7 <sup>3</sup>	CAN + LIN + SPI bus analysis function
/F8 <sup>3</sup>	I <sup>2</sup> C + CAN + LIN + SPI bus analysis function	

1 /C8 and /C10 options cannot be specified simultaneously.

2 /G2 and /G4 options cannot be specified simultaneously. /G4 includes /G2.

3 /F5, /F7, and /F8 options cannot be specified simultaneously.

- **No. (Instrument No.)**

When contacting the dealer from which you purchased the instrument, please give them the instrument number.

## Standard Accessories

The standard accessories below are supplied with the instrument. Check that all contents are present and that they are undamaged.

**Power Cord (one of the following power cords is supplied according to the instrument's suffix codes)**

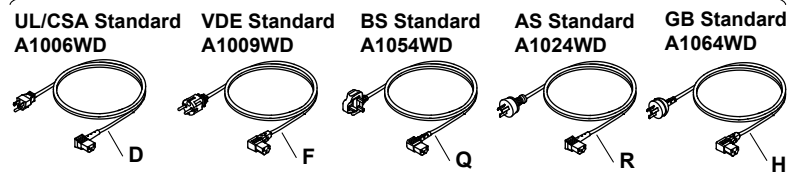

**Printer roll paper\*1**  
B9988AE 3 rolls

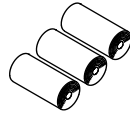

**Rubber Feet**  
B8080FR  
6 pcs

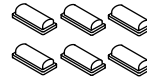

**Front panel protection cover**  
B8080EM

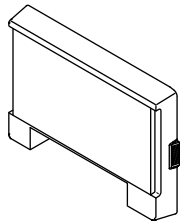

**500 MHz Passive Probe PB500**  
701943 4 probes

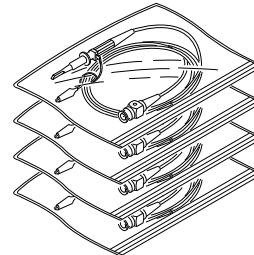

**A set of manuals**

- This manual
- User's manual for the serial bus signal analysis function or power supply analysis function (1 each)\*2
- Other manuals

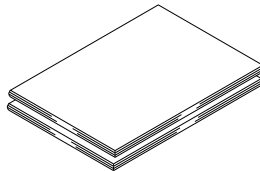

**Soft case**  
B8080FQ

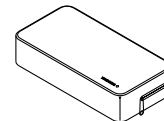

**Communication interface**  
User's manual\*3  
B8080RE(CD)

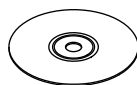

\*1 When using the optional built-in printer (/B5)

\*2 Included with the /F5, /F7, or /F8 option or /G4 option.

\*3 Printed manual IM701310-17E can be purchased separately. Contact your nearest YOKOGAWA dealer.

## Checking the Contents of the Package

---

### Optional Accessories (Sold Separately)

The optional accessories below are available for purchase separately. For information and ordering, contact your nearest YOKOGAWA dealer.

Name	Model	Specifications
PB500 (10 : 1 passive probe)	701943	10 M $\Omega$ (10 : 1), 500 MHz, 1.5 m (one piece in one set)
PBA2500 (2.5 GHz active probe)	701913	2.5 GHz bandwidth, for the DL9000 Series
PBD2000 (2 GHz differential probe)	701923	2 GHz bandwidth, for the DL9000 Series
PBL5000 (5 GHz probe)	701974	5 GHz bandwidth, with an SMA-BNC adapter
DC block	701975	For 50 ohm input, SMA
FET probe	700939	900 MHz bandwidth
100 : 1 probe	700978	100 MHz bandwidth
Differential probe	700924	DC to 100 MHz bandwidth/max. $\pm$ 1400 V
Differential probe	700925	DC to 15 MHz bandwidth/max. $\pm$ 500 V
Differential probe	701920	DC to 500 MHz bandwidth/max. $\pm$ 30 V
Differential probe	701921	DC to 100 MHz bandwidth/max. $\pm$ 700 V
Differential probe	701922	DC to 200 MHz bandwidth/max. $\pm$ 20 V
Current probe	701932	DC to 100 MHz bandwidth, 30 Arms
Current probe	701933	DC to 50 MHz bandwidth, 30 Arms
Deskew Correction Signal Source	701935	Approx. 0 to 5 V, approx. $-$ 100mA to 0, approx. 15 kHz
Dedicated GO/NO-GO cable	366973	–
Trigger comparison output cable	701976	–
Rack mount kit	701984-01	For EIA
Rack mount kit	701984-02	For JIS

### Spare Parts (Sold Separately)

The spare parts below are available for purchase separately.

For information about the spare parts and ordering, contact your dealer.

Part Name	Part No.	Minimum Q'ty	Remarks
Printer roll paper	B9988AE	10	Thermo-sensible paper, 111 mm $\times$ 10 m

---

# Safety Precautions

This instrument is an IEC protection class I instrument (provided with terminal for protective earth grounding).

The general safety precautions described herein must be observed during all phases of operation. If the instrument is used in a manner not specified in this manual, the protection provided by the instrument may be impaired. Yokogawa Electric Corporation assumes no liability for the customer's failure to comply with these requirements.

## The Following Symbols Are Used on This Instrument.



Warning: handle with care. Refer to the user's manual or service manual.

This symbol appears on dangerous locations on the instrument which require special instructions for proper handling or use. The same symbol appears in the corresponding place in the manual to identify those instructions.



Protective ground terminal



Functional ground terminal (do not use this terminal as a protective ground terminal.)



Alternating current



Direct current



ON (power)



OFF (power)



Stand-by



In-position of a bi-stable push control



Out-position of a bi-stable push control

**Make sure to comply with the precautions below. Not complying might result in injury or death.**

---

**WARNING**

**Use the Correct Power Supply**

Before connecting the power cord, ensure that the source voltage matches the rated supply voltage of the DL9000 and that it is within the maximum rated voltage of the provided power cord.

**Use the Correct Power Cord and Plug**

To prevent the possibility of electric shock or fire, be sure to use the power cord supplied by YOKOGAWA. The main power plug must be plugged into an outlet with a protective earth terminal. Do not invalidate this protection by using an extension cord without protective earth grounding.

**Connect the Protective Grounding Terminal**

Make sure to connect the protective earth to prevent electric shock before turning ON the power. The power cord that comes with the instrument is a three-pin type power cord. Connect the power cord to a properly grounded three-pin outlet.

**Do Not Impair the Protective Grounding**

Never cut off the internal or external protective earth wire or disconnect the wiring of the protective earth terminal. Doing so poses a potential shock hazard.

**Do Not Operate with Defective Protective Grounding or Fuse**

Do not operate the instrument if the protective earth or fuse might be defective. Make sure to check them before operation.

**Do Not Operate in an Explosive Atmosphere**

Do not operate the instrument in the presence of flammable liquids or vapors. Operation in such environments constitutes a safety hazard.

**Do Not Remove Covers**

The cover should be removed by YOKOGAWA's qualified personnel only. Opening the cover is dangerous, because some areas inside the instrument have high voltages.

**Ground the Instrument before Making External Connections**

Securely connect the protective grounding before connecting to the item under measurement or an external control unit. If you are going to touch the circuit, make sure to turn OFF the circuit and check that no voltage is present. To prevent the possibility of electric shock or an accident, connect the ground of the probe and input connector to the ground of the item being measured.

---

**Make sure to comply with the precautions below. There are limitations to the operating environment.**

---

**CAUTION**

This product is a Class A (for industrial environment) product. Operation of this product in a residential area may cause radio interference in which case the user is required to correct the interference.

---



---

# Waste Electrical and Electronic Equipment



## **Waste Electrical and Electronic Equipment (WEEE), Directive 2002/96/EC**

(This directive is only valid in the EU.)

■ This product complies with the WEEE Directive (2002/96/EC) marking requirement. This marking indicates that you must not discard this electrical/electronic product in domestic household waste.

### Product Category

With reference to the equipment types in the WEEE directive Annex 1, this product is classified as a "Monitoring and Control instrumentation" product.

Do not dispose in domestic household waste. When disposing products in the EU, contact your local Yokogawa Europe B. V. office.

---

# Symbols and Notation Used in This Manual

## Safety Markings

The following markings are used in this manual.



*Improper handling or use can lead to injury to the user or damage to the instrument.* This symbol appears on the instrument to indicate that the user must refer to the user's manual for special instructions. The same symbol appears in the corresponding place in the user's manual to identify those instructions. In the manual, the symbol is used in conjunction with the word "WARNING" or "CAUTION."

### **WARNING**

Calls attention to actions or conditions that could cause serious or fatal injury to the user, and precautions that can be taken to prevent such occurrences.

### **CAUTION**

Calls attentions to actions or conditions that could cause light injury to the user or damage to the instrument or user's data, and precautions that can be taken to prevent such occurrences.

### **Note**

Calls attention to information that is important for proper operation of the instrument.

## Subheadings

On pages that describe the operating procedures in chapters 3 through 18, the following symbols are used to distinguish the procedures from their explanations.

### **Procedure**

Carry out the procedure according to the step numbers. All procedures are written with inexperienced users in mind; experienced users may not need to carry out all the steps.

### **Explanation**

This section describes the setup items and the limitations regarding the procedures. It may not give a detailed explanation of the function. For a detailed explanation of the function, see chapter 2.

## Notation of Characters

- Bold characters used in the procedural explanations indicate characters that are marked on the panel keys or the characters of the soft keys displayed on the screen menu.
- The SHIFT+xxx key refers to first pressing the SHIFT key (the SHIFT key indicator lights), and then pressing the xxx key. The menu marked in purple above the pressed key appears on the screen.

## Unit

- k: Denotes 1000.      Example: 100 kS/s (sample rate)  
K: Denotes 1024.      Example: 720 KB (storage capacity of a floppy disk)

# Flow of Operation

The figure below is provided to familiarize the first-time user with the general flow of the DL9000 operation. For a description of each item, see the relevant section or chapter.

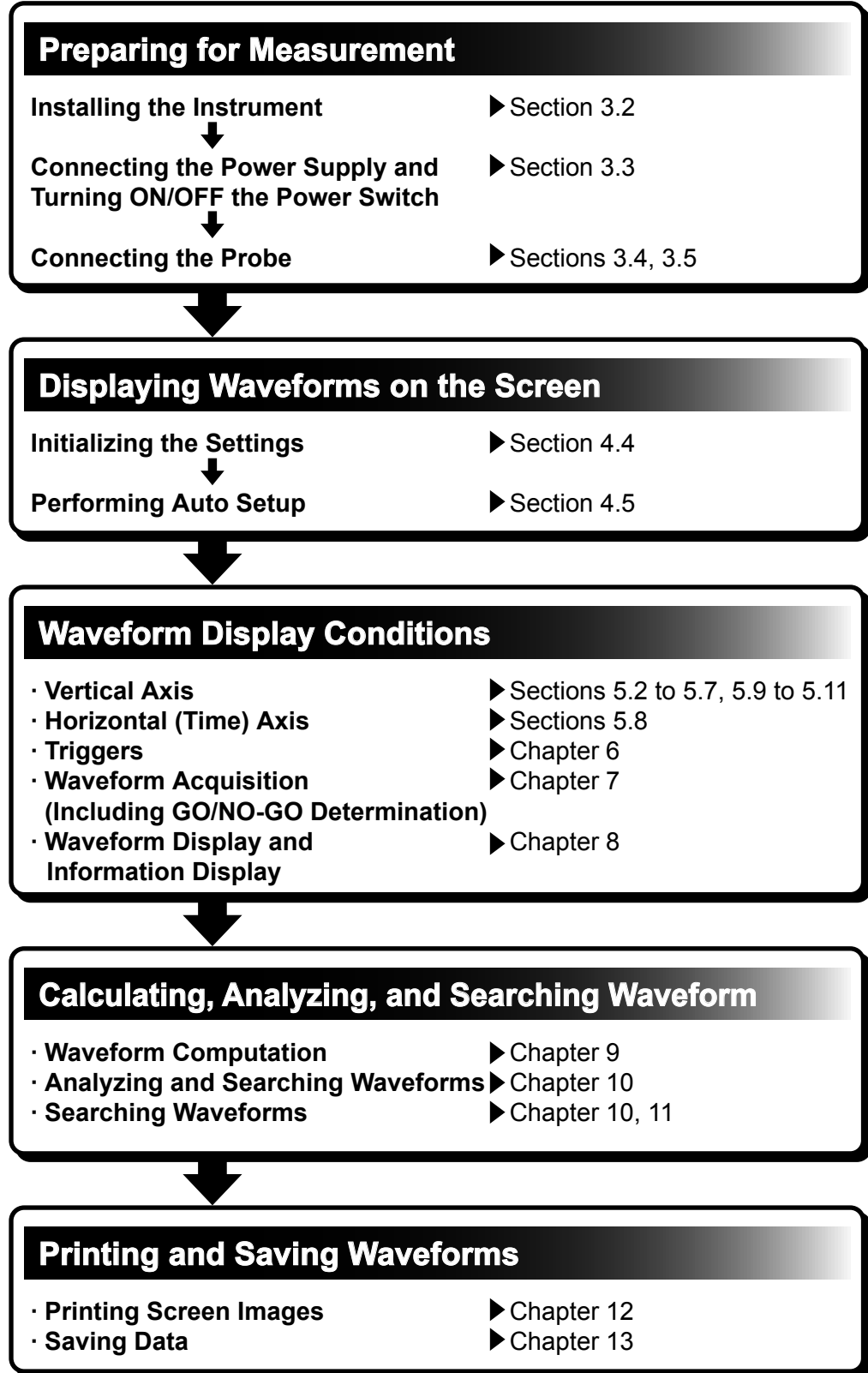

---

# Contents

Checking the Contents of the Package.....	ii
Safety Precautions.....	v
Waste Electrical and Electronic Equipment.....	vii
Symbols and Notation Used in This Manual.....	viii
Flow of Operation.....	ix



## Chapter 1 Names and Functions of Parts

1.1 Top Panel, Front Panel, and Rear Panel.....	1-1
1.2 Operating Keys and Knobs.....	1-3
1.3 Screen Display.....	1-6

## Chapter 2 Explanation of Functions

2.1 Block Diagram.....	2-1
2.2 Channels and Displayed Waveforms.....	2-2
2.3 Vertical and Horizontal Axes.....	2-3
2.4 Triggers.....	2-7
2.5 Waveform Acquisition Conditions.....	2-16
2.6 Display Conditions.....	2-21
2.7 Waveform Computation.....	2-24
2.8 Analyzing and Searching Waveforms.....	2-26
2.9 Communications.....	2-32
2.10 Other Useful Functions.....	2-33

## Chapter 3 Making Preparations for Measurements

3.1 Handling Precautions.....	3-1
3.2 Installing the Instrument.....	3-3
 3.3 Connecting the Power.....	3-5
 3.4 Connecting the Probe.....	3-8
 3.5 Compensating the Probe (Phase Correction).....	3-12
3.6 Setting the Date and Time.....	3-14

## Chapter 4 Basic Operations

4.1 Operations and Functions of Keys and the Rotary Knob.....	4-1
4.2 Entering Values and Strings.....	4-3
4.3 Operating the DL9000 Using a USB Keyboard or a USB Mouse.....	4-5
4.4 Initializing Settings.....	4-9
4.5 Performing Auto Setup.....	4-11
4.6 Storing and Recalling Setting Information.....	4-14
4.7 Starting/Stopping Waveform Acquisition.....	4-16
4.8 Performing Calibration.....	4-17

## Chapter 5 Vertical and horizontal Axes

5.1 Switching the Display of Input Waveforms ON and OFF.....	5-1
5.2 Setting the Offset Voltage.....	5-2
5.3 Setting the Vertical Position of the Waveform.....	5-4
 5.4 Setting the Input Coupling.....	5-5
5.5 Setting Bandwidth Limits.....	5-7
5.6 Setting the Probe Attenuation.....	5-8
5.7 Setting the Scale.....	5-9

5.8	Setting Time Axis (T/div).....	5-10
5.9	Using the Auto Scale Function .....	5-11
5.10	Canceling the Offset Value .....	5-13
5.11	Displaying the Waveform Inverted.....	5-14
5.12	Turning the Display of the Scale Value ON/OFF .....	5-15
5.13	Correcting the Skew .....	5-16

## Chapter 6 Triggers

6.1	Setting the Trigger Mode .....	6-1
6.2	Setting the Trigger Type .....	6-3
6.3	Setting Trigger Coupling/HF Rejection/Trigger Hysteresis/Window Comparator .....	6-7
6.4	Setting the Hold Off Time .....	6-11
6.5	Setting the Trigger Delay .....	6-13
6.6	Setting the Trigger Position .....	6-16
6.7	Activating an Edge Trigger (Edge/State).....	6-18
6.8	Activating a Qualified Edge Trigger (Edge/State).....	6-22
6.9	Activating a Trigger with the State Condition (Edge/State) .....	6-26
6.10	Activating a Trigger by ORing Multiple Edge Triggers (Edge/State).....	6-30
6.11	Activating a Trigger by Pulse Width (Width) .....	6-33
6.12	Activating a Trigger by Qualified Pulse Width (Width).....	6-38
6.13	Activating a Trigger by Width During Which a State Condition Is True (Width).....	6-43
6.14	Activating a Trigger with the Event Cycle (Event Interval).....	6-49
6.15	Activating a Trigger with the Event Delay (Event Interval) .....	6-53
6.16	Activating a Trigger with the Event Sequence (Event Interval) .....	6-58
6.17	Setting the TV Trigger (ENHANCED).....	6-62
6.18	Setting the Trigger Conditions of the Serial Pattern Signal (ENHANCED).....	6-68
6.19	Setting the Trigger Conditions of the I <sup>2</sup> C Bus Signal (ENHANCED) .....	6-73
6.20	Setting the Trigger Conditions of the CAN Bus Signal (ENHANCED).....	6-86
6.21	Setting the Trigger Conditions of the LIN Bus Signal (ENHANCED).....	6-101
6.22	Setting the Trigger Conditions of the SPI Bus Signal (ENHANCED) .....	6-104
6.23	Trigger Settings of the Serial Bus Signal That Are Common to the Settings of the Serial Bus Signal Analysis and Search .....	6-110

## Chapter 7 Acquisition and Display

7.1	Setting the Acquisition Mode .....	7-1
7.2	Turning ON/OFF the High Resolution Mode .....	7-3
7.3	Setting the Record Length.....	7-4
7.4	Turning ON/OFF Repetitive Sampling Mode.....	7-5
7.5	Turning ON/OFF the Interleave Mode .....	7-6
7.6	Turning ON/OFF the Interpolation .....	7-7
7.7	Displaying Accumulation .....	7-8
7.8	Setting the Action-on-Trigger.....	7-11
7.9	Using a GO/NO-GO Determination to Apply an Action-on-Trigger.....	7-16
7.10	Setting the Waveform Zone GO/NO-GO Determination Conditions.....	7-23
7.11	Setting the Rectangular Zone GO/NO-GO Determination Conditions .....	7-29
7.12	Performing GO/NO-GO Determination Using a Polygon Waveform .....	7-33
7.13	Setting the Waveform Parameter GO/NO-GO Determination Conditions .....	7-37
7.14	Setting the FFT Parameter GO/NO-GO Determination Conditions.....	7-41
7.15	Setting the XY Waveform Parameter GO/NO-GO Determination Conditions .....	7-45
7.16	Setting the Telecom Test GO/NO-GO Determination Conditions .....	7-48



**Chapter 8 Display**

8.1 Changing the Display Format..... 8-1  
 8.2 Setting the Interpolation Method ..... 8-3  
 8.3 Changing the Graticule..... 8-5  
 8.4 Adjusting the Backlight ..... 8-6  
 8.5 Setting Waveform Labels ..... 8-8  
 8.6 Taking and Clearing Snapshots..... 8-9  
 8.7 Setting the Waveform Display Color and the Brightness of the Grid, Zoom Box, Cursor, and Marker..... 8-10

**Chapter 9 Computation**

9.1 Linear Scaling..... 9-1  
 9.2 Performing Arithmetic Functions ..... 9-5  
 9.3 Integrating ..... 9-10  
 9.4 Shifting the Phase ..... 9-15  
 9.5 Setting a Filter (IIR Filter) ..... 9-20  
 9.6 Smoothing Waveforms (Using a Moving Average)..... 9-25  
 9.7 Edge Count ..... 9-30  
 9.8 Rotary Count ..... 9-33  
 9.9 User-Defined Computation (Optional)..... 9-37

**Chapter 10 Analyzing and Searching Waveforms**

10.1 Making Cursor Measurements ..... 10-1  
 10.2 Automated Measurement of Waveform Parameters ..... 10-19  
 10.3 Performing Statistical Processing of the Measured Values of Waveform Parameters . 10-29  
 10.4 Zooming the Waveform ..... 10-33  
 10.5 Zooming a Searched Portion..... 10-38  
 10.6 Searching the Serial Pattern ..... 10-50  
 10.7 Telecom Testing..... 10-57  
 10.8 Viewing Phase Differences Between Measured Waveforms (XY display) ..... 10-60  
 10.9 Fast Fourier Transform (FFT)..... 10-65  
 10.10 Displaying Graphs and Lists of Automatic Measurement Waveform Parameters ..... 10-74  
 10.11 Displaying Frequency Distribution for a Specified Area (Accum Histogram)..... 10-85  
 10.12 Automated Measurement of Waveform Parameters of Eye Patterns..... 10-94

**Chapter 11 Displaying and Searching History Waveforms**

11.1 Displaying History Waveforms..... 11-1  
 11.2 Searching the History Waveforms Using Waveform Zones (Wave History Search) ..... 11-6  
 11.3 Searching the History Waveforms Using Rectangular Zones (RECT History Search).. 11-13  
 11.4 Searching History Waveforms Using Automatic Measurements of Waveform Parameters (MEASURE History Search) ..... 11-18  
 11.5 Searching the History Waveforms Using Polygon Waveforms (POLYGON History Search)..... 11-24  
 11.6 Searching the History Waveforms Using the FFT Parameter (FFT History Search)..... 11-29  
 11.7 Searching History Waveform by XY Waveform Parameter (XY History Search) ..... 11-34

**Chapter 12 Printing Screen Images**

12.1 Installing the Roll Paper into the Built-in Printer (Optional) ..... 12-1  
 12.2 Printing Using the Built-in Printer (Optional)..... 12-4  
 12.3 Printing Using a USB Printer ..... 12-5  
 12.4 Printing Using a Network Printer(Optional) ..... 12-8

**Chapter 13 Saving and Loading Data**

13.1	Flash ATA Memory Card .....	13-1
13.2	Connecting a USB Storage Medium to the USB Port .....	13-2
13.3	Connecting to a Network Drive.....	13-3
13.4	Saving/Loading the Setup Data.....	13-4
13.5	Saving/Loading the Measurement Data .....	13-10
13.6	Saving/Loading the Accumulated Waveforms .....	13-19
13.7	Saving/Loading Waveform Zones, Polygon Zones, and Mask Patterns .....	13-25
13.8	Saving Screen Image Data .....	13-30
13.9	Saving Analysis Results .....	13-34
13.10	Changing the File Attributes and Deleting Files .....	13-39
13.11	Copying/Moving Files .....	13-42
13.12	Changing the Directory Name or File Name of the Storage Medium/Creating Directories .....	13-45
13.13	Connecting to a PC Using the USB Port.....	13-48





**Chapter 14 Displaying Reference Waveforms**

14.1	Turning ON/OFF the Reference Waveform Display .....	14-1
14.2	Displaying Stored Data as Reference Waveform .....	14-2
14.3	Displaying Waveforms Inverted.....	14-4
14.4	Saving Data.....	14-5
14.5	Displaying Scale Values and Labels.....	14-6
14.6	Displaying History Waveforms Automatically .....	14-7
14.7	Displaying the Acquisition Time of a Loaded Waveform.....	14-8

**Chapter 15 Ethernet Communications (Optional)**

15.1	Connecting the DL9000 to the Network .....	15-1
15.2	Setting Up the TCP/IP .....	15-3
15.3	Saving and Loading Waveform/Setup/Image Data on a Network Drive.....	15-9
15.4	Setting the Mail Transmission (SMTP Client Function).....	15-12
15.5	Using SNTP to Set the Date and Time.....	15-15
15.6	Accessing the DL9000 from a PC (File Server) .....	15-16
15.7	Monitoring the DL9000's Screen from a PC (Web Server).....	15-19
15.8	Setting Up the Network Printer.....	15-22
15.9	Checking the Presence of the Ethernet Interface.....	15-24
15.10	Configuring a Firewall.....	15-25

**Chapter 16 Rear Panel Input and Output**

	16.1	External Trigger Input (TRIG IN) .....	16-1
	16.2	Trigger Output (TRIG OUT).....	16-2
	16.3	RGB Video Signal Output (RGB VIDEO OUT).....	16-3
	16.4	GO/NO-GO Signal Output.....	16-4
	16.5	Trigger Comparator Signal Output .....	16-6

**Chapter 17 Other Operations**

17.1	Changing the Message Language, Menu Language, and Font Size, and Turning ON/OFF the Click Sound.....	17-1
17.2	Listing the Setup Data .....	17-3
17.3	Changing the USB Keyboard Language .....	17-4

1

2

3

4

5

6

7

8

9

10

11

12

13

14

15

16

17

18

19

App

Index

**Chapter 18 Troubleshooting, Maintenance, and Inspection**

18.1	If a Problem Occurs.....	18-1
18.2	Messages and Corrective Actions .....	18-2
18.3	Carrying Out a Self-Test .....	18-7
18.4	System Overview .....	18-10
18.5	Collectively Deleting the Data in the Internal Memory and Built-in Hard Disk.....	18-11
18.6	Formatting Internal Memory and Built-in Hard Disk .....	18-12
18.7	Recommended Replacement Parts .....	18-13

**Chapter 19 Specifications**

19.1	Models.....	19-1
19.2	Input Section .....	19-1
19.3	Trigger Section.....	19-2
19.4	Time Axis .....	19-5
19.5	Display Section.....	19-5
19.6	Functions.....	19-5
19.7	Built-in Printer (/B5 option) .....	19-8
19.8	Auxiliary Inputs and Outputs .....	19-9
19.9	Storage.....	19-10
19.10	Computer Interfaces.....	19-11
19.11	General Specifications .....	19-12
19.12	External Dimensions .....	19-15

**Appendix**

Appendix 1	Relationship between the Time Axis Setting, Sample Rate and Record Length	App-1
Appendix 2	How to Calculate the Area of a Waveform .....	App-14
Appendix 3	Key Assignments for the USB104 Keyboard.....	App-15
Appendix 4	Waveform Parameter Integrals and Derivatives.....	App-17

**Index**



# 1.1 Top Panel, Front Panel, and Rear Panel

## Top Panel

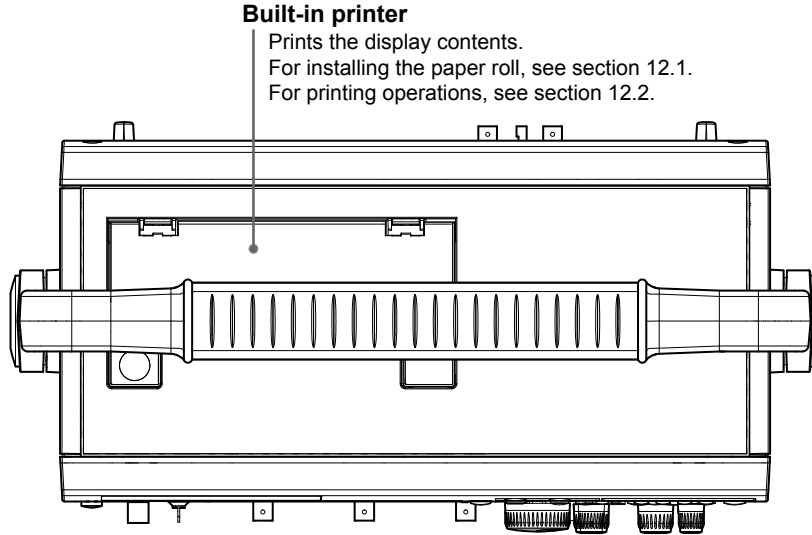

**Built-in printer**

Prints the display contents.  
For installing the paper roll, see section 12.1.  
For printing operations, see section 12.2.

## Front Panel

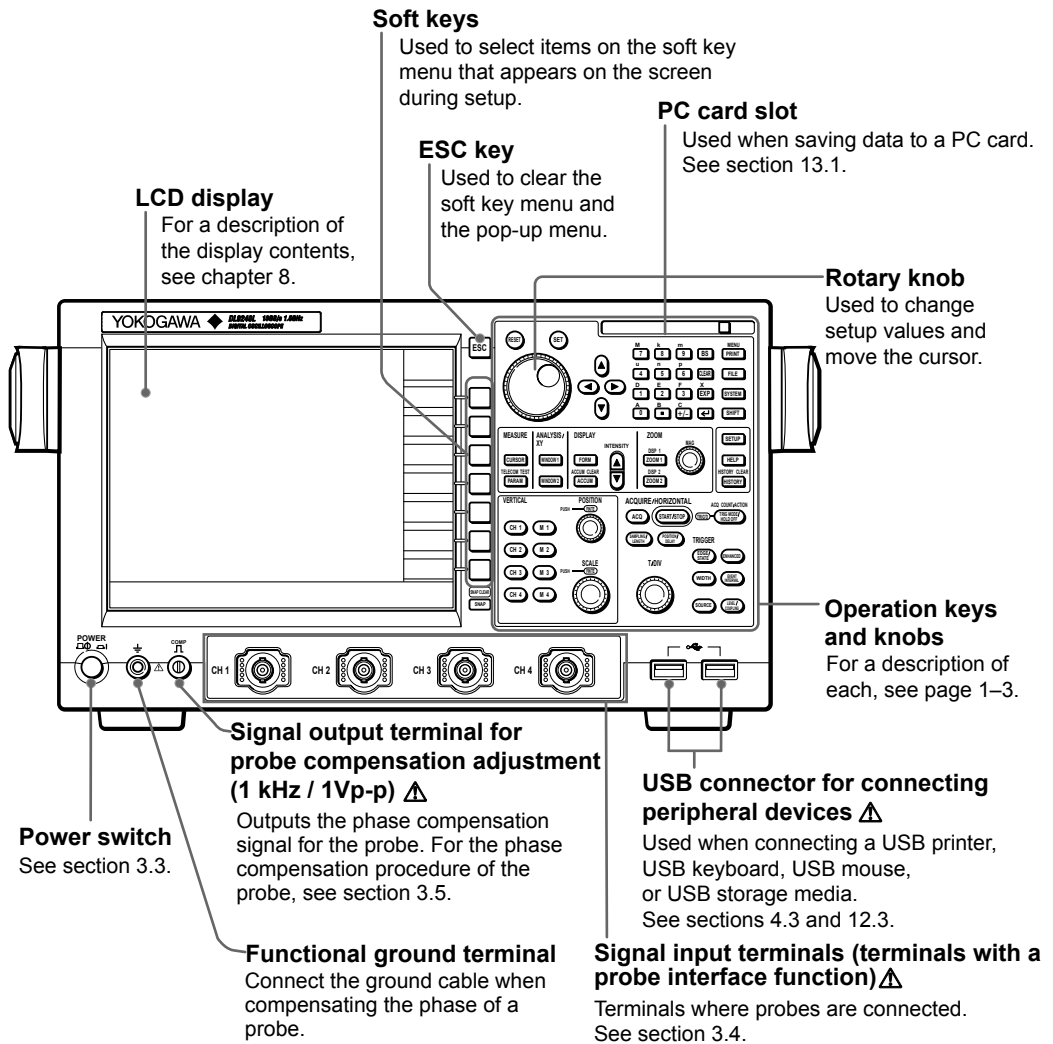

**Soft keys**

Used to select items on the soft key menu that appears on the screen during setup.

**PC card slot**

Used when saving data to a PC card. See section 13.1.

**LCD display**

For a description of the display contents, see chapter 8.

**ESC key**

Used to clear the soft key menu and the pop-up menu.

**Rotary knob**

Used to change setup values and move the cursor.

**Operation keys and knobs**

For a description of each, see page 1–3.

**Signal output terminal for probe compensation adjustment (1 kHz / 1Vp-p)  $\Delta$**

Outputs the phase compensation signal for the probe. For the phase compensation procedure of the probe, see section 3.5.

**USB connector for connecting peripheral devices  $\Delta$**

Used when connecting a USB printer, USB keyboard, USB mouse, or USB storage media. See sections 4.3 and 12.3.

**Power switch**  
See section 3.3.

**Functional ground terminal**

Connect the ground cable when compensating the phase of a probe.

**Signal input terminals (terminals with a probe interface function)  $\Delta$**

Terminals where probes are connected. See section 3.4.

Rear Panel

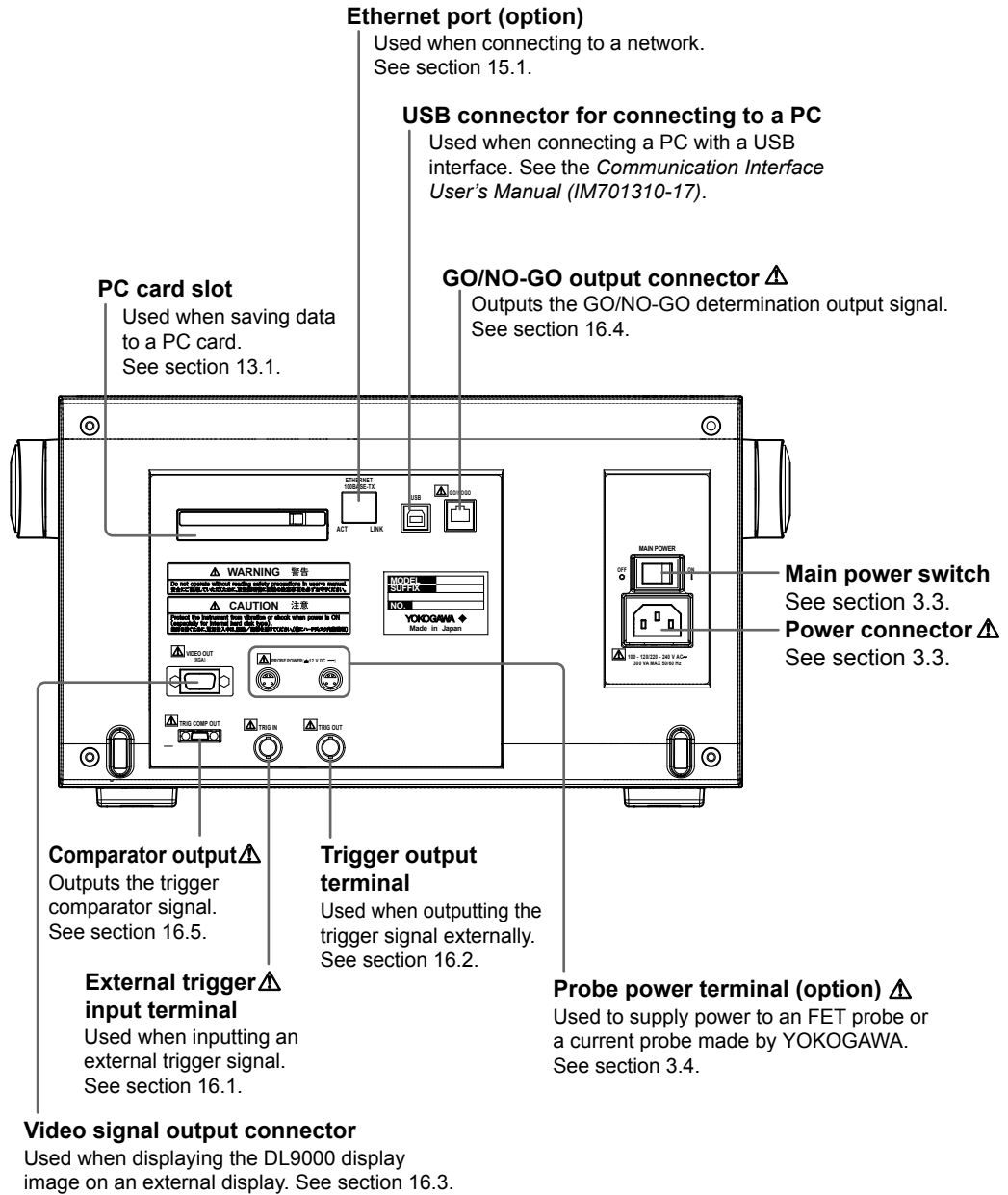

## 1.2 Operating Keys and Knobs

### Vertical Axis, Channel, and Calculation

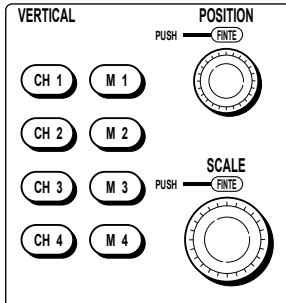

#### CH1 to CH4 keys (Chapter 5)

These display menus for switching the display of each channel ON/OFF, vertical position, coupling, probe type, offset voltage, bandwidth limit, expansion or reduction of the vertical axis, linear scaling, and waveform labels. Pressing one of these keys before using the SCALE knob assigns the corresponding channel to the SCALE knob operation. Each CH key lights when the corresponding channel is ON.

#### M1 to M4 keys (Chapter 9, Chapter 14)

These keys are used for waveform calculation settings, and settings relating to reference waveforms. Each M key lights when the corresponding channel is ON.

#### POSITION knob

Changes the center position when you change the voltage range. This knob has a push switch feature. You can press the knob to switch the setting resolution. If you press the knob and Fine lights, the setting resolution is set to fine.

#### SCALE knob

This sets the vertical axis sensitivity. Before turning this knob, press one of the CH1 to CH4, or M1 to M4 keys, to select the waveform adjusted. If you change this while waveform acquisition is stopped, the change takes effect when waveform acquisition is restarted. This knob includes a push switch, and can be pressed to change the resolution of the setting. When the knob is pressed, lighting the Fine indicator, the resolution is finer.

### Waveform Acquisition and Horizontal Axis

#### ACQ key (Sections 7.1, 7.2)

Displays a menu for setting the method of waveform acquisition.

#### START/STOP key (Section 4.7)

Depending on the trigger mode, this starts/stops waveform acquisition. During waveform acquisition, the key lights.

#### TRIG MODE/HOLD OFF key (Sections 6.1, 7.8)

Displays a menu for selecting the trigger mode. Pressing the SHIFT key before pressing the MODE key displays the action on trigger menu.

#### SAMPLING/LENGTH key (Sections 7.3 to 7.6)

Displays a menu for record length, equivalent time sampling, interleave, and interpolation setting.

#### POSITION/DELAY key (Sections 6.5, 6.6)

Displays a menu for trigger delay and trigger position settings.

#### EDGE/STATE key (Sections 6.7 to 6.10)

Displays a menu for Edge/State trigger settings.

Press one of four keys, including the following ENHANCED key, WIDTH key, and EVENT INTERVAL key, to select the trigger type. The pressed key lights, indicating that it is selected.

#### WIDTH key (Sections 6.11 to 6.13)

Sets the Width trigger.

#### ENHANCED key (Section 6.17 to 6.22)

Displays a menu for TV trigger and serial bus trigger settings.

#### EVENT INTERVAL key (Sections 6.14 to 6.16)

Displays a menu for event trigger settings.

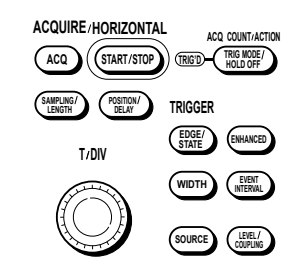

## 1.2 Operating Keys and Knobs

### **SOURCE key (Chapter 6)**

Displays a menu for trigger sources setting.

### **LEVEL/COUPLING key (Section 6.3)**

Displays a menu for trigger coupling, HF rejection, Window comparator, and other settings.

### **T/DIV knob (Section 5.8)**

Sets the time axis scale. If you change this while waveform acquisition is stopped, the change takes effect when waveform acquisition is restarted.

## **Waveform Analysis/Screen Display/Screen Image Printing/Data Saving/History Waveform/etc.**

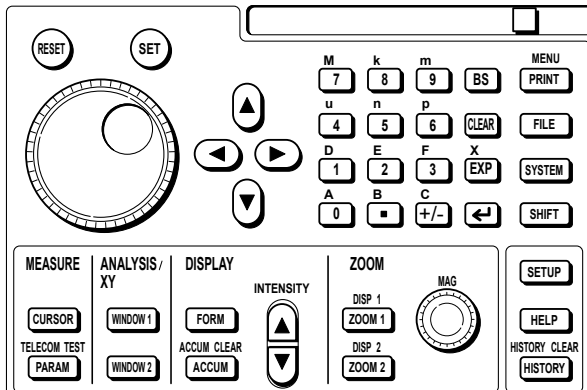

### **Waveform Analysis**

#### **CURSOR key (Section 10.1)**

Displays a menu for cursor measurement.

#### **PARAM key (Sections 10.2 to 10.3), (SHIFT+) PARAM key (Sections 10.7, 10.12)**

Displays a menu for automatic waveform parameter measurement and statistics processing. Pressing the SHIFT key, followed by the PARAM key displays a menu for the telecom test.

#### **WINDOW1 key and WINDOW2 key (Sections 10.8 to 10.11)**

Display a menu for XY display, FPT analysis, waveform parameter histogram and list, and other settings. When the display is ON, the key lights.

### **Screen Display**

#### **FORM key (Sections 8.1 to 8.4)**

Displays a menu relating to screen display.

#### **(SHIFT+) ACCUM key (Section 7.7)**

Displays a menu for waveform overwriting display. Pressing the SHIFT key, followed by the ACCUM key clears the overwriting waveform.

#### **(SHIFT+) ZOOM1 and ZOOM2 keys (Sections 10.4 to 10.6)**

Display a menu for waveform zoom display and data search functions. Pressing the SHIFT key, followed by the ZOOM key displays a menu relating to zoom waveform positioning.

#### **MAG dial (Section 10.4)**

In a zoom display, turn this dial to change the zoom ratio on the applicable vertical/horizontal axis.

**Screen Image Printing/Data Saving/History Waveform/etc.****RESET key**

Returns a numeric input value to its default.

**SET key**

Confirms a menu item selected with the rotary knob.

**Arrow keys ( ◀ ▶ ▲ ▼ keys)**

The left and right arrow keys move the digit cursor sideways when entering a numeric value.

Use the up and down arrow keys to enter a numeric value.

**Numeric keypad**

Use this for entering numeric values, file names, and so on.

**(SHIFT+) PRINT key (Sections 12.2 to 12.4, 13.8)**

Prints the screen image data. Pressing the SHIFT key, followed by the PRINT key displays a menu when printing the screen image data to the internal printer or USB printer.

**FILE key (Sections 13.4 to 13.7, 13.9 to 13.12)**

Displays a menu for data saving and recall operations using a PC card or USB memory, and for file operations.

**SYSTEM key**

Displays a menu relating to calibration, network, computer interface settings, date and time, message language, click sound, self-test, and storage media formatting.

Displays system information (which options are installed, and firmware version).

**SHIFT key**

Pressing this once lights the key, and enables the functions indicated on each key by a purple legend above the key. Pressing the key once more returns to the normal functions.

**SETUP key (Section 4.5)**

Displays a menu for the initialization function returning settings to their factory defaults, the auto setup function automatically setting values according to input signals, and for storing and recalling setting information.

**(SHIFT+) HISTORY key (Chapter 11)**

Displays a menu for displaying waveforms using the history memory function, and when searching. Pressing the SHIFT key, followed by the HISTORY key clears the displayed history waveform.

# 1.3 Screen Display

## Normal Display Screen

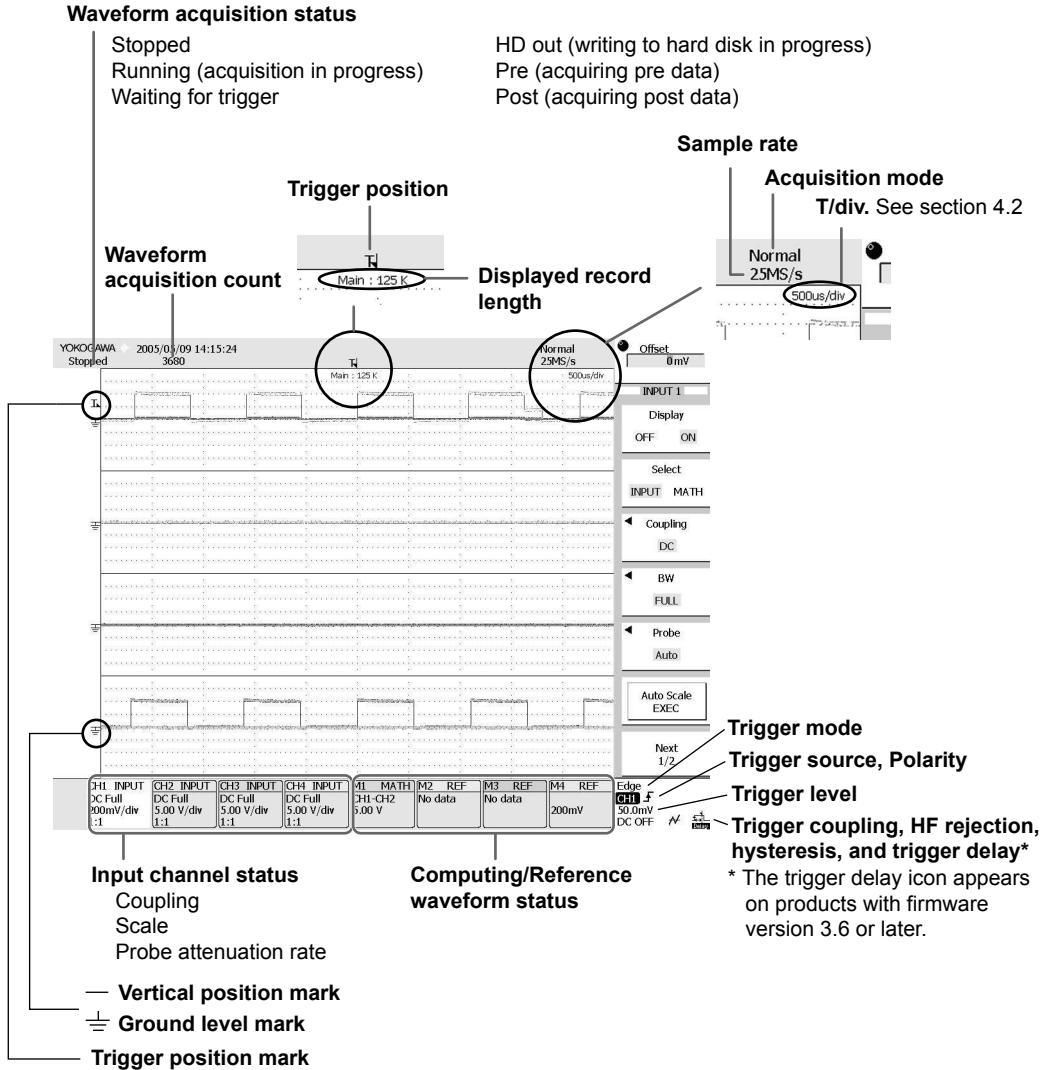

### Acquisition Mode Display

- Normal: Normal mode
- Envelope: Envelope mode
- Average: Average mode

### Note

The LCD screen of this instrument may have a number of defective pixels.

### Screen Displaying Zoom Waveforms

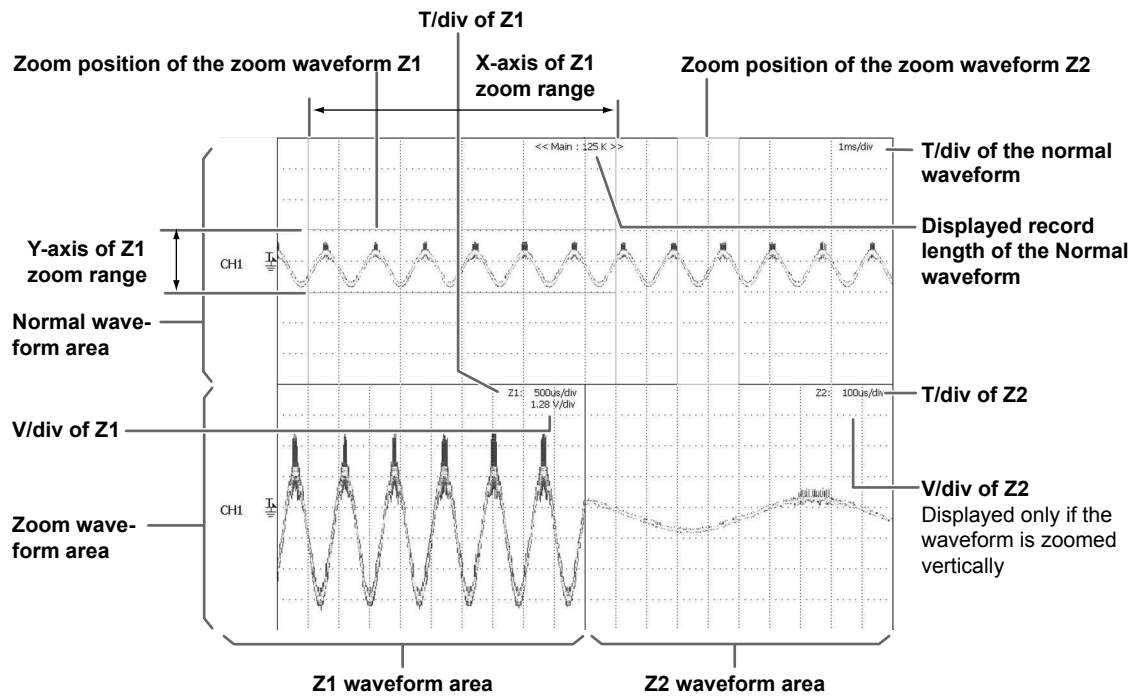

### Screen Displaying the Analysis Result

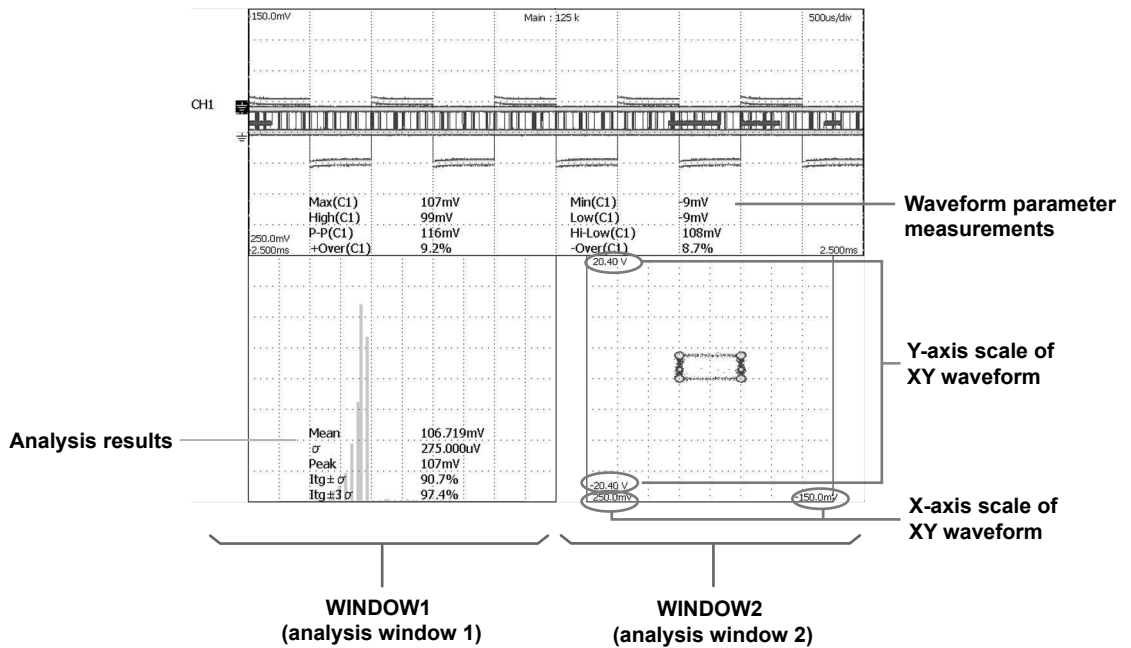

# 2.1 Block Diagram

## System Configuration

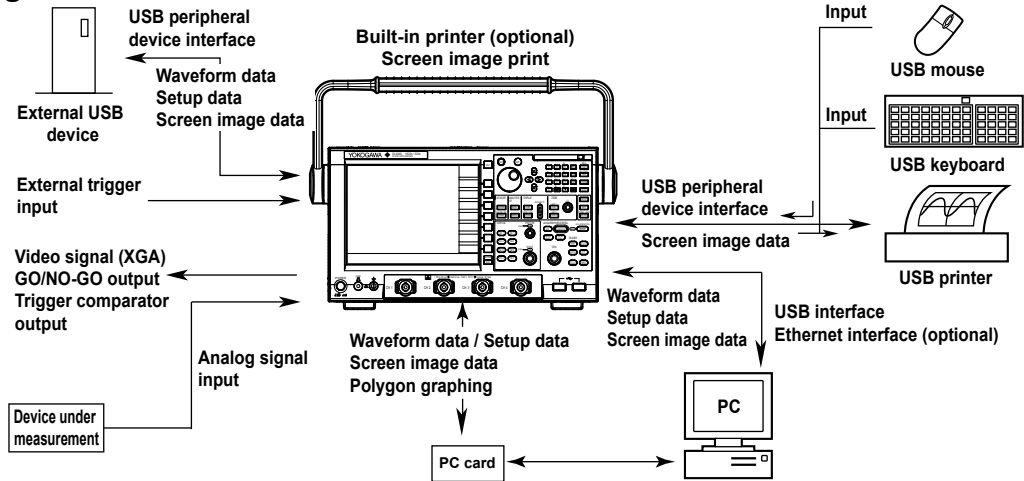

## Block Diagram

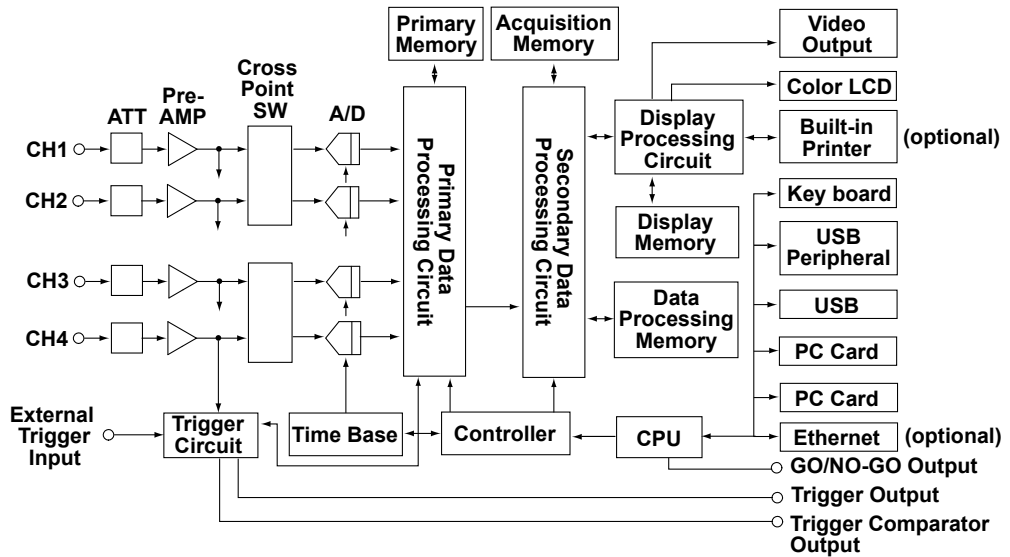

### Signal Flow

The signal applied to each signal input terminal is first passed to the vertical control circuit consisting of an attenuator (ATT) and pre-amplifier. At the attenuator and pre-amplifier, the amplitude of each input signal is adjusted according to the settings such as the input coupling, voltage sensitivity (Scale), and offset voltage. The adjusted input signal is then passed to the cross-point switch. The signal input to the cross-point switch is passed to the A/D converter according to the interleave setting.

At the A/D converter, the received voltage level is converted into digital values. The digital data is written to the primary memory by the primary data processing circuit at the sample rate that matches the time axis setting.

When the trigger is applied, data written to the primary memory is transferred to the acquisition memory.

The data written to the acquisition memory is converted into waveform display data by the secondary data processing circuit, transferred to the waveform processing circuit, and stored in the display memory. The waveforms are displayed on the LCD using the data stored in the display memory.



---

## 2.2 Channels and Displayed Waveforms

There are three types of waveform that can be displayed on the DL9000.

- Input waveforms
- Computed waveforms
- Reference waveforms

The reference waveform can be selected from input waveforms, computed waveforms, and previously stored input or computed waveforms.

The DL9000 provides the following channels.

- Input channels (CH1 to CH4)
- Computation channels (M1 to M4)

By assigning a waveform to each channel, the assigned waveforms can be displayed.

Depending on the channel type, different waveforms can be assigned as follows.

Input channels: Measurement waveforms currently being captured, computed waveforms

Computation channels: Computed waveforms, reference waveforms

---

### **Note**

If a computed waveform is assigned to an input channel, it is displayed as MATH5 to MATH8.

---

### **Input Waveforms**

These are waveforms for measurement input to an input channel.

### **Computed Waveforms**

These are waveforms computed from input waveforms or reference waveforms.

In the calculation equation that can be set in the menu for channels 1 to 4 is fixed, being the input waveform of the input channel being set. When a calculation is set in the menu for channels 1 to 4, the data of the channel for which the calculation is set is the calculation value.

For details of computations, see page 2-24.

---

### **Note**

To use a calculated result as a source for a different calculation equation, set the calculation equation in the menu for channels 1 to 4, then use that result (one of channels 1 to 4) as the source in the separate calculation formula.

---

### **Reference Waveforms**

Any of input waveforms, other computed waveforms, and previously stored input or computed waveforms can be selected for display. The history information for the selected waveform is also read in.

It is also possible to make a separate selection from the history waveforms to display only one, or to display all of the history waveforms superimposed.

A history waveform refers to any previous waveform stored in acquisition memory.

For details of history waveforms, see Chapter 11.

## 2.3 Vertical and Horizontal Axes

The vertical sensitivity setting is used to adjust the displayed amplitude of the waveform for easy viewing. The vertical sensitivity is set by assigning a voltage or a current value to one grid square (1 division) on the screen.

By switching attenuators with different attenuation and changing the amplification of the pre-amplifier, the sensitivity changes in steps (for example, voltage sensitivity changes in steps as in 1 V/div, 2 V/div, and 5 V/div).

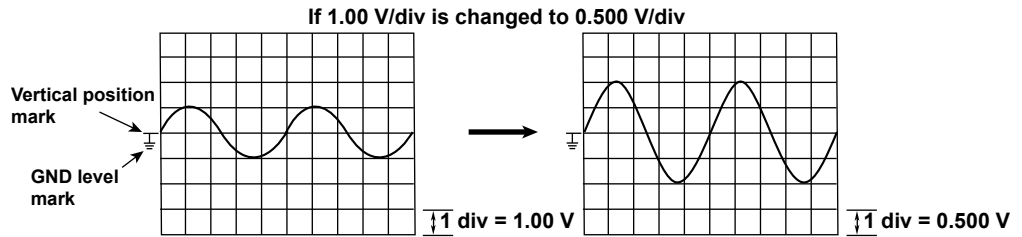

### Note

#### Vertical Sensitivity Setting and Measurement Resolution

To measure a voltage with high precision, the vertical sensitivity should be adjusted so that the input signal is measured with as large an amplitude as possible.

The DL9000 uses 8-bit A/D converters to sample the input signal at a resolution of 250 levels (LSB). The waveforms are displayed using 25 levels per division.

#### Valid Data Range

The output with 250 levels as described above is displayed at 25 levels per division, and therefore the effective display range is  $\pm 5$  divisions from the center of the screen. However, if the vertical axis position is moved after stopping data (waveform) acquisition, the valid data range also moves by the same amount.

### Vertical Position of the Waveform <<For the procedure, see Section 5.3>>

Since the DL9000 can display eight waveform channels, including computation channels, the waveforms are displayed superimposed, and can be difficult to read.

In this case, you can change the display position of waveforms on the vertical axis (vertical position) in the range of  $\pm 4$  divisions for easier viewing. The vertical sensitivity switches around the vertical position (mark).

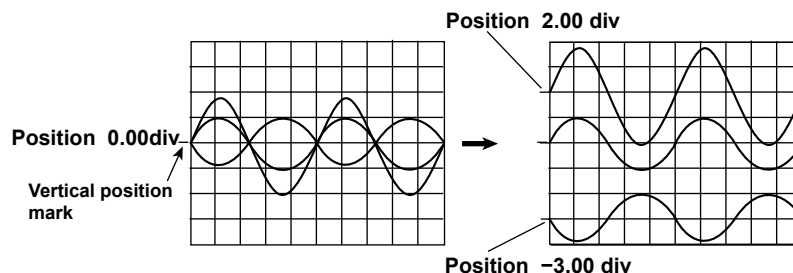

**Input Coupling <<For the procedure, see Section 5.4>>**

If you wish to observe just the amplitude of an AC signal, it is best to remove the DC component from the input signal. On the other hand, there are times when you wish to check the ground level or observe the entire input signal (both the DC and AC components). In these cases, you can change the input coupling setting. By changing the input coupling, the method used to input the signal to the vertical control circuit (voltage axis) is switched. The following types of input coupling are available.

**AC1 MΩ**

The input signal is coupled to the attenuator of the vertical control circuit through a capacitor. This setting is used when you wish to observe only the amplitude of the AC signal, eliminating the DC component from the input signal.

**DC1 MΩ**

The input signal is directly coupled to the attenuator of the vertical control circuit. Use this setting if you wish to observe the entire input signal (DC component and AC component).

**DC50 Ω**

The same as for DC1 MΩ above, except that the input impedance is 50 Ω. Care is required, as this reduces the maximum input voltage.

**GND**

The input signal is not coupled to the attenuator of the vertical control circuit, which is connected to ground. You can use this setting to check the ground level on the screen.

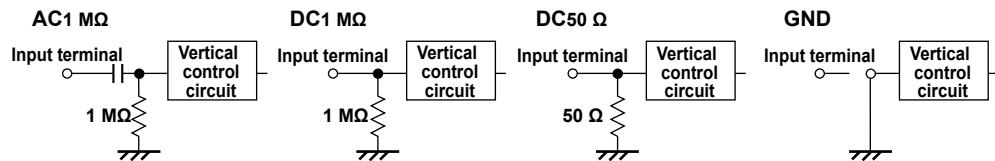

**Probe Attenuation/Current-to-Voltage Conversion Ratio <<For the procedure, see Section 5.6>>**

Normally a probe is used in connecting the circuit being measured to the measurement input terminal. Using a probe has the following advantages.

- Avoids disturbing the voltage and current of the circuit being measured.
- Inputs the signal with no distortion.
- Expands the voltage range that the DL9000 can measure.

The DL9000 is supplied with 500 MHz passive probes. The supplied probe attenuates the measured voltage signal by a factor of 1/10. When using the probe, in order to read the measurement voltage correctly, the attenuation setting on the DL9000 must be set to match the probe attenuation. The DL9000 automatically recognizes when the supplied 500 MHz passive probes (voltage probes) are connected, and sets the attenuation ratio to 10 : 1.

In addition to the 10 : 1 setting, the DL9000 has settings for a voltage probe of 1 : 1, 100 : 1, and 1000 : 1, and for a current probe settings of 1A : 1V\*, 10 A : 1 V and 100 A : 1 V. When using probes, set the attenuation ratio to match that of the probe.

\* 1A:1V supported by firmware version 2.40 or later

### Offset Voltage <<For the procedure, see Section 5.2>>

When observing a signal superimposed on a predetermined voltage, an offset voltage can be applied to eliminate the predetermined voltage so that only the changes in the signal can be observed with higher vertical axis sensitivity.

Usually, the offset voltage does not affect the cursor measurement values, the result of the automated measurement of waveform parameters, or the computed values. However, by setting Offset Cancel to ON (see section 5.10), you can calculate with the offset voltage subtracted from cursor measurement values, results of the automated measurement of waveform parameters, and computed values.

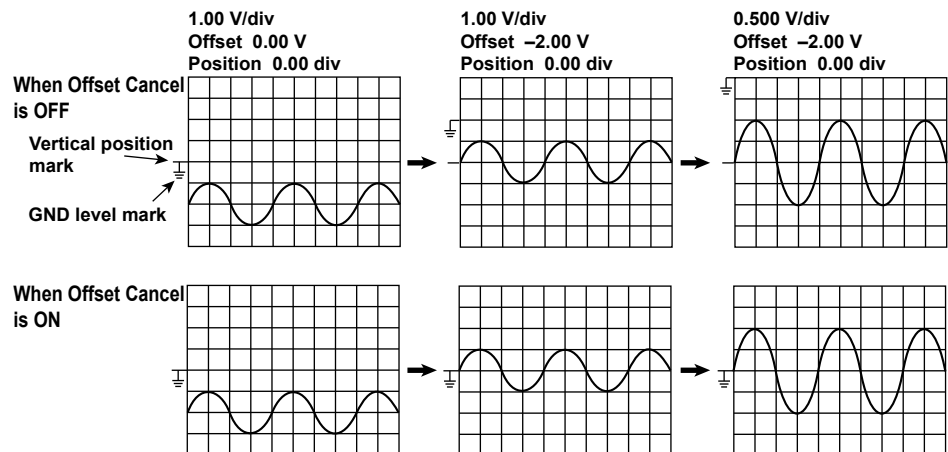

### Inverted Waveform Display

This inverts the waveform display about the Position value as center. The inversion applies to the display only, and does not affect the measurement value. Setting the inverted display ON/OFF does not affect waveform parameter automatic measurement values or calculations.

### Bandwidth Limit <<For the procedure, see Section 5.5>>

Input signals can have bandwidth limits above a certain frequency set independently for each channel. You can observe waveforms with the noise components above the specified frequency eliminated. The frequency can be selected from FULL, 200 MHz, 20 MHz, 8 MHz, 4 MHz, 2 MHz, 1 MHz, 500 kHz, 250 kHz, 125 kHz, 62.5 kHz, 32 kHz, 16 kHz, and 8 kHz.

### Horizontal Axis (Time Axis)

#### Time Axis Setting <<For the procedure, see Section 5.8>>

The time axis scale (T/div) is set as time per grid square (1 div). The setting range is from 500ps/div to 50s/div. Since horizontal axis display range is 10 div, the waveform display time is  $T/\text{div} \times 10$ .

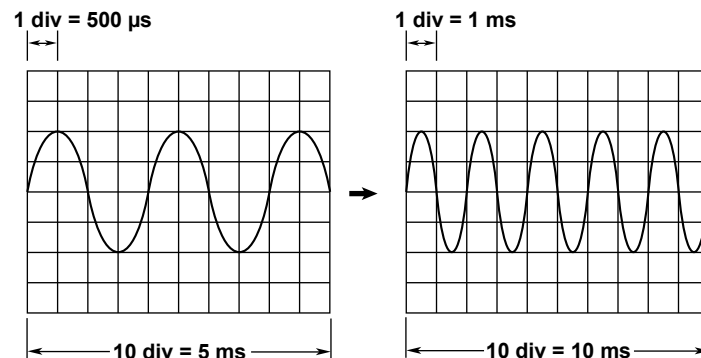

**Relationship between the Specified Record Length, Time Axis Setting, Sample Rate, and Display Record Length**

If you change the time axis setting with respect to the specified record length of the acquisition memory, the sample rate and display record length change. For more details about this relationship, see Appendix 1.

**Time Axis Setting and Roll Mode Display**

If T/div is set to a certain range (see Appendix 1), instead of the displayed waveform being updated by a trigger (update mode), the waveform is displayed in roll mode. In roll mode, as new data is captured, the oldest values are deleted from the screen, as the waveform scrolls from right to left. Thus roll mode display allows waveforms to be observed in the same way as on a pen recorder. It is useful in observing low frequency signals or signals that change slowly. It is also useful in detecting glitches (spikes in the waveform) that occur intermittently.

\* Roll mode display is also used when the trigger mode is set to single. However, the displayed waveforms stop when a trigger is activated.

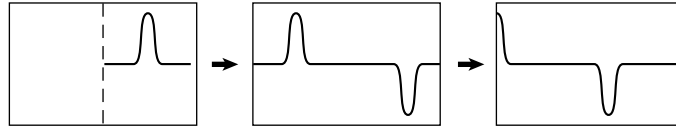

## 2.4 Triggers

A trigger is a cue used to display the waveform on the screen. The trigger is activated when the specified trigger condition is met. At this point, the waveform is ready to be displayed on the screen.

### Trigger Source, Trigger Slope, and Trigger Level

#### Trigger source

Trigger source refers to the signal that is used in checking the trigger condition.

#### Trigger slope

Trigger slope refers to the movement of the signal from a low level to a high level (rising edge) or from a high level to a low level (falling edge). When a slope is used as one of the trigger conditions, it is called a trigger slope.

#### Edge

The term “edge” is used to refer to the point at which the trigger source slope passes the trigger level (or if trigger hysteresis is set, the point at which it has passed the level by the hysteresis amount).

#### Trigger level

Trigger level refers to the level at which a trigger is activated when the trigger source passes the certain level.

With simple triggers such as the edge trigger described later, a trigger is activated when the level of the trigger source passes through the specified trigger level.

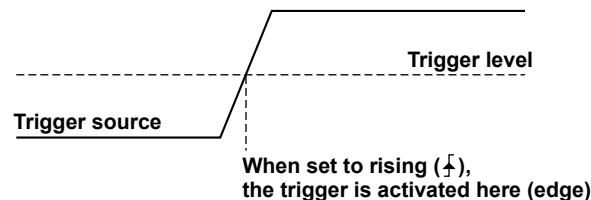

### Trigger Type <<For the procedure, see Chapter 6>>

The DL9000 provides three basic trigger types: “Edge/State,” “Width,” and “Enhanced.” Then by setting “Event Interval,” a trigger can be applied that is dependent on the period of a recurring trigger condition, or the time interval between two triggers.

#### Edge/State trigger

There are four types of Edge/State trigger, as follows.

- **Edge trigger**

When the trigger source passes through the specified trigger level on a rising or falling edge, a trigger is activated. You can select the trigger source from input signals, the external trigger signal, and the commercial power supplied to the DL9000. In the case of commercial power, a trigger is activated only on the rising edge.

## 2.4 Triggers

- **Edge (Qualified) trigger**

Activates a trigger on the edge of a single trigger source while the input signal states meet the specified qualify conditions.

**Qualify: CH1 = H, CH2 = L, AND, Trigger source: CH3, rising**  
**L: low level, H: high level**

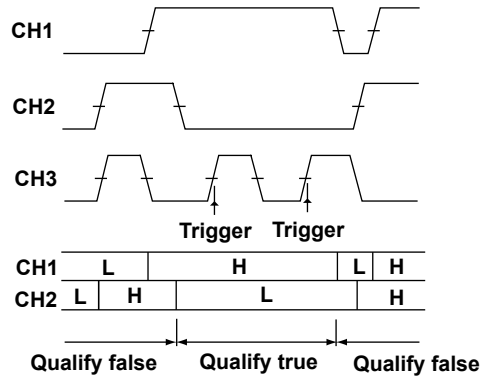

- **State trigger**

A trigger is activated in any of the following cases.

- When the state condition is met or ceases to be met.
- The DL9000 checks the state condition at the rising or falling edge of the specified signal (clock signal) and normalizes the result (high if the state condition is met or low if not). A trigger is activated when the normalized condition changes.

**State: CH1 = H, CH2 = L, CH3/CH4 = X, AND**  
**Clock: None, Polarity: Enter**  
**L: low level, H: high level**

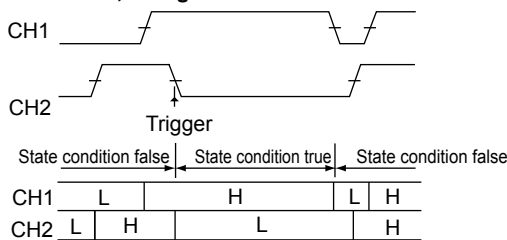

**State: CH1 = H, CH2 = L, CH3/CH4 = X, AND**  
**Clock: None, Polarity: Exit**  
**L: low level, H: high level**

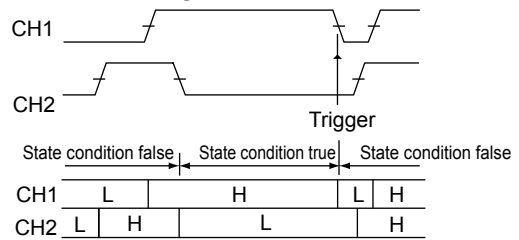

**State: CH1 = H, CH2 = L, CH4 = X, AND**  
**Clock: CH3, rising, Polarity: Enter**  
**L: low level, H: high level**

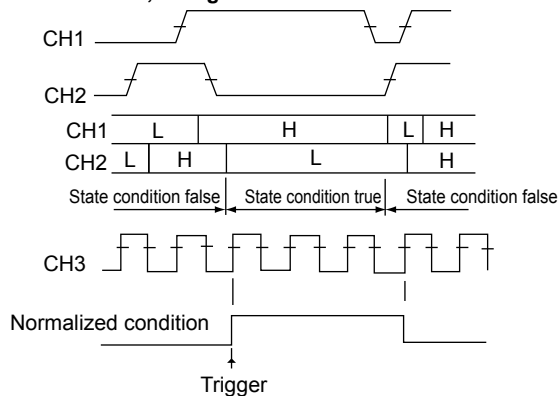

**State: CH1 = H, CH2 = L, CH4 = X, AND**  
**Clock: CH3, rising, Polarity: Exit**  
**L: low level, H: high level**

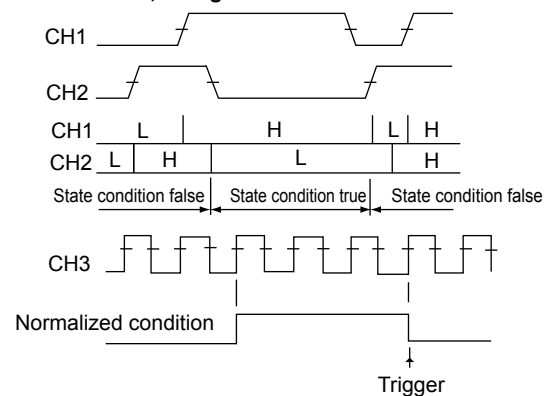

• **Edge OR trigger**

A trigger is activated by an edge on multiple trigger sources. When an Edge OR trigger is used, the frequency of the trigger sources is limited to 200 MHz or less.

**Width**

A trigger is activated by the duration of a pulse (pulse width). There are three types of width trigger, as follows.

• **Pulse trigger**

A trigger is activated according to the relationship of the pulse width of the single trigger source and the specified time.

- At the end of a pulse longer than the specified time (More than)
- At the end of a pulse shorter than the specified time (Less than)
- At the end of a pulse longer than specified time T1 and shorter than specified time T2 (Between)
- At the end of a pulse either shorter than specified time T1 or longer than specified time T2 (Out of range)
- A trigger when the pulse width exceeds the specified time (Time out)

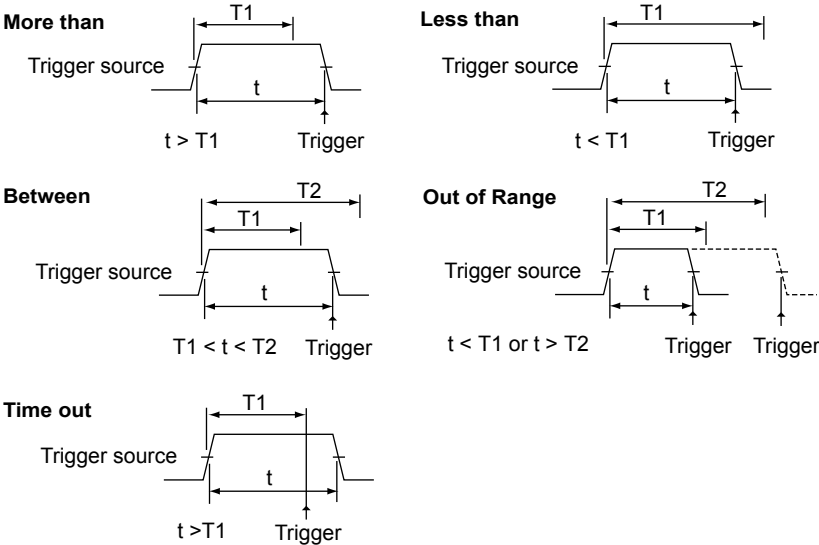

• **Pulse (Qualified) trigger**

A trigger is activated on the relationship between the pulse width of a single trigger source and a specified time while the input signal states meet the specified qualify conditions. The timing at which the trigger is activated is the same as for Pulse trigger.

**State: CH1 = H, CH2 = L, AND, Trigger source: CH3, falling, More than**  
**L: low level, H: high level**

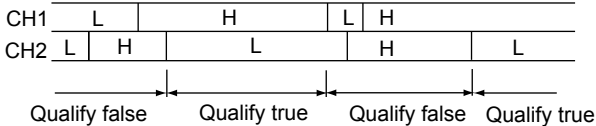
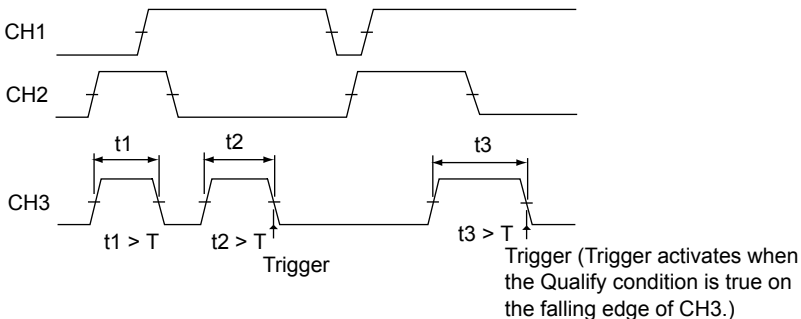



## 2.4 Triggers

- **Pulse State trigger**

A trigger is activated in any of the following cases.

- When the time during which the state condition is met or not met satisfies the relationship with the specified determination time.
- The DL9000 checks and normalizes the state condition on the rising or falling edge of the specified signal (clock source). A trigger is activated when the time during which the normalized condition is met or not met first satisfies the relationship with the specified time.

**State: CH1 = H, CH2 = L, CH3/CH4 = X, AND**  
**Clock: None, Polarity: True, More than**  
**L: low level, H: high level**

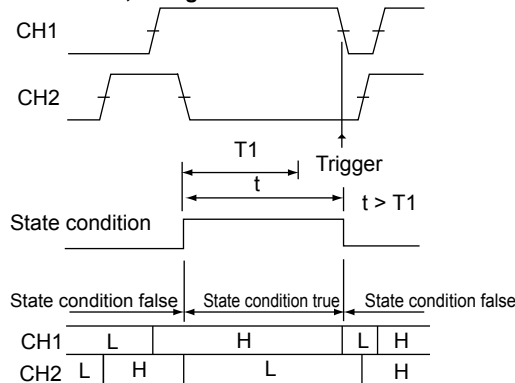

**State: CH1 = H, CH2 = L, CH3/CH4 = X, AND**  
**Clock: None, Polarity: False, More than**  
**L: low level, H: high level**

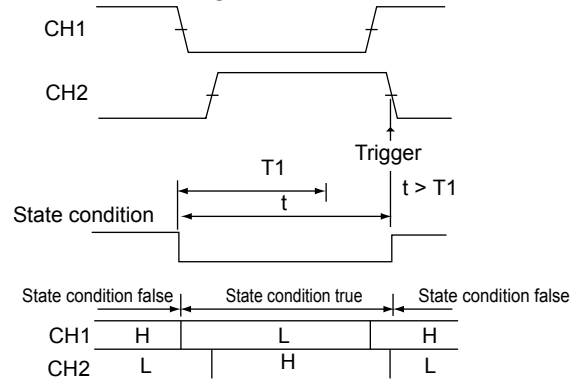

**State: CH1 = H, CH2 = L, CH4 = X, AND**  
**Clock: CH3, rising, Polarity: True**  
**L: low level, H: high level**

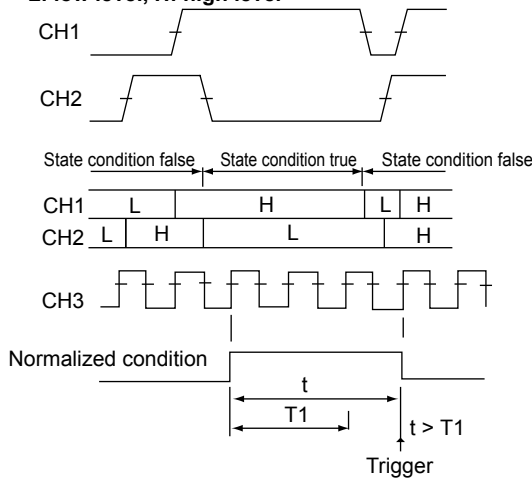

**State: CH1 = H, CH2 = L, CH4 = X, AND**  
**Clock: CH3, rising, Polarity: False**  
**L: low level, H: high level**

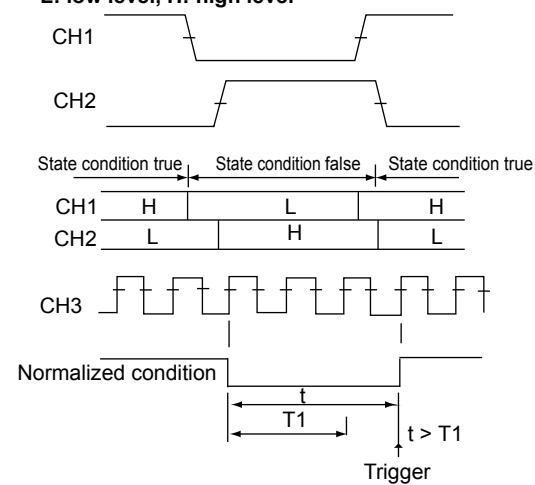

### Enhanced

- **TV trigger**

This trigger is used when observing a video signal. NTSC (525/60/2), PAL (625/50/2), and HDTV (1125/60/2) standards are supported. The horizontal sync signal can be set to any frequency, allowing a trigger to be taken from any TV signal, not necessarily one of the above standards.

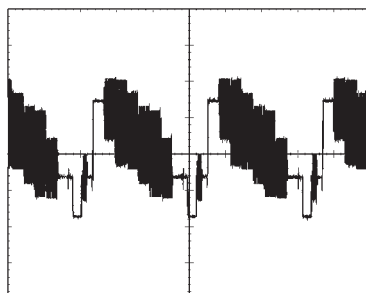

- **Serial**

This is a trigger function for capturing serial pattern signals. This function can be used on products with firmware version 1.60 or later.

This function detects the serial data pattern in sync with the selected clock signal. You can specify a serial data pattern using up to 128 bits as a condition for activating a trigger. This allows you to set the CS signal that controls the interval for detecting the data source or the latch source that specifies the timing for comparing the pattern.

- **I<sup>2</sup>C**

This is a trigger function for capturing I<sup>2</sup>C bus signals. This function can be used on products with firmware version 1.60 or later. Triggers can be activated using five trigger modes.

I<sup>2</sup>C Bus is an abbreviation for Inter Integrated Circuit Bus. It is a bidirectional bus for connecting ICs. Note that the /F5 or /F8 option is required to analyze I<sup>2</sup>C bus signals.

- **CAN**

This is a trigger function for capturing CAN bus signals. This function can be used on products with firmware version 2.00 or later.

CAN stands for Controller Area Network. It is serial communication protocol standardized internationally by the ISO (International Organization for Standardization). Note that the /F7 or /F8 option is required to analyze CAN bus signals.

- **LIN**

This is a trigger function for capturing LIN bus signals. This function can be used on products with firmware version 2.40 or later.

LIN stands for Local Interconnect Network. It is serial communication protocol used mainly for automobiles and other vehicles. Note that the /F7 or /F8 option is required to analyze LIN bus signals.

- **SPI**

This is a trigger function for capturing SPI bus signals. This function can be used on products with firmware version 1.60 or later.

The SPI (Serial Peripheral Interface) Bus is a synchronized serial bus that is widely used for inter-IC communications and data communications. Note that the /F5, /F7, or /F8 option is required to analyze SPI bus signals.

**Event Interval**

Taking the trigger condition, excluding OR trigger and TV trigger, as an event, the trigger is activated when the event period, or the interval between two events meets preset time conditions. The time condition is the same as the time condition for the Width trigger.

• **Event Cycle**

When the event period is within the specified time range

**More than**

Determination time:  $T1$   
 $t1 < T1$   $t2 > T1$   $t3 < T1$

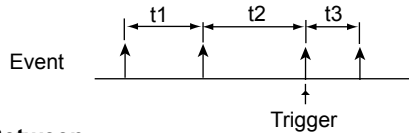

**Less than**

Determination time:  $T1$   
 $t1 < T1$   $t2 > T1$   $t3 < T1$

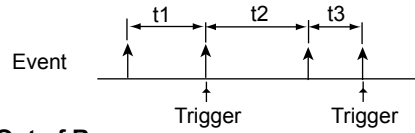

**Between**

Determination time:  $T1, T2$   
 $T1 < t1 < T2$   $T2 < t2$   $t3 < T1$

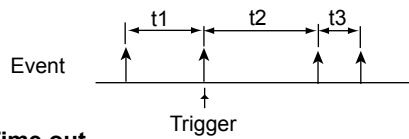

**Out of Range**

Determination time:  $T1, T2$   
 $T1 < t1 < T2$   $T2 < t2$   $t3 < T1$

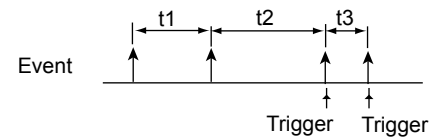

**Time out**

Determination time:  $T1$   
 $t1 < T1$   $t2 > T1$   $t3 < T1$

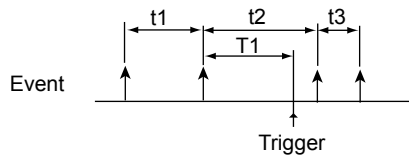

• **Event Delay**

When the time interval between event 1 occurring and the first occurrence of event 2 meets the specified time condition. If the condition is not met, the decision is restarted the next time event 1 is met.

The following shows More Than as an example.

**More than**

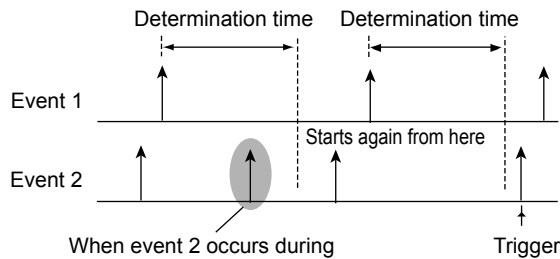

When event 2 occurs during the time interval, detection starts again from the next occurrence of event 1.

- **Event Sequence**

When the time interval between event 1 occurring and the first occurrence of event 2 meets the specified time condition. If the condition is not met, the DL9000 ignores event 2 that occurred and activates a trigger on event 2 that occurs while the specified time conditions are met.

The following shows More Than as an example.

**More than**

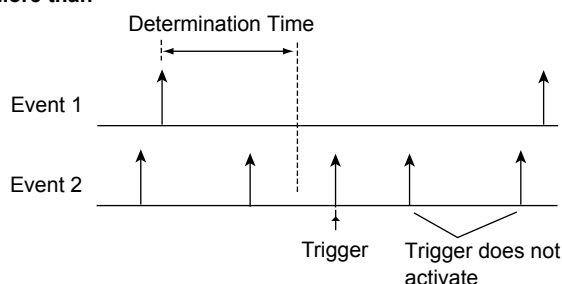

### Window Comparator <<For the procedure, see Section 6.3>>

This determines whether a trigger condition based on a waveform rising edge or falling edge, or High/Low, or a Qualify or State condition falls within (IN) or outside (OUT) a specified range (Window).

The Window comparator can be enabled or disabled for each channel separately. The trigger condition changes according to the Window comparator setting for the channel set for a trigger source and so on.

For example, if the source channel of an Edge trigger has the Window comparator enabled, the trigger can be activated according as the source channel waveform is within or outside the specified area.

### Trigger Mode <<For the procedure, see Section 6.1>>

Sets the conditions for updating the displayed waveforms. The following five trigger modes are available.

#### Auto Mode

If a trigger is not activated within a specified time (approximately 100 ms, referred to as the timeout time), the displayed waveforms are automatically updated.

#### Auto Level Mode

The displayed waveforms are updated in the same way as in auto mode.

In the case of an Edge trigger, if the trigger is not activated when the timeout time has elapsed, the amplitude of the trigger source is detected, and the trigger level is automatically updated to the center value of the amplitude.

#### Normal Mode

The displayed waveforms are updated only when the trigger condition holds. The displayed waveforms are not updated if a trigger does not occur.

### Single Mode

When the trigger condition holds, the displayed waveforms are updated once only, and waveform acquisition is stopped. This mode is useful when you are observing a single-shot signal.

### N single mode

For the specified number of times only, waveforms are acquired and stored in different memory areas each time the trigger condition holds, then acquisition stops and all acquired waveforms are displayed.

### Trigger Position <<For the procedure, see Section 6.6>>

When waveform acquisition starts, the trigger is activated by the set trigger condition, and the waveform captured to acquisition memory is displayed. When the trigger delay described in the next item is set to 0 s, the trigger position coincides with the point at which the trigger condition becomes true. By moving the trigger position on the screen, the display ratio of the waveform data ("pre-" data) before the trigger point which has been captured to acquisition memory (the pre-trigger part), and data ("post-" data) after the trigger point (the post-trigger part) can be changed.

### Trigger Delay <<For the procedure, see Section 6.5>>

Normally the waveform is displayed before and after the trigger point, but by when a trigger delay is set, the waveform can be captured and displayed after a certain delay from when the trigger is activated, either specified as a time or by a specified edge.

By time: Set a delay time after the trigger occurs. The delay is from 0 to 10 s.

First Edge after time: After the set time has elapse from the trigger occurring, delay until the specified edge is detected. The set time is from 0 to 10 s.

Edge Count: After the trigger occurs, delay until the specified edge has been detected a certain number of times.

### Trigger Coupling <<For the procedure, see Section 6.3>>

As with the input signals, the input coupling can be switched on trigger sources. Select the input coupling that is suitable for the trigger source signal.

The following two types of input coupling are available for the trigger source signal.

DC

Select this setting when using the source as is with no processing of the signal.

AC

Select this setting when using the signal with the DC components removed for the trigger source.

### HF Rejection <<For the procedure, see Section 6.3>>

Turn HF rejection ON to eliminate high frequency components above 15 kHz or 20 MHz from the trigger source. This prevents triggers from being activated at unexpected points due to the effect of high frequency noise.

**Trigger Hysteresis <<For the procedure, see Section 6.3>>**

If there is insufficient trigger level width and noise is present in the trigger source, the trigger point fluctuates each time a trigger is activated. This causes the displayed waveforms to be unstable. Again, even with a slope of the polarity opposite to that specified, noise near the threshold value can cause the trigger to be activated. To avoid such problems, a given margin (hysteresis) is added to the specified trigger level.

The DL9000 provides a selection between  $\nabla$  (narrow hysteresis) and  $\nabla$  (wide hysteresis). When  $\nabla$  is selected, the hysteresis is increased, and fluctuation in the trigger point due to noise can be reduced, giving a more stable waveform display. However, this setting can make the trigger point less precise, reducing the trigger sensitivity, so that a trigger source of low amplitude may fail to activate. With a stable waveform free of noise, or a low amplitude trigger signal, set the hysteresis to  $\nabla$ .

**Trigger Hold-off <<For the procedure, see Section 6.4>>**

The trigger hold-off function temporarily stops detection of the next trigger once a trigger has been activated. This function is useful when observing a pulse train signal, such as a PCM code or when using the history memory function described later (see page 2-19) and you want to change the waveform acquisition period.

## 2.5 Waveform Acquisition Conditions

### Acquisition Mode <<For the procedure, see Section 7.1>>

When storing sampled data in the acquisition memory (see “Signal Flow” in section 2.1), it is possible to perform processing on data and display waveforms based on the processed data. The following three types of data processing are available.

#### Normal Mode

In this mode, sampled data is stored in the acquisition memory without special processing.

#### Envelope Mode

In normal mode or averaging mode, the sample rate (the number of times data is acquired per second in the acquisition memory) drops if T/div is increased (see Appendix 1). However, in envelope mode, the maximum and minimum values are determined from the data sampled at 2.5 GS/s or 5 GS/s at time intervals one half that of the sampling period (inverse of the sample rate) of normal mode regardless of the interleave mode setting (ON or OFF). The maximum and minimum values are stored as pairs in the acquisition memory.

Envelope mode is useful when you want to avoid aliasing (see next page), since the sample rate remains high irrespective of the time axis setting. It is also useful when you want to detect glitches (narrow pulse signals) or display an envelope of a modulating signal.

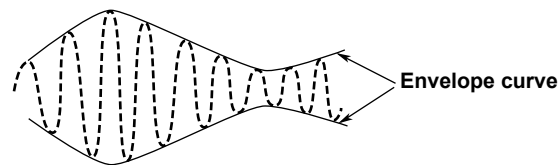

#### Averaging Mode

In the averaging mode, waveforms are acquired repeatedly to obtain the average of waveform data at the same time point (the same time in relation to the trigger point). The DL9000 takes the exponential or simple average of the waveform data and writes the results to the acquisition memory. The averaged data is then used to generate the display. When the trigger mode is auto mode, auto level mode, or normal mode then exponential averaging is used, and in the single mode, simple averaging. This mode is useful such as when eliminating random noise superimposed on the signal. The attenuation constant of exponential averaging can be set in the range of 2 to 1024 ( $2^n$  steps, where  $n$  is a positive integer). The average count of simple averaging can be set in the range of 2 to 65536 ( $2^n$  steps, where  $n$  is a positive integer).

#### Exponential averaging

(when trigger mode is set to auto, auto level, or normal)

$$A_n = \frac{1}{N} \{ (N-1)A_{n-1} + X_n \}$$

$A_n$ :  $n^{\text{th}}$  averaged value

$X_n$ :  $n^{\text{th}}$  measured value

$N$ : Attenuation constant (2 to 1024,  $2^n$  steps)

#### Simple average

(When trigger mode is set to single)

$$A_N = \frac{\sum_{n=1}^N X_n}{N}$$

$X_n$ :  $n^{\text{th}}$  measured value

$N$ : Average count

(acquisition count,  $2^n$  steps)

**High Resolution Mode <<For the procedure, see Section 7.2>>**

Normally, this unit takes digital values from the 8-bit A/D converter, applies specified processing, and then stores 8-bit values in primary memory.

On the other hand, the resolution of the A/D converter can be improved equivalently by placing a bandwidth limit on the input signal.

In high resolution mode, the effective number of bits per data value in the primary memory is expanded to 12 bits, and data is stored by maintaining the improved resolution through bandwidth limiting.

**Record Length <<For the procedure, see Section 7.3>>**

The term record length refers to the number of data points acquired per channel in the acquisition memory. The record lengths that can be set are: 2.5 k words (2500 points), 6.25 k words, 12.5 k words, 25 k words, 62.5 k words, 125 k words, 250 k words, 625 k words, 1.25 M words, 2.5 M words, and 6.25 M words (the maximum record length that can be set varies from model to model). Basically, if you change the time axis setting, the sample rate is changed to maintain the set record length at the same value. However, in some cases the record length is changed as a result, for example, of a changed time axis setting (see Appendix 1).

**Sampling Mode <<For the procedure, see Sections 7.4 to 7.6>>**

Depending on the time axis setting, you can switch the mode used to sample the input signal (sampling mode). The time axis ranges that allow the sampling mode to be changed vary depending on the acquisition mode and other settings. For details, see Appendix 1.

**Realtime sampling mode**

Changing the time axis setting causes the sample rate to change. Data can be sampled at up to 5 GS/s for the 701307/701308/701310/701311 (2.5 GS/s when interleave mode is OFF), and up to 10 GS/s for the 701312/701313 (5 GS/s when interleave mode is OFF). The input signal is sampled sequentially, and the data is stored in the acquisition memory.

In this mode, according to the sampling theorem\*, the waveform can only be correctly displayed up to a frequency which is one-half of the sample rate (samples per second, or S/s). Therefore, an appropriate sample rate for a waveform is such that the frequency of the waveform is comparatively lower.

\* If the sample rate is relatively low compared with the input signal frequency, then higher harmonic content of the signal will be lost. In this case, according to the Nyquist sampling theorem, the high frequency components may be transformed into low frequencies, by the process known as aliasing. acquisition By setting the mode to envelope waveform capture, aliasing can be avoided.

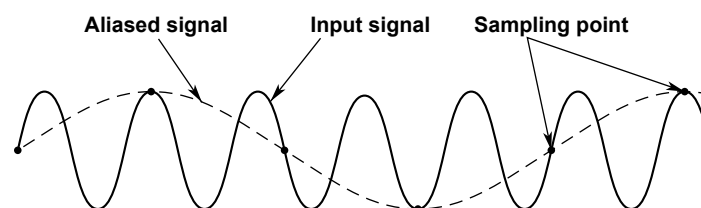



## 2.5 Waveform Acquisition Conditions

---

### Repetitive Sampling Mode

In the repetitive sampling mode, you can set a time axis that exceeds the maximum sample rate of 5 GS/s for the Model 701307/701308/701310/701311 (2.5 GS/s if the interleave mode is OFF), or 10 GS/s for the Model 701312/701313 (5 GS/s if the interleave mode is OFF). In this mode, one waveform is created from several cycles of a repetitive signal. This is equivalent to sampling the signal at a higher sample rate than the actual sample rate. The DL9000 enables an apparent maximum sample rate up to 2.5 TS/s.

If repetitive sampling mode is OFF and the sample rate exceeds the maximum selectable sample rate due to the relationship between the time axis and display record length, the display record length is reduced according to the time axis setting and sample rate.

There are two types of repetitive sampling. One is sequential sampling in which the data is sampled by intentionally offsetting the sampling points by a certain time with respect to the trigger point. The other is random sampling in which the data that is offset randomly from the trigger point is sampled and resorted with respect to the trigger point. The DL9000 employs random sampling which enables the waveform before the trigger point (trigger position, see Section 2.4) to be observed.

### Interleave Mode

A single input signal is sampled by two A/D converters, enabling the maximum sample rate to be increased, to a maximum 10 GS/s (5 GS/s for the 701307/701308/701310/701311) in realtime sampling mode.

For the relation between the interleave mode and time axis, record length, and sample rate, see Appendix 1.

### Interpolation

The practical sample rate can be increased up to 2.5 TS/s by interpolating the actual sampled data 1000 times (2000 times during high resolution mode).

## Action On Trigger <<For the procedure, see Section 7.8>>

Conditions can be determined at the zone through which the result of the automated measurement of waveform parameters or waveform passes. If the conditions are met, a given action can be executed at the same time as the waveform acquisition. The action to be carried out can be selected from a number of possibilities, including sounding an alarm, saving waveform data or a screen image, or printing a screen image, or sending E-mail.

The action on trigger operation is carried out with Exec on the menu screen. It cannot be carried out with the START/STOP key. Additionally, when the action on trigger is carried out, the trigger mode becomes the normal mode.

**GO/NO-GO Decision <<For the procedure, see Sections 7.9 to 7.16>>**

This is used as a criteria for the action-on-trigger. This function determines whether the acquired waveform meets the criteria (GO) or not (NO-GO). The function determines whether the waveform is within the preset range and performs a predetermined action when the decision is GO or NO-GO. There are eight methods of making the determination:

- Setting a waveform zone on the screen
- Setting a rectangular zone on the screen
- Setting a polygonal zone on the screen  
Creating a polygon on a computer with the supplied software.
- Setting the range of a waveform parameter
- Setting the range of a periodic statistics parameter
- Setting the range of an FFT parameter
- Setting the range of an XY waveform parameter
- Setting the range of a telecom test item

**History Memory <<For the procedure, see Chapter 11>>**

When waveforms are being measured, the waveform data stored in the acquisition memory as a result of a trigger being activated is displayed as waveforms on the DL9000 screen, and can be viewed. When triggers are successively activated and waveforms are acquired, it is impossible to stop the measurement in time when an abnormal waveform appears (newer waveforms appear on the screen). Normally, abnormal waveforms in the past cannot be displayed. However, by using the history memory function, the past waveform data (history waveforms including the current displayed waveform) stored in the acquisition memory can be displayed when waveform acquisition is stopped.

You can select the display mode from below.

- Display any single waveform
- Display all waveforms with a color or intensity gradation
- Display all waveforms with no gradation, highlighting a single specified waveform
- Displaying the simple arithmetic mean of all waveforms

You can also automatically replay from the oldest waveform to the newest waveform, and vice versa.

The number of waveforms N that can be acquired and held as history waveforms varies from 1 to 2000 depending on the record length setting, and model. If the number of waveforms N that can be acquired and held is exceeded, the oldest history waveform is cleared. The waveform currently displayed on the screen (newest waveform) is counted as the 1st waveform, and up to N-1 waveforms in the past can be displayed. The following figure indicates an example when N = 1000.

Holds waveform data of the last 1000 triggers

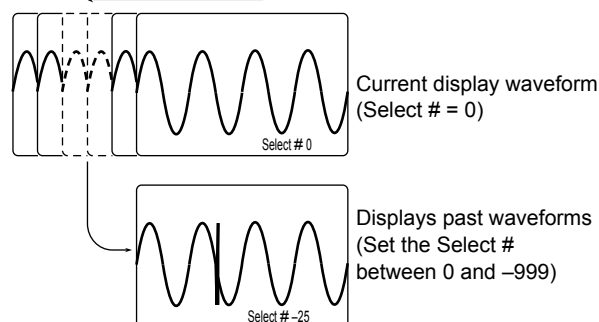

### History Search

When waveform acquisition is stopped, you can search for history waveforms that meet specified conditions.

#### **Zone Search <<For the procedure, see Sections 11.2, 11.3, and 11.5>>**

You can search for history waveforms that pass or do not pass a specified search zone. There are three types of search zone, as follows.

- **Waveform Zone**  
Set a zone on the screen using a waveform.
- **Rectangular zone**  
Set a rectangular zone on the screen.
- **Polygonal zone**  
Load a polygonal zone created on a computer.

#### **Waveform Parameter Search <<For the procedure, see Sections 11.4, 11.6, and 11.7>>**

From the history waveforms, you can search for waveform meeting or not meeting specified search parameter conditions. There are three types of search parameter, as follows.

- **Waveform Parameter**  
Search by values of the automated measurement of waveform parameters.
- **FFT Parameter**  
Search for FFT waveform marker measurement values, maximum values in a specified sector, or computation values using FFT measurement values.
- **XY Waveform Measurement Value**  
Search for a computation value using the area of an XY waveform or an area.

## 2.6 Display Conditions

### Display Format <<For the procedure, see Section 8.1>>

#### Splitting the Screen

The screen can be split evenly so that input waveforms and computed waveforms can be easily viewed. The screen can be divided in the following ways:

Single (no split), Dual (two ways), Triad (three ways), Quad (four ways)

#### Waveform Assignment

You can assign channels to the divided windows.

- **Auto**

Waveforms whose display is turned ON are assigned in order from the top.

- **Manual**

Regardless of whether the display is ON or OFF, waveforms can be assigned freely to each window.

### Display Interpolation <<For the procedure, see Section 8.2>>

If a given size of data is not available in 10 divisions along the time axis, the data can be interpolated to display the waveform.

#### Sine Interpolation

Interpolated data is created with the function  $(\sin x)/x$ , to interpolate between two points with a sine wave. Sine interpolation is suitable for observing sine waves or similar waves.

#### Linear Interpolation

Linearly interpolates between two points.

#### Pulse Interpolation

Interpolates between two points in a step pattern.

#### Interpolation OFF

Displays discrete dots without performing interpolation.

### Accumulated Display <<For the procedure, see Section 7.7>>

The display time of old waveforms can be set longer than the waveform update period, so that newer waveforms are superimposed (accumulated) on older waveforms. There are two modes, as follows:

- **Count**

The specified number of waveforms are superimposed. A gradation is applied according to the data frequency.

- **Time**

Waveforms for the specified time are superimposed. A gradation is applied from older data to new.

For each of these modes, there are two types of display, as follows:

- **Inten**

Display using different intensity levels.

- **Color**

Display with a color gradation.

The accumulated display is useful when observing noise, jitter, and transient phenomena in waveforms. The accumulated waveforms can also be saved.

**Waveform Zooming <<For the procedure, see Section 10.4>>**

Displayed waveforms can be enlarged in both the time axis and the voltage axis directions. This function is useful when the waveform acquisition time is set long and you wish to observe a particular section of the waveform closely. The zoom position can be set in grid div units.

The zoom waveform can be displayed at up to two positions simultaneously (dual zoom). The display combinations of the normal waveform, zoom waveform, and analysis screen windows are as follows, with the normal waveform area identified as Main, the zoom waveform areas as Z1 and Z2, and the analysis areas as A1 and A2.

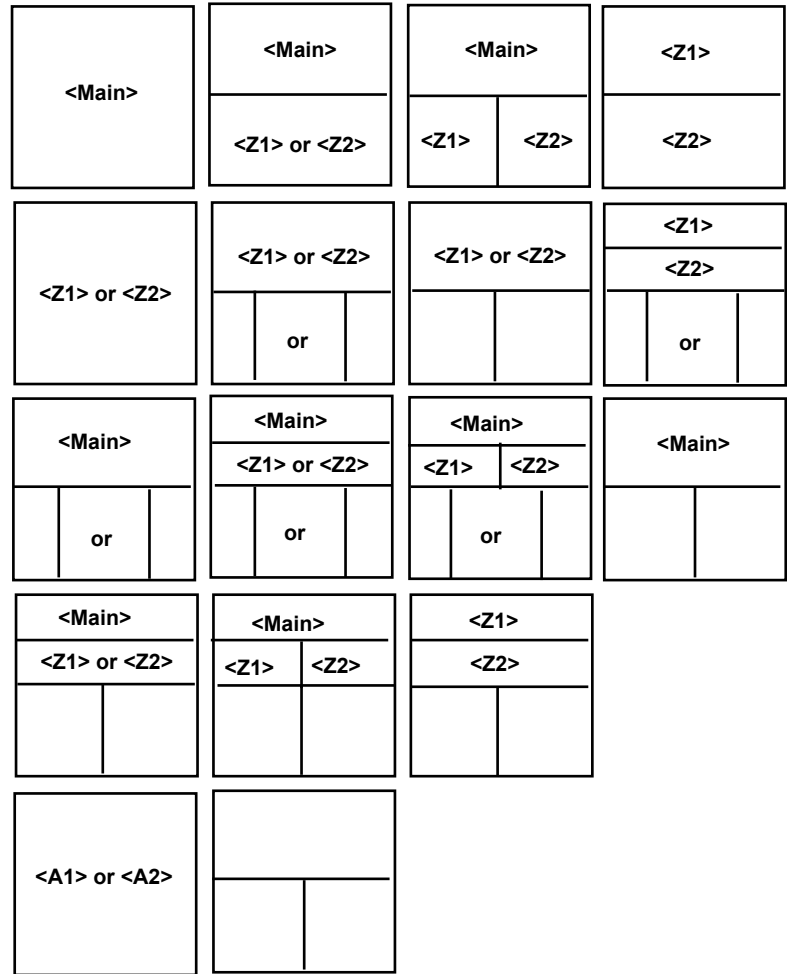

When the Main (normal waveform) and Zoom 1 or Zoom 2 waveforms are displayed simultaneously, a zoom box appears in the normal waveform area to indicate the zoom position. The center of the zoom is the center of this box. For details of display examples, see Section 1.3, "Screen Displaying Zoom Waveforms."

You can select the display format of the zoom waveform area, and whether a trace is on or off, independently of the Main waveform area.

When zooming in the voltage axis direction, you can select a waveform to enlarge, and set it to 1.05 to 10 times normal size.

When zooming in the time axis direction, you can enlarge until there are ten data points in the zoom waveform area.

You can also set a point meeting a set trigger condition as the zoom center, or automatically move the zoom center.

**Snapshot and Snap Clear <<For the procedure, see Section 8.6>>**

By using the snapshot function, you can temporarily hold the waveform (snapshot waveform) that would be cleared when the screen is updated on the screen. The snapshot waveform is displayed in white, allowing for easy comparison against the updated waveform. The snapshot waveform can be printed as screen image data, but cannot be used for cursor measurement, automated measurement of waveform parameters, zoom, and computation functions.

**Snap Clear**

Press the SHIFT key, then press the SNAP SHOT key, to clear the snapshot waveform.

**Scale Value Display <<For the procedure, see Section 5.12>>**

The upper and lower limits (scale values) of the vertical and horizontal axes of each waveform can be displayed.

**Displaying Waveform Labels <<For the procedure, see Section 8.5>>**

A waveform label of up to eight characters can be assigned to each waveform and displayed.

---

## 2.7 Waveform Computation

### **Prescaling and Rescaling <<For the procedure, see Chapter 9>>**

Prescaling linearly scales the source waveform before carrying out computation. The computation uses the scaled values.

Rescaling linearly scales the results of the computation.

### **Computed Waveform Display**

By setting a computation equation for each of CH1 to CH4, and M1 to M4, a maximum of eight computed waveforms can be displayed.

### **Through (Linear Scaling) <<For the procedure, see Section 9.1>>**

By setting Through, linear scaling only can be carried out.

### **Addition, Subtraction, and Multiplication <<For the procedure, see Section 9.2>>**

Addition, subtraction, and multiplication can be applied to any of CH1 to CH4, using the input waveform of the channel itself together with the waveform of any of CH1 to CH4 and REF1 to REF4 as operands, and can be applied to M1 to M4, using any two waveforms of CH1 to CH4 and REF1 to REF4 as operands. The computation result is used as the waveform (computed waveform) for CH1 to CH4 or M1 to M4.

The addition (+) and subtraction (–) functions are convenient for comparison with a reference signal, checking signal logic, or phase comparison, and multiplication (×) can be used to check the power waveform when inputting a voltage signal and current signal.

### **Integration <<For the procedure, see Section 9.3>>**

This integrates the selected waveform. Taking the specified integration start point as 0, the entire region is calculated, counting up toward the newest data, and counting down toward the oldest data. For CH1 to CH4 the computation applies to the input waveform of the channel itself, and for M1 to M4 applies to any of CH1 to CH4 and REF1 to REF4.

### **Phase Shift <<For the procedure, see Section 9.4>>**

A waveform can be displayed phase-shifted. To advance the phase, set a positive value, and to delay the phase, set a negative value.

### **Filter <<For the procedure, see Section 9.5>>**

High-frequency noise can be filtered out (with a low-pass filter), or low-frequency noise can be filtered out (with a high-pass filter).

You can select a first-order filter or a second-order filter. When a second-order filter is selected, there is no phase delay.

### **Smoothing <<For the procedure, see Section 9.6>>**

A waveform can be displayed smoothed, by removing noise with a sliding average.

**Edge Count <<For the procedure, see Section 9.7>>**

This counts edges of a selected waveform. This function can be used on products with firmware version 1.60 or later. Taking the specified integration start point as 0, the entire region is calculated, counting up toward the newest data, and counting down toward the oldest data. For CH1 to CH4 the computation applies to the input waveform of the channel itself, and for M1 to M4 applies to any of CH1 to CH4 and REF1 to REF4.

**Rotary Count <<For the procedure, see Section 9.8>>**

Phase changes between phase A (Source 1) and phase B (Source 2) are counted up or down, taking a rise above a specified level as 1, and a fall below the level as 0. This function can be used on products with firmware version 1.60 or later. Taking the specified integration start point as 0, the entire region is calculated, counting up toward the newest data, and counting down toward the oldest data. For CH1 to CH4 the computation applies to the input waveform of the channel itself, and for M1 to M4 applies to any of CH1 to CH4 and REF1 to REF4.

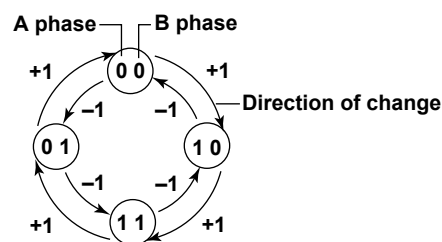
**Scale Conversion of a Computed Waveform (Ranging) <<For the procedure, see Chapter 9>>**

When displaying a computed waveform, normally auto scaling is carried out, but manual scaling can also be selected.

Auto scaling automatically determines from the computed waveform the center line level<sup>\*1</sup> (Center) in the vertical axis direction of the screen area and the sensitivity<sup>\*2</sup> (Sensitivity), to display the computed waveform.

Manual scaling allows both Center and Sensitivity to be set as required.

\*1 For a voltage waveform this is a voltage value.

\*2 For a voltage waveform, this is a voltage value per 1 div.

**User Defined Math (Option) <<For the procedure, see section 9.9>>**

Available for the DL9000 with the /G4 or /G2 option.

You can define equations arbitrarily by combining the following functions.

**Operator**

+, -, \*, /, ABS (absolute value), SQRT (square root), LOG, LN (natural logarithm), EXP (exponents), - (inverse), P2 (squares), DELAY (phase shift), BIN (binary), SIN (sine), ASIN (arcsine), COS (cosine), TAN (tangent), ATAN (arctangent), DIFF (differential), INTEG (integral),

**Constant**

Napier's constant (e), PI ( $\pi$ ), sample rate (fs), Exp (exponent display), waveform parameters (measure item), constants (K1-K4)

**Waveform**

CH1 to CH4, REF1 to REF4



---

## 2.8 Analyzing and Searching Waveforms

### Cursor Measurements <<For the procedure, see Section 10.1>>

Cursors can be placed on the displayed waveform from waveform data held in acquisition memory (within the range of the display record length - see Appendix 1), and various measurement values at the intersection of the cursor and waveform can be displayed. There are six types of cursor.

#### Horizontal Cursors

Two broken lines (horizontal cursors) are displayed parallel to the horizontal axis, and the Y-axis values at the cursor positions can be measured. The level difference between cursors can also be measured.

A computation formula using the cursor measurement values can also be set, and the result displayed.

#### Vertical Cursors

Two broken lines (vertical cursors) are displayed parallel to the vertical axis, and the times from the trigger position to each vertical cursor, the time difference between the vertical cursors, and the reciprocal of the time difference can be measured.

A computation formula using the cursor measurement values can also be set, and the result displayed.

#### H&V cursors

The horizontal cursors and vertical cursors are displayed simultaneously.

#### VT cursor

A broken line (VT cursor) is displayed on the vertical axis, and the time from the trigger position to the VT cursor, and the VT cursor position measurement value are displayed.

A computation formula using the cursor measurement values can also be set, and the result displayed.

#### Marker Cursors

Four markers are displayed on the selected waveform. The level at each marker, the time from the trigger position, and the level difference and time difference between markers can be measured.

A computation formula using the marker measurement values can also be set, and the result displayed.

#### Serial cursor

A broken line (serial cursor) is displayed on the vertical axis, showing a two-valued function of the waveform from the cursor position, according to the bitrate, bit length, and threshold settings.

## Automated Measurement of Waveform Parameters

**Automated Measurement of Waveform Parameters** <<For the procedure, see Section 10.2>>

Automated measurement can be performed on various measurement parameters of the displayed waveform stored in the acquisition memory.

Up to a maximum of 100,000 automatic measurement results can be saved in a file.

There are 27 different measurement items. A maximum of 16 items can be displayed from the selected items for all channels together. A computation formula using the automatic measurement values can also be set, and the result displayed.

**Statistical Processing** <<For the procedure, see Section 10.3>>

Statistical processing can be performed on the automated measurement values described above. The following five statistics can be determined on the two measured values of automated measurement parameters.

- Maximum value (Max)
- Minimum value (Min)
- Mean value (Mean)
- Standard deviation ( $\sigma$ )
- Count of measurement values subjected to statistics processing (Cnt)

The following three statistical processing methods are available.

- **Normal Statistical Processing**

Statistical processing is carried out while acquiring waveforms, on the specified number of waveforms from the most recently captured. If waveform acquisition is stopped, then restarted, the statistical processing from before stopping is continued. Carrying out a Restart in the menus resets the statistical processing up to that point. It is also possible to set the number of data values used in statistical processing.

- **Statistical Processing Over One Cycle of Measurement or Within Measurement Range**

In the displayed waveforms, the period is found sequentially from the oldest data, and data within that period is used for measurement of the selected automatic measurement item, then statistical processing is carried out. The method of finding the period is the same as for Period in the normal waveform parameters.

- **Statistical Processing of History Waveforms**

Automated measurement is performed on the history waveforms in the selected range and statistical processing is performed. The statistical processing is carried out from the oldest waveforms first.

**Telecom Test <<For the procedure, see Section 10.7>>**

There are two tests used in analysis of telecommunications signals: the mask test, and the test for automatic measurement of waveform parameters for the eye pattern test. The automated measurement of waveform parameters of eye patterns can be used on products with firmware version 1.60 or later.

Measurement is performed on the accumulated waveform when the mode is set to Count. In the mask test, a mask pattern created with the software supplied free of charge by Yokogawa is read into the DL9000, and the waveforms passing through the mask are counted.

In the eye pattern test, the following items are measured in the eye pattern.

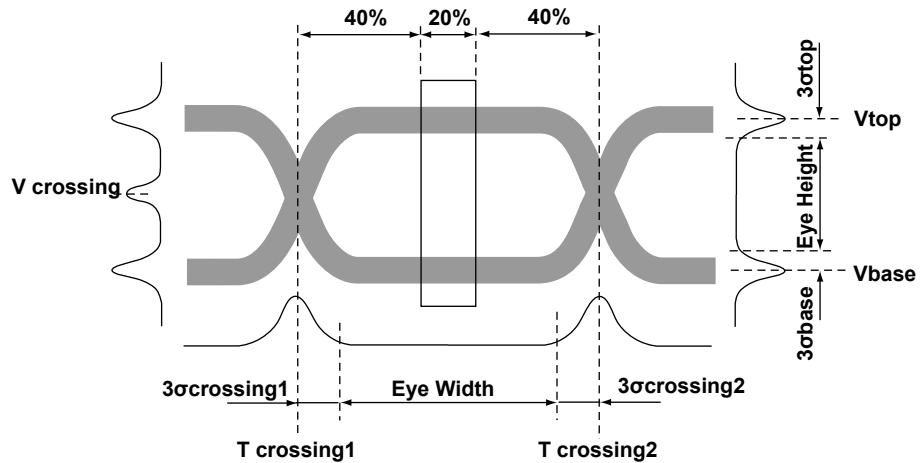

Vtop	Vertical histogram top peak average voltage.
Vbase	Vertical histogram bottom peak average voltage.
σ top	Vertical histogram top peak standard deviation.
σ base	Vertical histogram bottom peak standard deviation.
Tcrossing1	First crossing point average time value.
Tcrossing2	Second crossing point average time value.
Vcrossing	Voltage at the point of intersection of the rising edge and falling edge.
Crossing %	Level of the point of intersection of the rising edge and falling edge of the eye pattern as a proportion of the difference between Vtop and Vbase.
Eye Height	Height of the opening in the eye diagram.
Eye Width	Width of the opening in the eye diagram.
Q Factor	Quality factor for the eye diagram showing the height of the eye pattern opening, with respect to the noise at both high and low voltage levels.
Jitter	Magnitude of the fluctuation in the time position of the crossing point.
Duty Cycle Distortion %	The percentage of full bit width of time difference between the intermediate point of the falling edge and the intermediate point of the rising edge at the intermediate threshold value.
Ext Rate dB	Extinction rate dB.
Rise	Rise time from the specified lower to upper threshold level.
Fall	Fall time from the specified upper to lower threshold level.

The following formulas are used to calculate each item.

$$\text{Crossing\%} = 100 \frac{V_{\text{crossing}} - V_{\text{base}}}{V_{\text{top}} - V_{\text{base}}}$$

$$\text{Duty Cycle Distortion\%} = 100 \frac{|T_{\text{rising50\%}} - T_{\text{falling50\%}}|}{T_{\text{crossing2}} - T_{\text{crossing1}}}$$

$$\text{EyeHeight} = (V_{\text{top}} - 3\sigma_{\text{top}}) - (V_{\text{base}} + 3\sigma_{\text{base}})$$

$$\text{EyeWidth} = (T_{\text{crossing2}} - 3\sigma_{\text{crossing2}}) - (T_{\text{crossing1}} + 3\sigma_{\text{crossing1}})$$

$$\text{Jitter} = \sigma_{\text{crossing1}}$$

$$\text{QFactor} = \frac{V_{\text{top}} - V_{\text{base}}}{\sigma_{\text{top}} + \sigma_{\text{base}}}$$

$$\text{ExtRatedB} = 10 \log \left( \frac{V_{\text{top}} - V_{\text{dark}}}{V_{\text{base}} - V_{\text{dark}}} \right)$$

### X-Y Analysis <<For the procedure, see Section 10.8>>









With one waveform level applied to the X-axis (horizontal axis), and a second waveform level applied to the Y-axis (vertical axis), the phase relationship between the two input signals can be observed. Simultaneous observation of X-Y waveforms and normal T-Y waveforms (waveform display using time axis and level) is possible.

It is also possible to specify the ranges for X-Y analysis, or carry out analysis depending on the specified waveform level.

The X-Y analysis results can be used for cursor measurement, and also the area can be computed. For details of the computation of area, see Appendix 2, "Waveform Area Computation."

You can use the X-Y waveform display function to measure the phase angle between two sine wave signals. For example, an X-Y display of two sine waves produces a so-called Lissajous figure, from which the phase angle can be read.

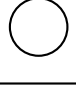
Lissajous waveform

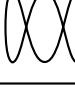
Phase angle 0°			
Phase angle 45°			
Phase angle 90°			
Frequency ratio (X : Y)	1 : 1	1 : 2	1 : 3

**FFT Analysis <<For the procedure, see Section 10.9>>**

This executes a Fast Fourier Transform (FFT), and displays the power spectrum.

You can select the trace for the real part or the trace for the imaginary part. If the trace for the imaginary part is not set, the real part only is used for calculation, and negative frequencies are not displayed.

You can select the time window from Rectangular, Hanning, and Flattop.

The rectangular window is best suited to transient signals, such as impulse waves, which attenuate completely within the time window. The Hanning and flattop windows allow continuity of the signal by gradually attenuating the parts of the signal located near the ends of the time window down to the zero level. Hence, it is best suited to continuous signals. With the Hanning window, the frequency resolution is high compared to the flattop window. However, the flattop window has a higher spectral level accuracy. When the waveform being analyzed is a continuous signal, select the whichever of the Hanning window and flattop window is more suitable for the application.

The number of points in the FFT can be selected from 2.5 k, 6.25 k, 12.5 k, 25 k, 62.5 k, 125 k, and 250 k. The FFT range is specified in the waveform area (Main/Zoom 1/Zoom 2). If the waveform area record length is more than the number of FFT points, the data is downsampled for computation.

Marker measurement or peak value measurement can be used on the FFT waveform.

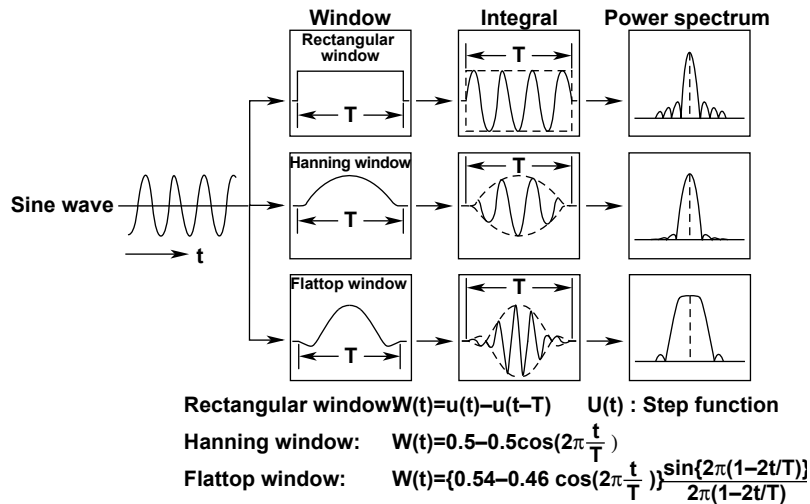

**FFT Function**

Given that the complex function resulting after the FFT is  $G = R + jI$ , the power spectrum can be expressed as follows:

<b>DC component</b>	<b>AC component</b>
$10 \log(R^2 + I^2)$	$10 \log\left(\frac{R^2 + I^2}{2}\right)$

R: Real Part, I: Imaginary Part

Reference value (0 dB) of the logarithmic magnitude (Log mag): 1 Vrms<sup>2</sup>

**Waveform Parameter Histogram, Trend and List Displays <<For the procedure, see Section 10.10>>**

You can display a selected waveform parameter as a histogram or trend. In the histogram display, the average value, standard deviation, peak value, and distributed integration value of a waveform parameter can be measured. In the trend display, time series changes in the waveform parameter can be observed, and a cursor displayed to measure the level.

Results of automated measurement of waveform parameters can be displayed in a list.

**Accumulated Histogram Display <<For the procedure, see Section 10.11>>**

For a repeatedly captured waveform, a frequency distribution histogram (Vertical, Horizontal) is shown for the specified region. On the histogram, the average value, standard deviation, maximum value, minimum value, peak value, intermediate value, and distributed integration value can be measured, and with the cursors, X-axis values or times can be measured. Using these measurement values, further calculation can be carried out.

This is useful for measuring jitter.

## 2.9 Communications

### Command-Based Communications (USB/Ethernet) <<For the procedure, refer to the CD Communications Interface User's Manual>>

A USB interface is provided as standard equipment, and an Ethernet interface is available as an option. Using communication commands, you can output waveform data to a computer for data analysis or control the DL9000 using an external controller to carry out waveform measurements.

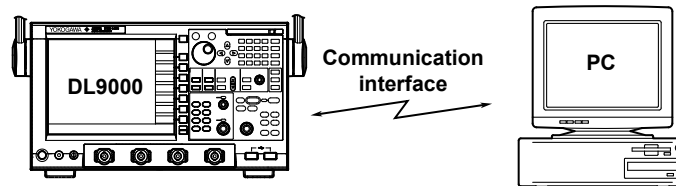

### Saving and Recalling Data on a Network Drive <<For the procedure, see Section 15.3>>

In the same way as on the internal storage media, waveform and setting data can be saved to or recalled from a computer on the network, and screen image data can also be saved.

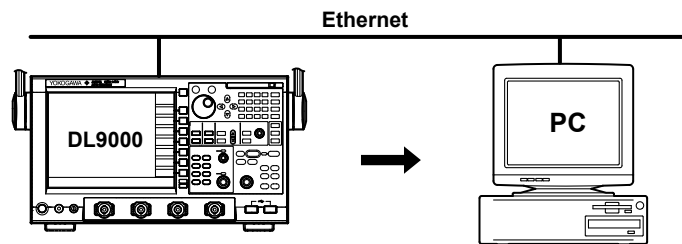

### Accessing the DL9000 from a Computer <<For the procedure, see Section 15.6, 15.7>>

By accessing the DL9000 from a computer on the network, you can extract files from the DL9000 internal storage media.

Also, you can display the instrument's screen on a PC for monitoring (Web server function).

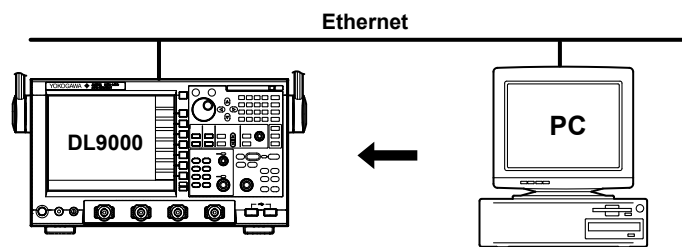

## 2.10 Other Useful Functions

### Entering Numeric and Text Data from a USB Keyboard <<For the procedure, see Section 4.3>>

A USB keyboard can be connected, and used for entering file names and comments. Since the functions of the keys on the DL9000 front panel are also assigned to keys on the keyboard, the keyboard can be used in the same way as the keys on the DL9000 itself.

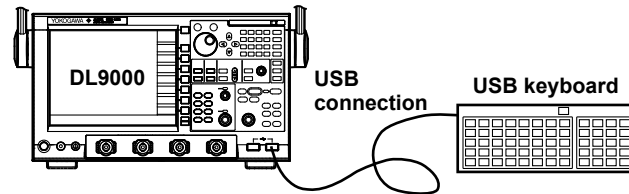

### Operating the DL9000 Using a USB Mouse <<For the procedure, see Section 4.3>>

You can use a USB mouse to operate the DL9000 as you would using the front panel keys. In addition, you can point to a desired item on a menu and click the item. This is analogous to pressing a soft key corresponding to a menu and pressing the SET key.

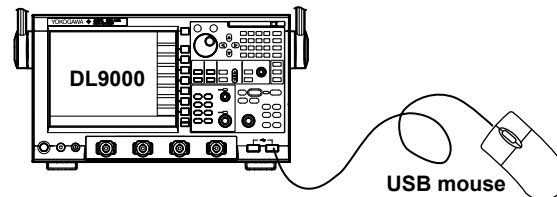

### Initialization <<For the procedure, see Section 4.4>>

You can return all settings to their default values. However, some of the settings are not initialized (see Section 4.4). To initialize all settings excluding the date/time setting (display ON/OFF is initialized) to their factory defaults, turn ON the power while holding down the RESET key. Release the RESET key after a beep sounds.

### Auto Setup <<For the procedure, see Section 4.5>>

This function automatically sets the voltage axis, time axis, trigger settings, and other settings to suit the input signal. This is useful when the characteristics of the input signal are unknown. However, the auto setup function may not work depending on the input signal.

### Screen Image Printing <<For the procedure, see Chapter 12 and Section 15.8>>

Screen images can be printed on the built-in printer (option), USB printer, or network printer (when the Ethernet interface option is installed).



**Saving and Loading Data from a Storage Medium <<For the procedure, see Chapter 13>>**

The DL9000 allows various data to be stored to and loaded from the following storage media.

- PC card (standard equipment)
- External USB device (MO disk drive/hard disk drive etc.)
- Network drive (when the Ethernet interface option is installed)

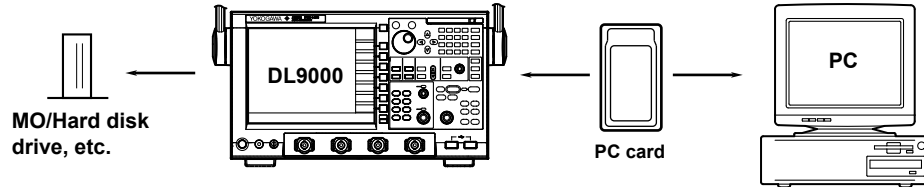

**Saving and Loading Setting Data, Waveform Data, and Waveforms <<For the procedure, see Sections 13.4 and 13.5>>**

Setup data, waveform data, and snapshot waveforms can be saved to or loaded from a selected storage medium.

**Saving Screen Image Data <<For the procedure, see Section 13.8>>**

Screen image data can be stored to a selected storage medium. The formats that can be saved are BMP, PNG, and JPEG and these can be used to incorporate the screen image data in a document using DTP software.

**Saving Values from Automated Measurement of Waveform Parameters, Accum Histogram, and FFT waveforms <<For the procedure, see Section 13.9>>**

The values from automated measurement of waveform parameters, accum histogram, and FFT waveforms can be saved to a selected storage medium.

## 3.1 Handling Precautions

### Safety Precautions

If you are using this instrument for the first time, make sure to thoroughly read the safety precautions given on pages v and vi.

#### **Do Not Remove the Case**

Do not remove the case from the instrument. Some sections inside the instrument have high voltages and are extremely dangerous. For internal inspections or adjustments, contact your dealer.

#### **Unplug If Abnormal Behavior Occurs**

If you notice smoke or unusual odors coming from the instrument, immediately turn OFF the power and unplug the power cord. If such an irregularity occurs, contact your dealer.

#### **Do Not Damage the Power Cord**

Nothing should be placed on the power cord. The cord should be kept away from any heat sources. When unplugging the power cord from the outlet, never pull by the cord itself. Always hold and pull by the plug. If the power cord is damaged, contact your dealer for replacement. Refer to page iii for the part number when placing an order.

### General Handling Precautions

#### **Do Not Place Objects on Top of the Instrument**

Never place other instruments or objects containing water on top of the instrument, otherwise a breakdown may occur.

#### **Do Not Apply Shock to the Input Section**

Shocks to the input connectors or probes may turn into electrical noise and enter the instrument via the signal lines.

#### **Do Not Damage the LCD**

Since the LCD screen is very vulnerable and can be easily scratched, do not allow any sharp objects near it. Also it should not be exposed to vibrations and shocks.

#### **Unplug during Extended Non-Use**

Unplug the power cord from the outlet.

#### When Carrying the Instrument

Remove the power cord and connecting cables. Use the handles to lift and carry the instrument.

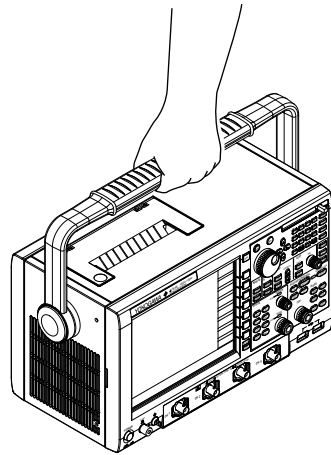

#### Using the handle

---

#### CAUTION

- Do not apply unreasonable force to the handle. This could break the handle.
  - When turning the handle, take care not to turn the handle attachment (the blue cover) at the same time, as doing so could damage the handle attachment. The handle attachment can turn at the same time when unlocking the handle if pushed forcefully, or after unlocking the handle when turning the handle while pressing the attachment.
- 

The instrument's handle is attached at locations 1 and 2 in the figure below. When changing the position of the handle, press the left and right attachment (the blue cover) and release the lock as in the figure below before moving the handle. When doing so, take care not to turn the handle attachment (the blue cover) at the same time. Turn the handle until it clicks into place.

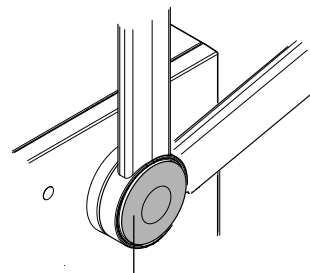
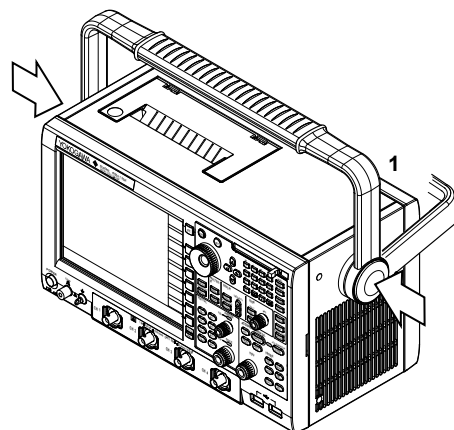

If you turn the handle slightly while pressing this part (the handle attachment), the lock releases. When turning the handle after releasing the lock, make sure not to turn this part.

#### Cleaning

When cleaning the case or the operation panel, first remove the power cord from the AC outlet. Then, wipe with a dry, soft, clean cloth. Do not use chemical such as benzene or thinner. These can cause discoloring and deformation.

## 3.2 Installing the Instrument

### Installation Conditions

Install the instrument in a place that meets the following conditions.

#### Flat, Even Surface

Install the instrument with the correct orientation on a stable, horizontal surface. The recording quality of the printer may be hindered when the instrument is placed in an unstable or inclined place.

#### Well-Ventilated Location

Inlet holes are located on the top and bottom of the instrument. There are also exhaust holes on the right side. To prevent internal overheating, allow for enough space around the instrument (see the figure below) and do not block the inlet and exhaust holes.

### CAUTION

If the inlets on the left and bottom side of the instrument, and exhaust holes on the right side are blocked, the temperature of the instrument will rise, and can result in damage.

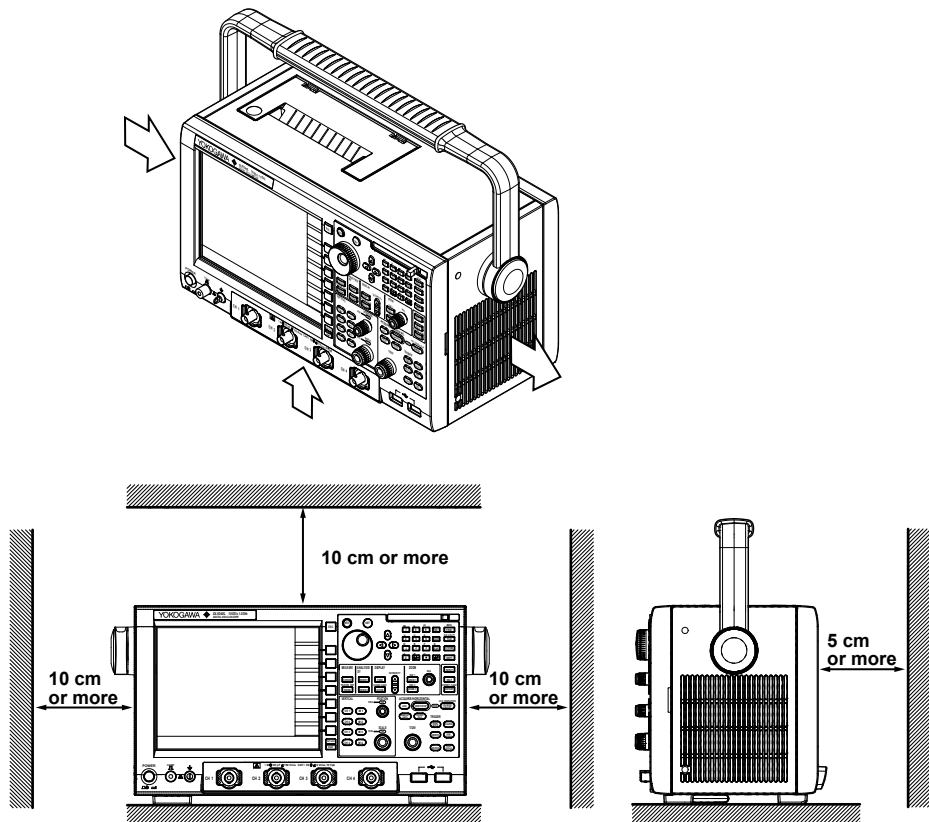

Including the spaces shown in the drawing above, allow for plenty of space to connect the cables and to open and close the cover of the built-in printer.

### 3.2 Installing the Instrument

#### Ambient Temperature and Humidity

Ambient temperature	5 - 40°C
Ambient humidity	20 to 80% RH when the printer is not used. (No condensation) 35 to 80% RH when using the printer. (No condensation)

#### Note

- To ensure high measurement accuracy, operate the instrument in the 23 ±5°C temperature range and 55 ±10% RH.
- Condensation may occur if the instrument is moved to another place where the ambient temperature is higher, or if the temperature changes rapidly. In such cases, allow the instrument adjust to the new environment for at least an hour before using the instrument.

#### Do not install the instrument in the following places.

- In direct sunlight or near heat sources.
- Where an excessive amount of soot, steam, dust, or corrosive gas is present.
- Near strong magnetic field sources.
- Near high voltage equipment or power lines.
- Where the level of mechanical vibration is high.
- On an unstable surface.

#### Installation position

Place the instrument in a horizontal position or inclined position using the stand or the handles (see the figure below). When using the stand, pull it forward until it locks. To retract it, set the stand back to its original position. Do not install the DL9000 in a position other than those indicated below.

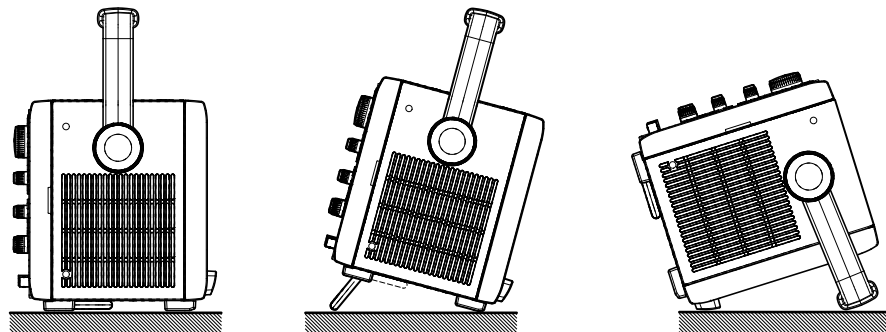

#### Rubber Feet

You can attach anti-slip rubber pads to the four feet on the bottom of the instrument, and the two projections on the rear. Six rubber pads are included with the DL9000.

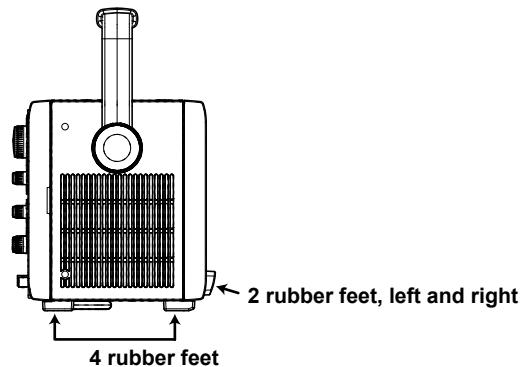

## 3.3 Connecting the Power

### Before Connecting the Power

Make sure that you observe the following points before connecting the power. Failure to do so may cause electric shock or damage to the instrument.



#### WARNING

- Before connecting the power cord, ensure that the source voltage matches the rated supply voltage of the instrument and that it is within the maximum rated voltage of the provided power cord.
- Check that both the main power switch and power switch of the DL9000 are off before connection the power cord.
- To prevent the possibility of electric shock or fire, be sure to use the power cord for the instrument that was supplied by YOKOGAWA.
- Make sure to perform protective earth grounding to prevent electric shock. Connect the power cord to a three-prong power outlet with a protective earth terminal.
- Do not use an extension cord without a protective earth ground. Otherwise, the protection function will be compromised.
- If an AC outlet that conforms to the accessory power cord is unavailable and protective grounding cannot be furnished, do not use the instrument.

### Connecting the Power Cord

1. Check that both the main power switch and power switch of the DL9000 are off.
2. Connect the power cord plug to the power connector on the rear panel.
3. Connect the other end of the cord to an outlet that meets the conditions below.  
Use the three-prong power outlet equipped with a protective earth terminal.

#### Item

Rated supply voltage*	100 to 120 VAC/220 to 240 VAC (automatic switching)
Permitted supply voltage range	90 to 132 VAC/198 to 264 VAC
Rated supply voltage frequency	50/60 Hz
Permitted supply voltage frequency range	48 to 63 Hz
Maximum power consumption	Max. approx. 300 VA

\* The DL9000 can use a 100-V or a 200-V system for the power supply. The maximum rated voltage differs according to the type of power cord. Check that the voltage supplied to the DL9000 is less than or equal to the maximum rated voltage of the provided power cord (see page ii) before using it.

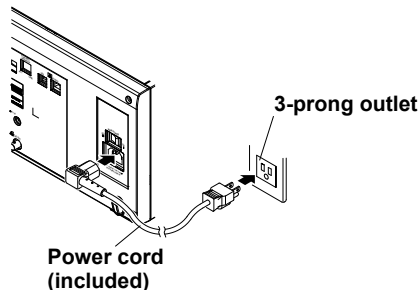

#### Turning ON the Power Switch

##### Items to Be Checked before Turning ON the Power

- The instrument is properly installed.: “3.2 Installing the Instrument”
- The power cord is properly connected.: Previous page

##### Turning ON the Main Power Switch

1. Switch the rear panel power switch to the ON ( | ) position.

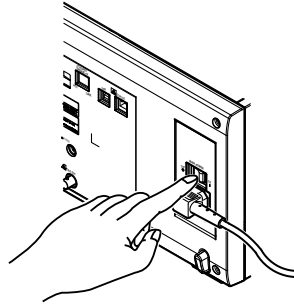

##### Turning ON the Power Switch

2. Press the power switch on the front panel.

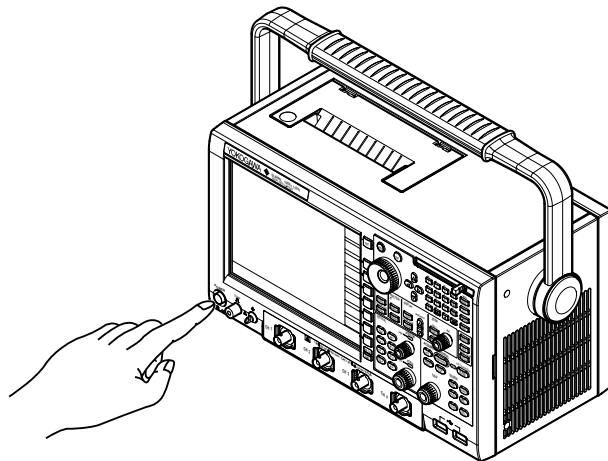

#### Powering off

---

#### CAUTION

---

Abruptly turning the main power switch off or unplugging the power cord while saving data or printing with the built-in printer, may damage the built-in printer or corrupt the media (PC card, internal hard disk, USB storage, and so on) on which data is being saved. The data being saved is also not guaranteed. Always complete data saving before turning off the main power switch.

---

##### Turning the Power Switch OFF

1. Press the power switch on the front panel.

##### Turning the Main Power Switch OFF

2. Check that the DL9000 internal fan has stopped, and that the screen is blank, then switch the power switch on the rear panel to the OFF ( | ) position.

## Power Up Operation

A self-test and calibration start automatically when the power switch is turned ON. That lasts approximately 30 seconds. If the check results are satisfactory, the normal waveform display screen will appear.

### **Note**

- Allow at least 10 seconds before turning ON the power switch after turning it OFF.
- If self-test and calibration do not start when the power is turned ON, or if the normal waveform display screen does not appear, turn OFF the power switch and check the following points.
  - That the power cord is plugged in properly.
  - That the correct voltage is coming to the power outlet (see page 3-5).
  - The settings are initialized (they are returned to factory default settings) by turning on the power switch while holding down the RESET key. For details on the initialization of the settings, see section 4.4, "Initializing Settings."

If the instrument still fails to power up when the power switch is turned ON after checking these points, contact your dealer.

- It takes several seconds for the startup screen to appear.

## For Taking Accurate Measurements

- To ensure accurate measurements, allow the instrument to warm up for at least 30 minutes after turning ON the power switch.
- After warm-up is complete, perform calibration (see section 4.8). If Auto Calibration is on, it will be executed automatically when T/div is changed and waveform acquisition is started.

## Power Down Operation

The settings just prior to turning OFF the power (or when the power cord is unplugged) are stored. Therefore, the next time the power is turned ON, waveforms are measured using those settings.

### **Note**

- A built-in lithium battery powers the memory that stores the settings. It has a life-span of approximately 5 years when kept at an ambient temperature of 23°C. When the lithium battery voltage falls below a certain level, a message is displayed on the screen (error 900) when the power switch is turned ON. Whenever you see this message, you must have the lithium battery replaced immediately. The user cannot replace the battery. Contact your dealer to have a new battery installed.
- If you turn OFF the main power switch of the rear panel when the power switch of the front panel is ON, the settings immediately before the power is turned OFF may not be stored correctly. An error message (error 900) may appear on the screen the next time you turn the power switch ON. This is not a malfunction. When turning the power OFF, turn OFF the power switch of the front panel, and then turn OFF the main power switch of the rear panel.



---

## 3.4 Connecting the Probe

### Connecting a Probe

Connect a probe (or measurement input cable such as a BNC cable) to the input terminal on the bottom of the front panel. The input impedance is  $1\text{ M}\Omega \pm 1\%$  and approximately  $20\text{ pF}$  or  $50\ \Omega \pm 1.5\%$ .

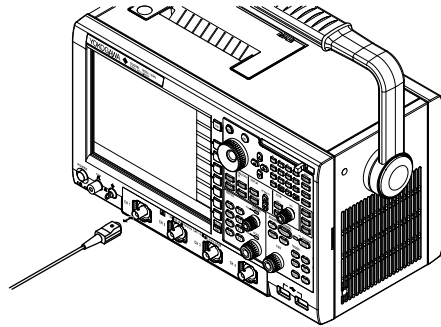

### WARNING

- Always turn OFF the power of the object to be measured when connecting it to this instrument. Connecting or disconnecting a measuring lead while the power of the object to be measured is ON is extremely dangerous.
- Do not input excessive voltages that exceed maximum input voltage, withstand voltage, or tolerance surge voltage.
- Always use a protect ground (earth) for the instrument to prevent electric shocks.
- Avoid continuous connections in environments where there is the possibility that tolerance surge voltages can be generated.



### CAUTION

- The probe interface terminal is located near the input terminal on this instrument. When connecting the probe, make sure to prevent an excessive voltage due to static electricity, etc., from being applied to the probe interface terminal, as this may damage it.
  - The probe interface terminal is located near the input terminal on this instrument. Do not short the probe interface terminal.
  - The maximum input voltage for  $1\text{ M}\Omega$ -input is  $150\text{ V}_{\text{rms}}$  when the frequency is  $1\text{ kHz}$  or less. Applying a voltage exceeding the value can damage the input section. If the frequency is above  $1\text{ kHz}$ , damage may occur even when the voltage is below the value.
  - The maximum input voltage for  $50\ \Omega$ -input is  $5\text{ V}_{\text{rms}}$  and  $10\text{ V}_{\text{peak}}$ . Applying a voltage exceeding either of these values can damage the input section.
-

## Precautions to Be Taken When Connecting Cables

- When connecting a probe to the instrument for the first time, perform phase correction of the probe as described in section 3.5, “Compensating the Probe (Phase Correction).” If you do not, frequency characteristics will not be flat, and measurements will not be correct. Perform the phase correction on each channel to which a probe is to be connected.
- Note that if the object being measured is directly connected to the instrument without using a probe, correct measurements may not be possible because of the effect of input impedance on the instrument. Use caution.

## About Probes

### Specification of standard supplied probe (model 701943), after probe phase compensation

Item	Specification	Conditions
Overall probe length	1.5 m	—
Connector type	BNC	—
Input impedance	10 M $\Omega$ $\pm$ 2%	
Input capacitance	Approx. 14 pF	
Attenuation ratio	Not exceeding 10 : 1 $\pm$ 2%	Together with an oscilloscope of input impedance 1 M $\Omega$ $\pm$ 1%
Bandwidth	DC to 500 MHz (not exceeding $-3$ dB)	
Rise time	700 ps or less (typical*)	
Maximum input voltage	600 V (DC+ACpeak) or 424 Vrms	When AC does not exceed 100 kHz

\* Typical values are typical or mean values. They are not strictly guaranteed.

### Precautions to Be Taken When Using Voltage Probes Other Than Those Provided with the Instrument

- When measuring a signal including a frequency close to 500 MHz, use a probe with a frequency range above 500 MHz.
- Be aware that correct measured values will not be displayed when using a probe having an attenuation ratio other than 1 : 1, 10 : 1, 100 : 1, 1000 : 1, 1 A : 1 V\*, 10 A : 1 V, or 100 A : 1 V.

\* 1A:1V supported by firmware version 2.40 or later.

### Setting the Probe Attenuation Ratio or Voltage-Current Conversion Factor

When using a probe not supported by the probe interface connector, follow the procedure described in Section 5.6 to set the DL9000 attenuation ratio or voltage-current conversion factor to match the probe attenuation ratio or voltage-current conversion factor. If this setting is not carried out, correct measurement values will not be displayed.

## Connecting a Probe Supported by the Probe Interface Connector

If you connect a probe supported by the probe interface connector (701943 (500 MHz passive probe), 701913 (2.5 GHz active probe PBA2500), or 701923 (2 GHz differential probe PBD2000)) to the DL9000, the probe type is automatically recognized, and the attenuation ratio set. Power is supplied to the probe through the probe interface, and therefore it is not necessary to connect the probe power cable to the probe power terminals.

### Connecting FET Probe, Current Probe, Differential Probe, or Deskew Correction Signal Source

If you are using the YOKOGAWA's FET Probes (700939), Current Probes (701932/701933), Differential Probes (700924/700925/701920/701921/701922), or Deskew Correction Signal Source (701935), use the Probe Power (option) on the DL9000 rear panel for the power supply. For details on the connection procedure, see the manual that comes with the respective product.



#### CAUTION

Do not use the Probe Power Terminal (option) on the DL9000 rear panel for purposes other than supplying power to the FET Probe (700939), Current Probe (701932/701933), Differential Probe (700924/700925/701920/701921/701922), or Deskew Correction Signal Source (701935). Also, be sure that the total current of the two Probe Power Terminals and the four Probe Interface Terminals does not exceed 1.2 A. Otherwise, the device connected to the Probe Power Terminals or to the DL9000 may break.

### Handling Precautions of the Probe Interface Terminals and Probe Power Terminals

If you are connecting the YOKOGAWA's FET Probes (700939), Current Probes (701932/701933), Differential Probes (700924/700925/701920/701921/701922), or Deskew Correction Signal Source (701935) to the Probe Power Terminals (Option) on the rear panel, be sure that the total current of the two Probe Power Terminals and the four Probe Interface Terminals does not exceed 1.2 A. Otherwise, the DL9000 operation may become unstable due to the activation of the excessive current protection circuit of the power supply.

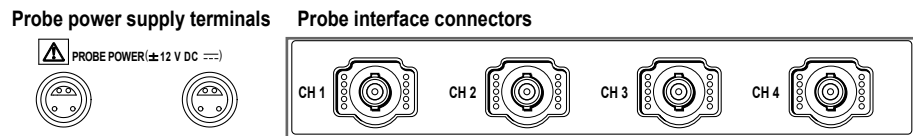

- When using current probes (701932/701933), the number of probes is limited, depending on the measured current (the current measured by the current probes). The characteristics of measured current versus current consumption for active probes that can be connected to the DL9000 are as follows.

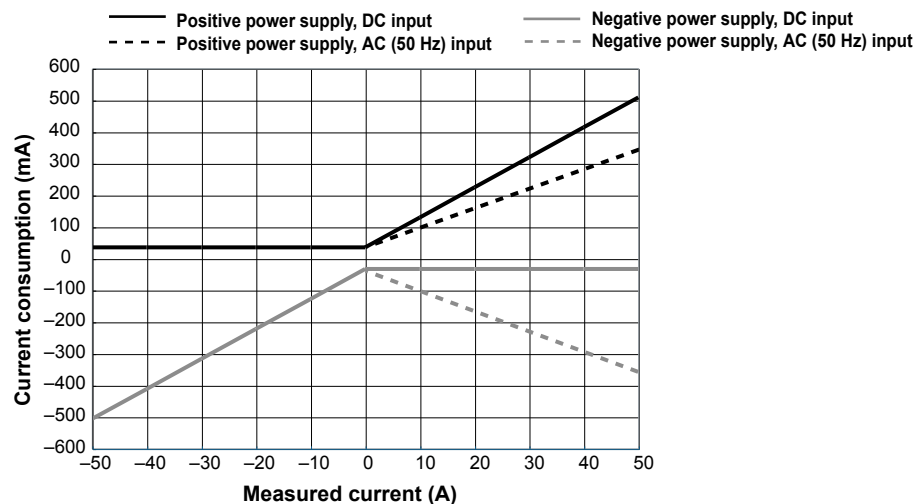

---

### 3.4 Connecting the Probe

- The current consumption of the FET probe (700939) and differential probe (700924, 700925, 701920, 701921, or 701922) should be calculated as a maximum of 125 mA for both negative and positive.
- Calculate the power consumption of the Deskew Correction Signal Source (701935) as 150 mA (positive power supply).

## 3.5 Compensating the Probe (Phase Correction)

Be sure to perform phase correction of the probe first when using a probe to make measurements.



### CAUTION

Do not apply external voltage to the signal output terminal for probe compensation adjustment. This may cause damage to the internal circuitry.

### Procedure

1. Turn ON the power switch.
2. Connect the probe to the input terminal to which the signal is to be applied.
3. Connect the tip of the probe to the signal output terminal for probe compensation adjustment on the front panel of the instrument and to the ground wire to the functional ground terminal.
4. Perform auto setup according to the procedures given in section 4.5, "Performing Auto Setup."
5. Insert a flat-head screwdriver to the phase adjustment hole and turn the variable capacitor to make the displayed waveform a correct rectangular wave.

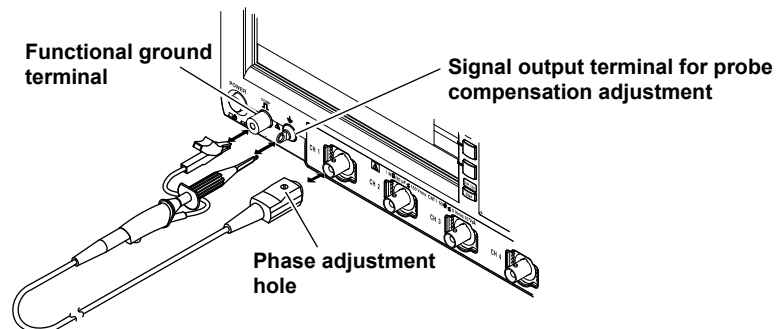

**Explanation****Necessity of Phase Correction of the Probe**

The probe comes with its phase corrected approximately to match the input capacitance of the relevant oscilloscope. However, there is variance in the input resistance and input capacitance of each input channel of individual oscilloscopes. This results in a mismatch in the voltage divider ratio between low and high frequency signals and causes uneven frequency characteristics.

There is a variable capacitor for adjusting the division ratio (trimmer) for high frequency signals on the probe. The phase is corrected by adjusting this trimmer so that even frequency characteristics are obtained.

When using the probe for the first time, make sure to perform phase correction.

Because the input capacitance varies on each channel, probe compensation is required when the probe is switched from one channel to another.

**Phase Compensation Signal**

The following square wave signal is output from the signal output terminal for probe compensation adjustment.

Frequency: Approx. 1 kHz

Amplitude: Approx. 1 V

**Differences in the Waveform due to the Phase Correction of the Probe**

Correct waveform

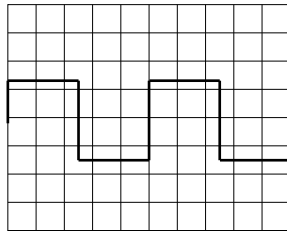

Over compensated (The gain in the high-frequency region is too high.)

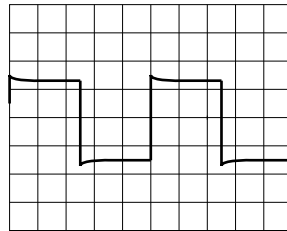

Under compensated (The gain in the high-frequency region is too low.)

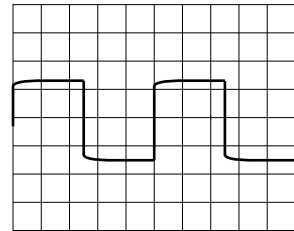

## 3.6 Setting the Date and Time

### Procedure

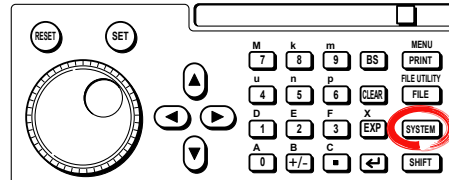

1. Press **SYSTEM**.
2. Press the **MISC** soft key.
3. Press the **Date/Time** soft key. The date and time setting dialog box opens.

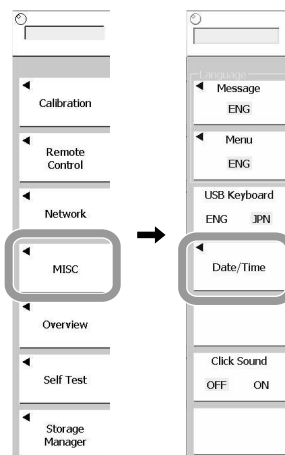

4. Press the **Display** soft key to select ON or OFF.

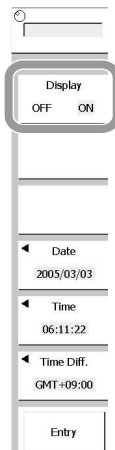

### Manually Setting the Date and Time

- **Setting the Date**

5. Press the **Date** soft key.
6. Press the **Year** soft key. This switches the target of the rotary knob.
7. Turn the rotary knob to set the **Year**.
8. Likewise, set the **Month** and **Day**.
9. Press **ESC**.

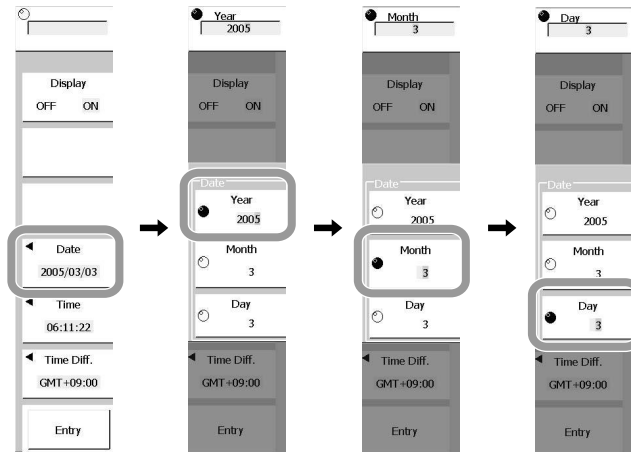

- **Setting the Time**

10. Press the **Time** soft key.
11. Press the **Hour** soft key. This switches the target of the rotary knob.
12. Turn the rotary knob to set the **Hour**.
13. Likewise, set the **Minute** and **Second**.
14. Press **ESC**.

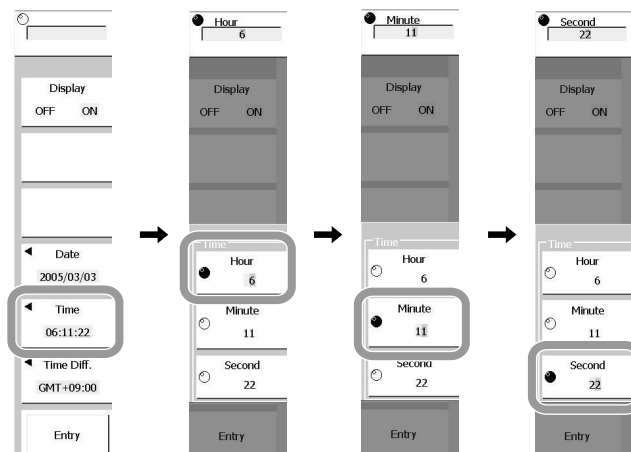



## 3.6 Setting the Date and Time

### Setting the Time Difference from GMT (Greenwich Mean Time)

5. After step 4, press the **Time Diff** soft key. A menu appears, allowing you to set the time difference from GMT.
6. Press the **Hour** soft key and then set the Hour of Time Difference From GMT (Greenwich Mean Time) in the range of –12 to 13 with the **rotary knob**.
7. Likewise, set the Minute of Time Difference From GMT in the range of 0 to 59.
8. Press the **Entry** soft key. The date and time are now registered you set. If you do not press Entry, the information you set will be disabled.

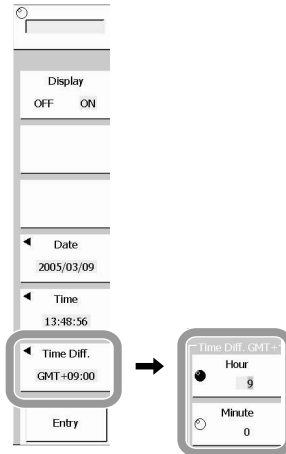

### Explanation

The date and time settings are backed up by a built-in lithium battery even if the power is turned OFF.

Leap years are also supported.

### Manual Setting

- **Date (Year/Month/Date)**  
Set the year, month and day.
- **Time (Hour/Minute/Second)**  
Set the time using a 24-hour clock.

### Setting the Time Difference from GMT (Greenwich Mean Time)

Set the time difference from GMT (Greenwich Mean Time). Make sure to set this value if you are using the network function.

- **Setting the Time Difference from GMT (Greenwich Mean Time)**  
Set the time difference in the range of –12 hours 00 minutes to 13 hours 00 minutes. For example, Japan standard time is ahead of GMT by 9 hours. In this case, set Hour to 9 and Minute to 00.
- **Checking the Standard Time**  
Check the standard time for the region where the DL9000 is to be used using one of the following methods.
  - Check the date and time settings on your PC (Windows).
  - Check the URL at right. <http://www.worldtimeserver.com/>

### Note

The DL9000 does not support daylight savings time. To set the daylight savings time, adjust the time difference from GMT.

## 4.1 Operations and Functions of Keys and the Rotary Knob

### Basic Key Operations

#### Displaying the Setup Menu of the Panel Keys

1. Press the desired panel operation key. The setup menu for that key appears.
2. Press the soft key corresponding to the desired setup menu item.

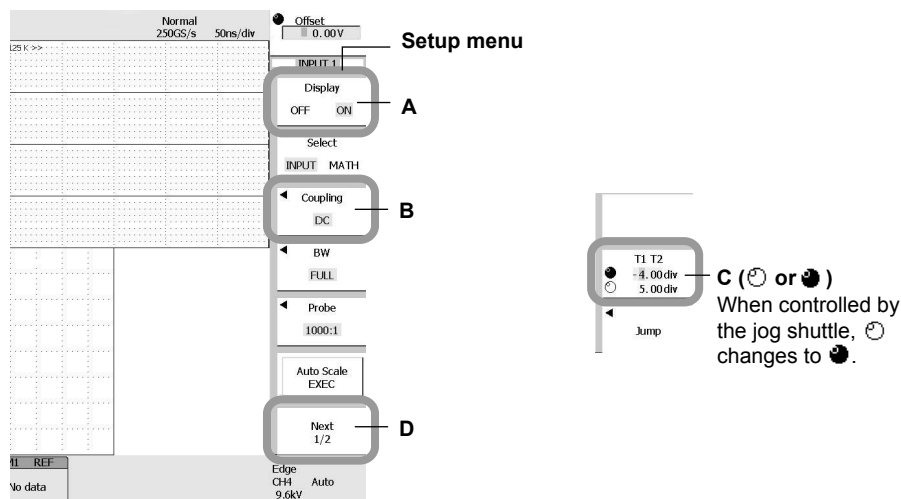

- A:** Press the corresponding soft key to switch the selected item.
- B:** Press the corresponding soft key to display the selection menu.  
To make a selection, press the soft key corresponding to the selection.
- C:** Press the corresponding soft key to set the item under jog shuttle control.  
Turn the jog shuttle to set the value. Press the arrow keys to move between digits.  
You can directly enter the value using the keys on the front panel or a USB keyboard.
- D:** Appears when there are 2 pages of the setup menu.  
Press the corresponding soft key to display page 2/2 (2 of 2) of the setup menu.  
The name changes to "Back (2/2)." To return to page 1/2 (1 of 2), press the corresponding soft key again.  
If there are 3 pages, the pages advance in the following order: page 1 → page 2 → page 3 → page 1 → page 2, and so on.

#### Note

For setup menus with multiple pages, the unit keeps the last setup menu that was open before the power was turned off. As a result, if you open the setup menu again after switching screens by pressing another panel key, the page you had been setting previously is displayed. Explanations in this manual proceed on the assumption that the first page of the setup menu appears when the panel key is pressed. The actual screen that appears when you press the panel key may differ from the explanations in this manual.

#### Displaying the Setup Menu Marked in Purple above the Panel Keys

In the explanations in this manual, "SHIFT + panel key name (purple text)" refers to the following operation.

1. Press the **SHIFT** key. The SHIFT key illuminates to indicate the shifted state. The setup menu marked in purple above the panel keys can be selected.
2. Press the panel key corresponding to the setup menu you wish to display.

## 4.1 Operations and Functions of Keys and the Rotary Knob

### Operations on the Setup Dialog Box

1. Open the setup dialog box using basic key operations or other means.
2. Turn the **rotary knob** to move the cursor to the desired item.
3. Press **SET**.

The behavior that results when you press SET varies depending on the item as described below.

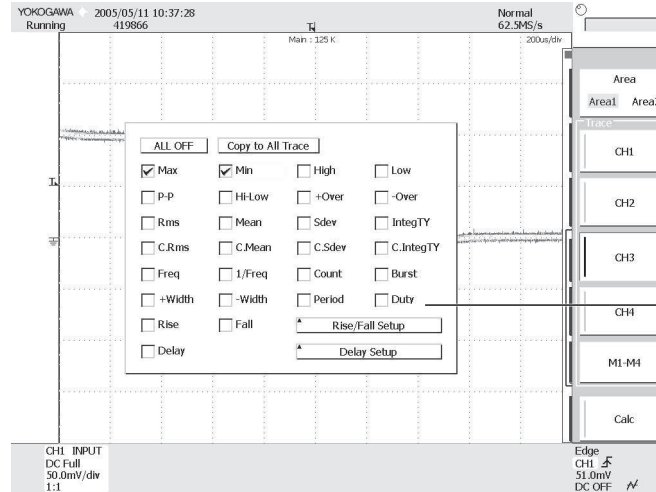

**E Setup dialog box**  
Turn the jog shuttle to move the cursor to the item you wish to set.

**When CH1 to CH4 or M1 to M4 is selected (F)**

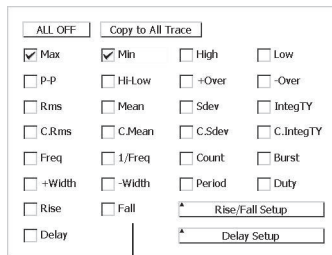

**Selection menu**

**When Calc is selected (G)**

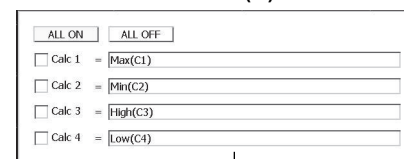

**Value entry box**

- E:** Turn the jog shuttle to move the cursor to the item you wish to set. Press SET to confirm the selection. Press SET again to release the selection.
- F:** Press SET to switch the soft key menu to the settings for the item.
- G:** Press SET to display the value entry box. Turn the jog shuttle or use the numeric keypad to set the value. Press the arrow keys to move the cursor or the selected digit. You can directly enter the value from a USB keyboard.

### Clearing the Setup Menu and Setup Dialog Box Displays

Press **ESC**. The setup menu or the dialog box shown on top is cleared from the screen.

#### **Note**

In the procedural explanations in this manual, the operation of clearing the setup menu or setup dialog box may not be given.

## 4.2 Entering Values and Strings

### Entering Values

#### Entering Values Directly Using the Dedicated Knobs

The dedicated knobs indicated below can be turned to directly enter values.

- POSITION knob
- SCALE knob
- T/DIV knob
- MAG dial

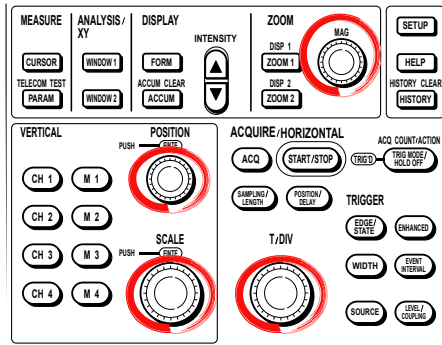

#### Entering Values Using the Rotary Knob

After selecting the setup item using the soft key, use the rotary knob to change the value (in the explanations in this manual, this operation may be indicated as “**rotary knob & SET**”).

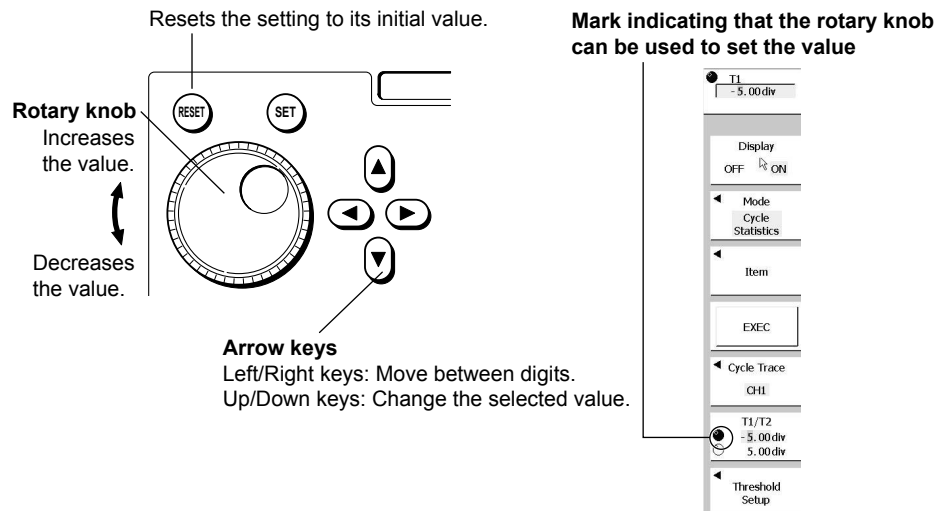

#### Note

The items that can be changed using the rotary knob are reset to their default values when the RESET key is pressed.

## Entering Strings

The keyboard displayed on the screen is used to enter character strings such as file names and comments. The rotary knob, SET, and arrow keys are used to operate the keyboard to enter the character strings.

### Operating the Keyboard

1. Turn the **rotary knob** to move the cursor to the character to be entered. Press the arrow keys on the front panel to move the cursor left/right and up/down.
2. Press **SET** key to enter the character.  
To enter a numeric value, you can use the numeric keypad on the front panel. To enter letters, press the INS soft key, then enter the characters. In insertion mode, the cursor appears between characters.
3. Repeat steps 1 and 2 to enter all the characters in the string.
4. You can press the **Enter** soft key or  key on the front panel to confirm the string and clear the keyboard.

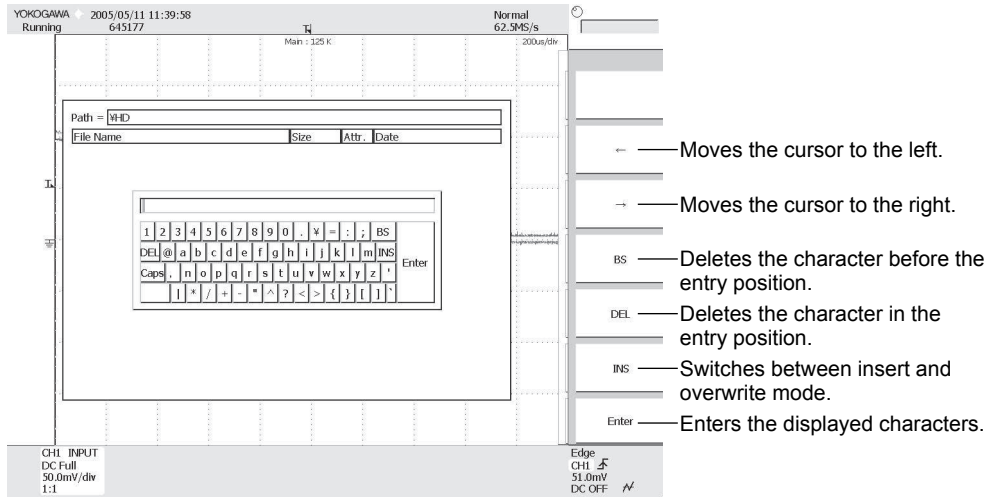

### Note

- Multiple @ characters cannot be entered consecutively.
- File names are not case-sensitive. Comments are case-sensitive. In addition, the following file names cannot be used due to limitations of MS-DOS.  
AUX, CON, PRN, NUL, CLOCK, COM1 to COM9, and LPT1 to LPT9

## 4.3 Operating the DL9000 Using a USB Keyboard or a USB Mouse

### Connecting a USB Keyboard

You can connect a USB keyboard for entering file names, comments, and other information.

#### Keyboards That Can Be Used

The following keyboards that conform to USB Human Interface Devices (HID) Class Version 1.1 can be used.

- When the USB keyboard language is English: 104 keyboard
- When the USB keyboard language is Japanese: 109 keyboard

#### DL9000s with Firmware Version before 2.40

The languages available for the USB keyboard are those of the message language setting in section 17.1. A Japanese keyboard can be used if the message language is set to Japanese. An English keyboard can be used if the message language is set to something other than Japanese.

#### DL9000s with Firmware Version 2.40 or Later

Set the USB keyboard language according to the instructions in section 17.3.

#### Note

- Connect only the keyboards that are allowed.
- The operation of USB keyboards connected to a USB hub or those that have mouse connectors is not guaranteed.
- For USB keyboards that have been tested for compatibility, contact your nearest YOKOGAWA dealer.

#### USB Connector for Connecting Peripheral Devices

Connect the USB keyboard to the USB connector for connecting peripheral devices on the front panel. Two ports are available.

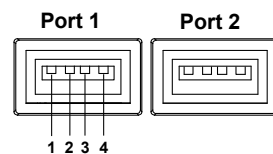

Pin No.	Signal Name
1	VBUS: +5 V
2	D-: -Data
3	D+: +Data
4	GND: Ground

### 4.3 Operating the DL9000 Using a USB Keyboard or a USB Mouse

#### Connection Procedure

When connecting a USB keyboard, directly connect the keyboard to the DL9000 using a USB cable as shown below. You can connect the USB cable regardless of whether the power to the DL9000 is ON or OFF (supports hot-plugging). Connect the type A connector of the USB cable to the DL9000; connect the type B connector to the keyboard. When the power switch is ON, the keyboard is detected and enabled approximately six seconds after it is connected.

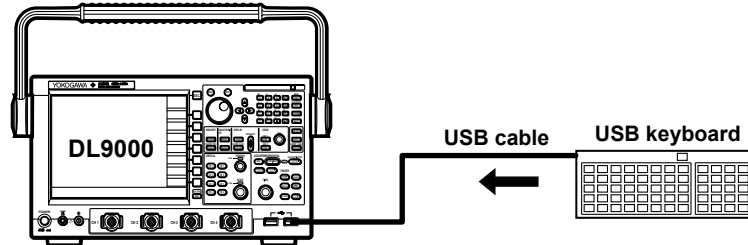



#### Note

- Do not connect USB devices other than a compatible USB keyboard, USB mouse, USB printer, and USB storage to the USB connector for connecting peripheral devices.
- Do not connect multiple keyboards. Only 1 keyboard, 1 mouse, and 1 printer can be connected.
- Do not connect and disconnect multiple USB devices successively. Allow at least ten seconds between the connection and disconnection of a USB device and the connection and disconnection of the next USB device.
- Do not disconnect the USB cable after the power is turned ON until key operation becomes possible (approximately 20 to 30 s).

#### Entering File Names, Comments, and Other Items

When a keyboard is displayed on the screen, you can enter the file name, comment, and other items using a USB keyboard.

#### Entering Values from a USB Keyboard

You can enter values from a USB keyboard for items with the  or  mark.

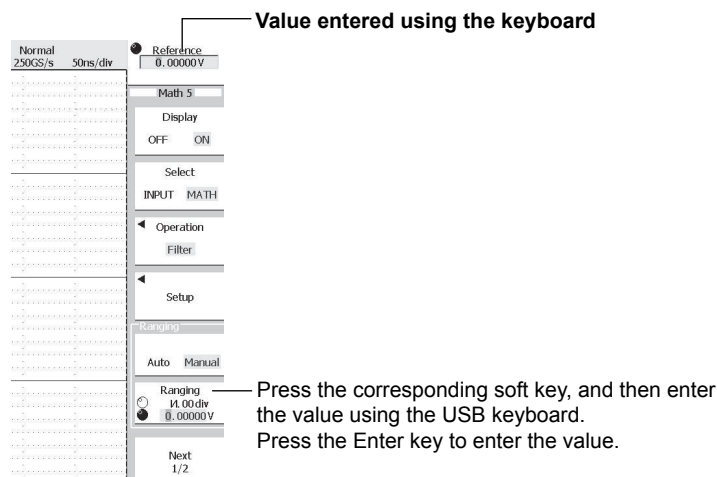

## Operations Using a USB Mouse

You can use a USB mouse to operate the DL9000 as you would use the front panel keys. In addition, you can point to a desired item on a menu and click the item. This is analogous to pressing a soft key corresponding to a menu and pressing the SET key.

### USB Connector for Connecting Peripheral Devices

Connect a USB mouse to the USB connector for connecting peripheral devices on the front panel of the DL9710L. For details on the USB connector for connecting peripheral devices, see page 4-6.

### Compatible USB Mouse

A USB wheel mouse conforming to USB HID Class Version 1.1 can be used.

#### **Note**

- For USB mouse devices that have been tested for compatibility, contact your nearest YOKOGAWA dealer.
- Some items cannot be specified when using a mouse without a wheel.

### Connection Procedure

If you want to connect a USB mouse to the DL9000, connect the mouse to the USB connector for connecting peripheral devices. You can connect/disconnect the USB mouse connector regardless of the power ON/OFF state of the DL9000 (supports hot-plugging). When the power switch is turned ON, the mouse is detected approximately six seconds after it is connected, and a pointer (  ) is displayed.

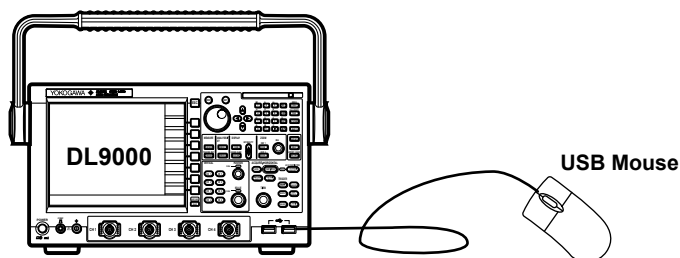

#### **Note**

- Do not connect USB devices other than a compatible USB keyboard, USB mouse, USB printer, and USB storage to the USB connector for connecting peripheral devices.
- There are two USB connectors for connecting peripheral devices. However, do not connect mouse devices to both connectors at the same time.



### 4.3 Operating the DL9000 Using a USB Keyboard or a USB Mouse

#### USB Mouse Operation

- **Setup Menu Operation (Similar to the Soft Key Operation)**

##### Selecting an Item on the Setup Menu

Left-click the item you wish to select on the setup menu.

If another menu appears when you select an item, move the pointer to the new menu displaying the item you wish to select and left-click the item.

If an item such as ON or OFF appears when you select an item, move the pointer to the new frame and left-click within the frame to switch the selected item.

For menus in which items are selected using rotary knob & SET (see page 4-3), left-click the desired item. Left-click again to confirm the new setting and close the selection dialog box. You can turn the mouse wheel to select scrollable items.

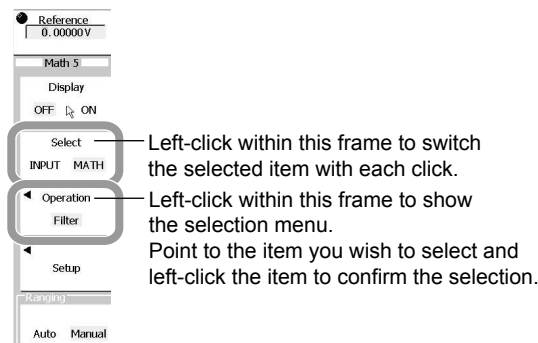

- **Selecting Toggle Box Items on the Dialog Box**

Move the pointer to the item you wish to select and then left-click the item.

The item is selected. Click the selected item again to deselect it.

To close the dialog box, press the **ESC** key.

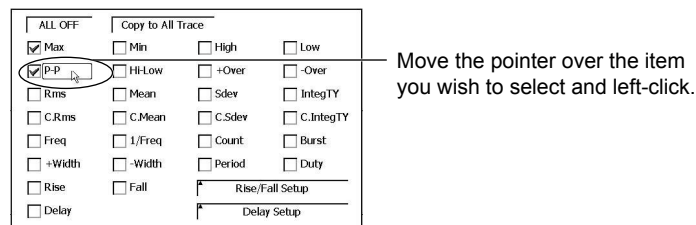

#### **Note**

To close an error dialog box, press the **ESC** key on the front panel.

## 4.4 Initializing Settings

### Procedure

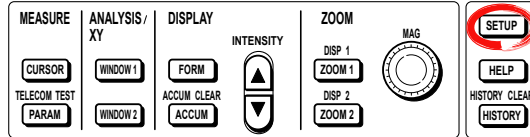

### Executing Initialization

1. Press **SETUP**. The SETUP menu appears.
2. Press the **Initialize** soft key. Initialization is executed.

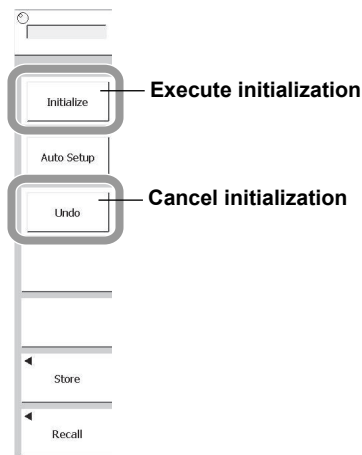

### Canceling Initialization

3. Press the **Undo** soft key. The settings return to the conditions that existed immediately before initialization.

### **Explanation**

You can restore the factory default settings. This is useful when you wish to clear previous settings or start measurement from scratch.

#### **Initialization**

Initialization refers to the act of restoring the factory default settings.

#### **Items That Cannot Be Initialized**

- Date/Time setting
- Settings related to communications
- English/Japanese language setting

#### **Canceling Initialization**

If you initialize the settings by mistake, you can press the Undo Initialize soft key to return to the settings that existed before the initialization. When you turn OFF the power switch, the settings that existed immediately before initialization are cleared. Therefore, the Undo operation is not possible in this case.

#### **Initializing All the Settings**

When the power is turned ON while holding down the RESET key, all settings excluding the date/time setting (display ON/OFF is initialized) are initialized to factory default settings.

## 4.5 Performing Auto Setup

### Procedure

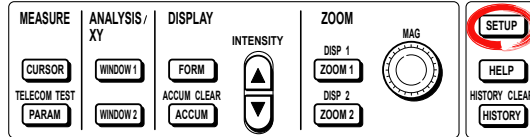

### Executing Auto Setup

1. Press **SETUP**. The SETUP menu appears.
2. Press the **Auto Setup** soft key. Auto setup is executed.  
When auto setup is executed, waveform acquisition starts automatically.

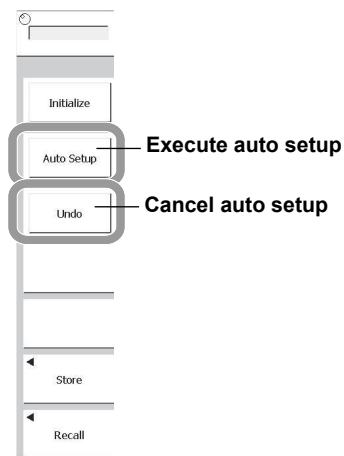

### Canceling Auto Setup

3. Press the **Undo** soft key. The settings are set back to their original condition.

## 4.5 Performing Auto Setup

### Explanation

The auto setup function automatically sets the key settings such as V/div, T/div, and trigger level that are appropriate for the input signal.

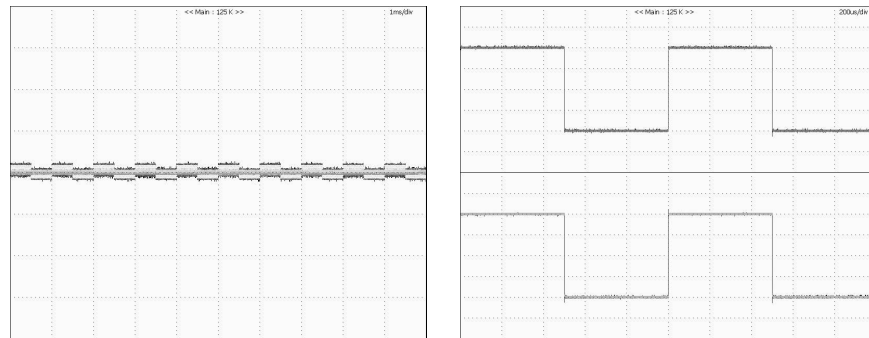

Before auto setup

After auto setup

### Center Position after Auto Setup

The center position after auto setup is 0 V.

### Applicable Channels

Auto setup is performed on all channels.

### Loaded Waveforms

When auto setup is executed, loaded waveforms are unloaded (cannot be recovered using the Undo soft key).

### Canceling Auto Setup

Pressing the Undo soft key to sets the DL9000 back to the settings that existed before auto setup. However, when you turn OFF the power switch, the settings that existed immediately before auto setup are clear. Therefore, the Undo operation is not possible in this case.

### Applicable Waveforms for Auto Setup

Frequency	Approx. 50 Hz or higher
Absolute value of the input voltage	Maximum value is greater than or equal to approximately 20 mV (1:1)
Type	Repetitive waveform (that is not complex)

### Note

The auto setup function may not work properly if the waveform includes DC components or high-frequency components.

**Setup Data after Executing Auto Setup**

<b>Related CH1 to CH4</b>	
Select	INPUT
Position	0 div
Coupling	DC1 M $\Omega$ except DC50 $\Omega$ No change for DC50 $\Omega$
BW	FULL
Offset	0 V
Invert	OFF
<b>M1 to M4</b>	
Display	OFF
<b>Acquisition</b>	
Mode	Normal
Hireso	OFF
<b>SAMPLING/LENGTH</b>	
Interp	ON
Repetitive	OFF (ON for firmware versions before 2.40.)
Interleave	OFF
Length	125 kW
<b>Trigger</b>	
Mode	Auto
HoldOff	Min (20 ns)
Delay	OFF
Position	50%
Type	Edge
Polarity	Rise
Coupling	DC
Hysteresis	Small
HF Rej	OFF
Window	OFF
<b>Accumulation</b>	
Mode	OFF
<b>Screen display</b>	
Mapping	Auto
Dot Connect	Sine
Intensity	10 (Default)
Brightness	8 (Default)
<b>Zoom</b>	
Zoom	OFF
Main	ON
<b>Cursor</b>	
Display	OFF
<b>Waveform parameter</b>	
Display	OFF
<b>Telecom Test</b>	
Display	OFF
<b>Analysis</b>	
Display	OFF
<b>Items depending on input signals</b>	
CH On/Off	ON when detecting voltage of $\pm 7$ mV or higher, OFF when detecting less than $\pm 7$ mV
V/div	Select the highest range of sensitivity that does not exceed $\pm 3.5$ div
Trigger Level	Center
Trigger Source	Channel whose input amplitude (Max-Min) is 1 division or greater with the lowest frequency
T/Div	The fastest sweep range that exceeds 5 ms/div whose input amplitude is 1 division or greater and which the fastest frequency can be observed with 2 cycles or greater
FORM VT Form	1 to 4 windows based on the active channels

## 4.6 Storing and Recalling Setting Information

### Procedure

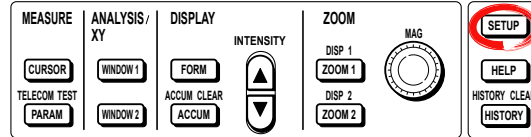

1. Press **SETUP**. The SETUP menu appears.

### Storing Setting Information

2. Press the **Store** soft key. A menu to select the destination appears.
3. Select where to store the information, from internal memory locations **#1** to **#4**.
  - \* On products with firmware version 2.82 or later, you can select the storage destination from internal memories **#1** to **#12**. To select a memory between **#7** and **#12**, press the **Next** soft key on the menu beforehand.

### Recalling Setting Information

2. Press the **Recall** soft key. A menu to select the setting data to be recalled appears.
3. Select the setting data to be recalled, from internal memory locations **#1** to **#4**.
  - \* On products with firmware version 2.82 or later, you can select the setup data to be recalled from internal memories **#1** to **#12**. To select a memory between **#7** and **#12**, press the **Next** soft key on the menu beforehand.

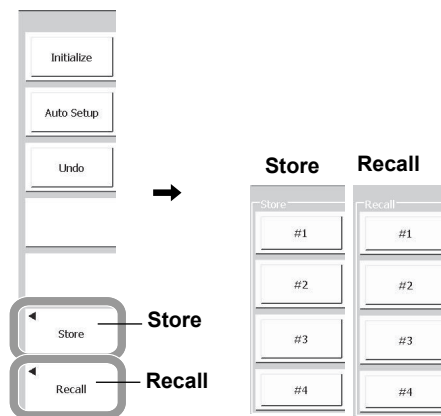

### Menu on products with firmware version 2.82 or later

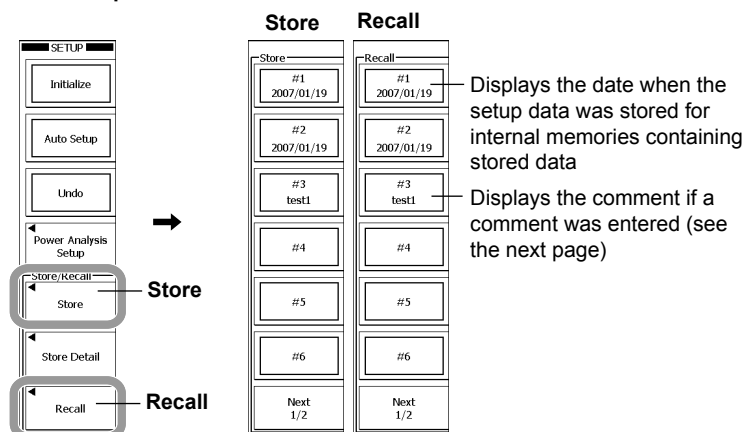

**Store Data Details (Applicable to products with firmware version 2.82 or later)**

2. Press the **Store Detail** soft key. The Store Detail dialog box appears.

- **Entering a Comment**

3. Turn the **rotary knob** to move the cursor to Comment, and press **SET**. A keyboard appears.

4. Enter a comment according to the procedure given in section 4.2. Then, press **Enter**.

- **Prohibiting the Overwriting of the Setup Data**

5. Turn the **rotary knob** to move the cursor to Lock. Press **SET** to enter a check mark. Press **SET** again to clear the check mark.

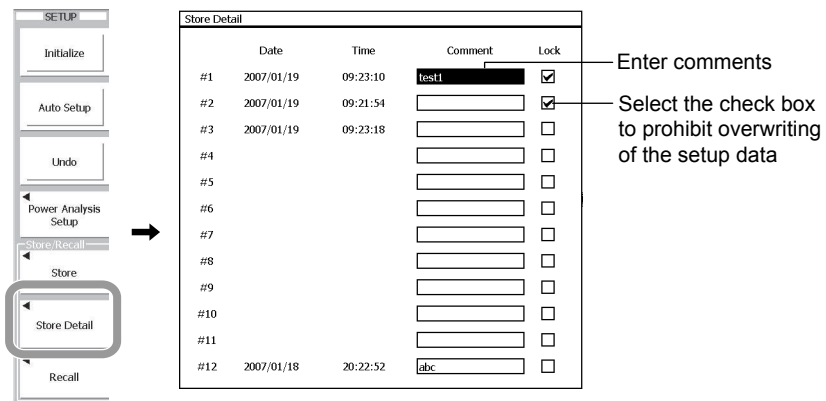
**Explanation**

Up to 12\* sets of setup data can be stored to the internal memory. You can load setup data stored in the past to produce the same settings.

**Stored Items**

All items set using the soft key menu or rotary knob and the channel ON/OFF state are stored.

**Storing the Setup Data**

You can store the setup data in any of the 4\* internal memories, #1 to #4.

If data is already stored in the internal memory of the specified number, the data is overwritten\*.

**Recalling the Setup Data**

You can recall the setup data that is stored in any of the 4 internal memories, #1 to #4.

You can only select memories that have setup data stored.

\* The specifications have been changed on products with firmware version 2.82 or later as follows:

- The internal memories for storing and recalling have been increased to 12.
- A comment consisting of up to 16 characters can be entered, and the comment is displayed under the internal memory number of the Store/Recall menu.
- Overwrite protection can be specified on the detail menu of the store data.

**Note**

- The stored setup data are not cleared even if you initialize the settings on the DL9000.
- If you recall setup data while waveforms are being acquired, waveform acquisition is restarted.



## 4.7 Starting/Stopping Waveform Acquisition

### Procedure

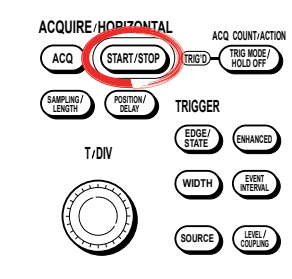

### Starting/Stopping Waveform Acquisition

Press **START/STOP**. Waveform acquisition starts/stops.  
Waveform is being acquired when the key illuminates.

### Explanation

#### Waveform Acquisition and Indicator Display

- Waveform is being acquired when START/STOP illuminates. "Running" is displayed on the upper left corner of the screen.
- Waveform stops being acquired when START/STOP does not illuminate. "Stopped" is displayed on the upper left corner of the screen.

#### Operation When the Acquisition Mode Is Set to Averaging Mode

- Averaging is stopped when waveform acquisition is stopped.
- Averaging starts again when waveform acquisition is restarted.

#### START/STOP Operation during Accumulation

Accumulation is temporarily aborted when acquisition is stopped.

When restarting the acquisition, the DL9000 clears waveform that was already acquired and restarts accumulation.

#### **Note**

- When the trigger mode is other than Single, starting waveform acquisition clears data already stored in acquisition memory.
- A snapshot function that keeps the current displayed waveform on the screen is also available. You can update the display without stopping waveform acquisition (see section 8.6).

## 4.8 Performing Calibration

### Procedure

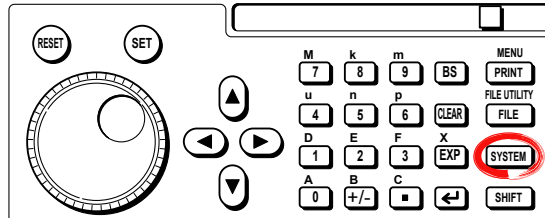

1. Press **SYSTEM**.
2. Press the **Calibration** soft key. The Calibration menu appears.
3. Press the **Cal Exec** soft key. Calibration is executed.
4. To set auto calibration press the **Auto Cal** soft key to select ON or OFF.

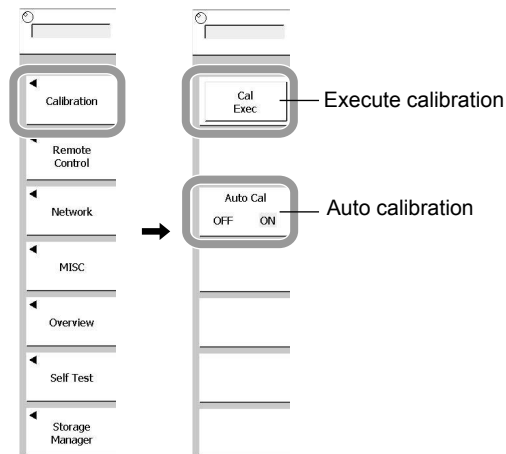

### Explanation

#### Calibration

The following items are calibrated. Perform calibration when you wish to measure waveforms with high accuracy.

- Ground level and gain of the vertical axis
- Trigger threshold level
- Time measurement value during repetitive sampling

#### Note

---

The calibration described above is performed automatically when the power switch is turned ON.

---

#### Precautions to Be Taken When Performing Calibration

- Always allow the instrument to warm up for at least 30 minutes after the power is turned ON before starting calibration. If calibration is performed immediately after the power is turned ON, the calibration may be inaccurate due to drift caused by fluctuation in the temperature of the instrument.
- Calibration must be performed when the temperature of the instrument is stable and is between 5°C and 40°C (preferably at 23°C  $\pm$ 5°C).
- Do not apply a signal when performing calibration. Calibration may be executed incorrectly when an input signal is being applied.

#### Auto Calibration

Calibration is automatically performed when T/div is changed and waveform acquisition is started for the first time after the following time elapses after turning ON the power.

- 3 minutes
- 10 minutes
- 30 minutes
- 1 hour and every hour thereafter

If calibration is executed while a signal is applied to the DL9000, it is recommended that the DL9000 be recalibrated without applying a signal.

## 5.1 Switching the Display of Input Waveforms ON and OFF

### Procedure

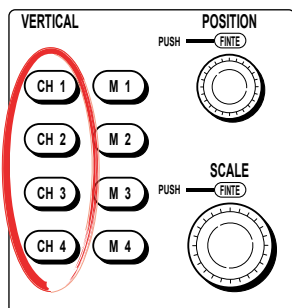

#### Switching the Display ON

1. Press the key for the channel to be displayed, from **CH1** to **CH4**. The key lights, and the waveform appears.  
The menu for the channel settings appears.
2. Press the **Select** soft key, and select Input.

#### Switching the Display OFF

1. Press the key for the channel to be turned off, from **CH1** to **CH4**.  
The menu for the channel settings appears.
2. Press the **Display** soft key, and select OFF.

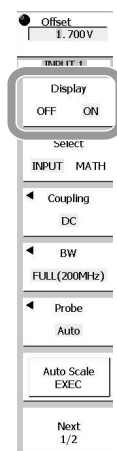

### Explanation

The channel keys (CH1 to CH4) set to ON light.

When a channel key is off, press the key once to change the indication to ON, lighting the key.

When a channel key is lit, press the key twice in succession, changing the indication to OFF, and turning off the key.

#### Note

- Scale values (section 5.12) and waveform labels (section 8.5) can also be displayed using the DISPLAY menu.
- If interleave mode (see section 7.5) is ON, CH2 and CH4 cannot be displayed.

## 5.2 Setting the Offset Voltage

### Procedure

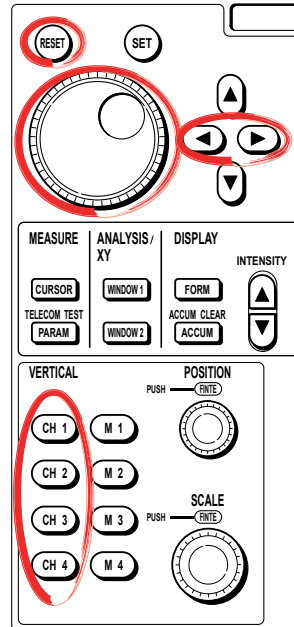

1. Press one of the **CH1** to **CH4** keys to select the channel.
2. Display menu 1/2.
3. Set the offset value with the **rotary knob**.  
The column can be moved with the arrow keys.

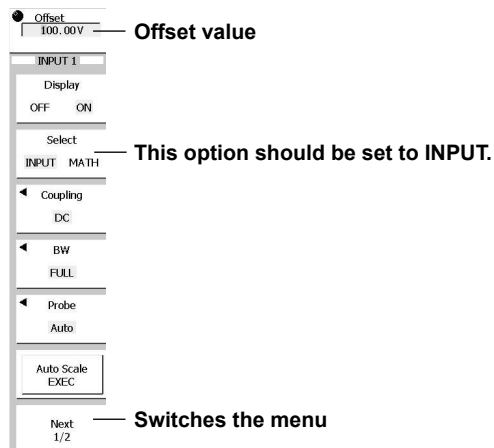

**Explanation**

The setting of the offset voltage is effective for all the input couplings: **AC1 M $\Omega$** , **DC1 M $\Omega$** , **DC50  $\Omega$** , and **GND**.

You can also make the setting for the input waveform (when Select is set to Input).

**Selectable Range of Offset Voltage**

Voltage Sensitivity (Probe = 1 : 1)	Offset Voltage Selectable Range
2 mV/div to 50 mV/div	-1.0 V to 1.0 V
0.1 V/div to 0.5 V/div	-10.0 V to 10.0 V (-5.0 V to 5.0 V for DC 50 $\Omega$ )
1 V/div to 5 V/div	-100.0 V to 100.0 V

The resolution is 0.01 divisions. For 2 mV/div, the resolution is 0.02 mV.

**Resetting the Offset Value**

Pressing the **RESET** key resets the offset value to 0 V.

**Note**

- If you change the probe attenuation, the offset changes proportionally to reflect the new attenuation rate.
- The offset voltage does not change, even if you change the voltage sensitivity. However, an offset voltage outside the above selectable range is set to the maximum or minimum value that could be selected for the voltage sensitivity. If the voltage sensitivity is returned to its previous value without changing the offset voltage then the offset voltage also returns to its previous value.

## 5.3 Setting the Vertical Position of the Waveform

### Procedure

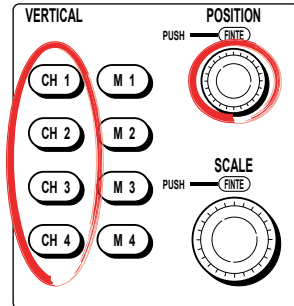

1. Press one of the **CH1** to **CH4** keys to select the channel.
2. Use the **POSITION knob** to set the vertical position.  
By pressing the POSITION knob, lighting the FINE indicator, you can make settings with a higher resolution.

### Explanation

#### Range of Movement

The vertical position can be moved within a range of  $\pm 4$  divisions from the center of the waveform area.

#### Resolution

Firmware version 2.40 or later: 0.5 div (or 0.02 div for FINE)

Firmware version before 2.40: 1 div (or 0.01 div for FINE)

#### Confirming the Vertical Position

For input waveforms and computed waveforms, the ground level and vertical position are marked to the left of the waveform area.

500 mV/div, Offset: -1 V, Position: 0 div

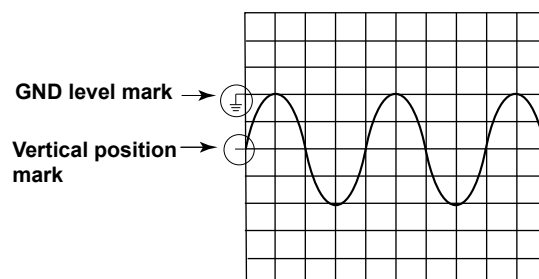

#### Note

If the position is changed after the waveform is acquired then data that is beyond the measurement range is handled as overflow data. Overflow data may result in a chopped waveform, as in the following figure.

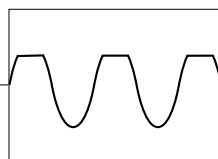

## 5.4 Setting the Input Coupling

### Procedure

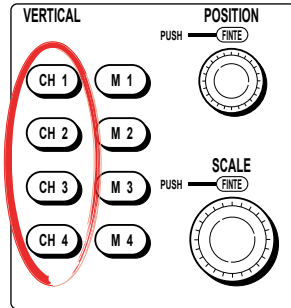

1. Press one of the **CH1** to **CH4** keys to select the channel.
2. The 1/2 menu appears.
3. Press the **Coupling** soft key. The coupling selection menu appears.
4. Press the soft key corresponding to the desired coupling.

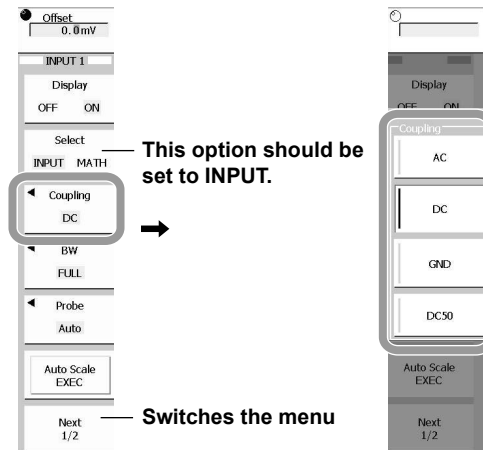

### Note

When a probe supported by the DL9000 probe interface is used, the input coupling is set automatically.



### Explanation

#### Selecting the Input Coupling

You can select the method of coupling the input signal to the vertical control circuit in the following ways.

AC: Acquires and displays only the AC component of the input signal.

DC: Acquires and displays all the components (DC and AC) of the input signal (1 M $\Omega$  input).

This can only be selected when measuring voltage.

GND: Checks the ground level.

DC50: Acquires and displays all the components (DC and AC) of the input signal (50  $\Omega$  input).

#### Input Coupling and Frequency Characteristics

The following shows the frequency characteristics when AC or DC are selected.

Note that when AC is selected, low frequency signals or signal components are not acquired (as shown in the figure below).

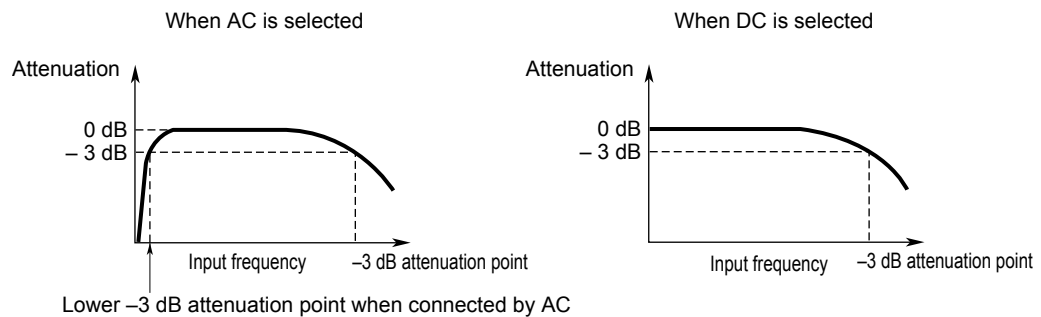

### CAUTION

- The maximum input voltage for the 1-M $\Omega$  input is 150 Vrms when the frequency is 1 kHz or less. Applying a voltage exceeding this maximum can damage the input section. If the frequency is above 1 kHz, the input section may be damaged even when the voltage is below the values specified above.
- The maximum input voltage for the 50- $\Omega$  input is 5 Vrms and 10 Vpeak. Applying a voltage exceeding either of these voltages can damage the input section.

## 5.5 Setting Bandwidth Limits

### Procedure

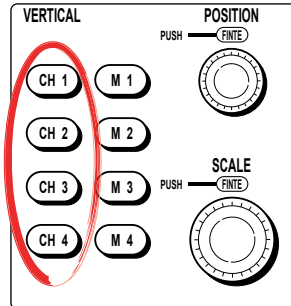

1. Press one of the **CH1** to **CH4** keys to select the channel.
2. The 1/2 menu appears.
3. Press the **BW** soft key. The Bandwidth menu appears.
4. Press the soft key corresponding to the desired bandwidth. If "8 M - 1 MHz" or "500 - 8 kHz" is selected, another Bandwidth menu appears. Press a soft key to select the bandwidth.

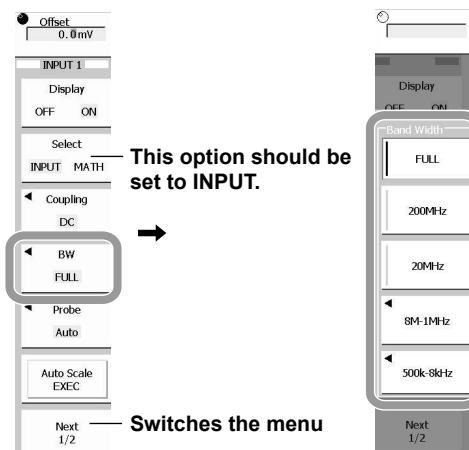

### Note

The bandwidth limit is set for each channel. Set the bandwidth limit for all desired channels.

### Explanation

#### Bandwidth

It is possible to remove the high frequency components from the input signal. The frequency characteristics when the bandwidth has been given limits are shown below. If you select FULL, the largest bandwidth is selected.

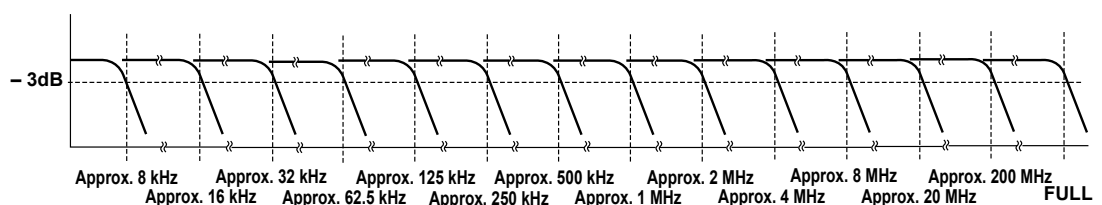

In high resolution mode, a 200 MHz filter is used internally even for FULL.

## 5.6 Setting the Probe Attenuation

### Procedure

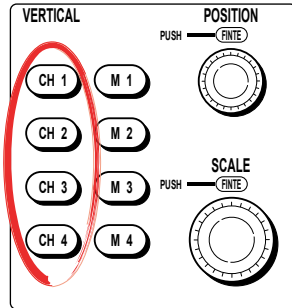

1. Press one of the **CH1** to **CH4** keys to select the channel.
2. The 1/2 menu appears.
3. Press the **Probe** soft key. The Probe menu appears.
4. Press the soft key corresponding to the desired type (attenuation ratio).

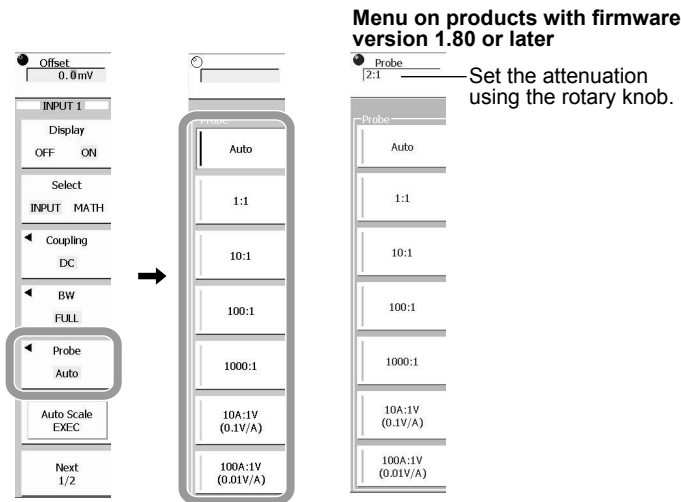

### Explanation

The following probe types can be selected for each channel:

- AUTO, 1 : 1, 10 : 1, 100 : 1, 1000 : 1, 10 A : 1 V, 100 A : 1 V.
- 1 : 1 to 1000 : 1 are probe attenuation settings.
- 10 A : 1 V and 100 A : 1 V are probe output current rates.
- If AUTO is selected then the attenuation is automatically selected when the probe is connected to the corresponding probe interface.

In addition to using the soft keys to products with firmware version 1.80 or later, you can now select the probe attenuation using the rotary knob. When using the rotary knob, you can select from the choices below. The menu corresponding to the attenuation that you select with the rotary knob is highlighted.

Auto, 1:1, 2:1, 5:1, 10:1, 20:1, 50:1, 100:1, 200:1, 500:1, 1000:1, 1A : 1V (1A:1V supported by firmware version 2.40 or later), 10A:1V, or 100A:1V

### Note

If the probe type is not set correctly, the voltage and scale values of the input signals will not be displayed correctly. For example, if you set the attenuation to 1 : 1 when you are using a 10 : 1 voltage probe, the automatically determined waveform amplitude will be displayed as 1/10th the actual value.

## 5.7 Setting the Scale

### Procedure

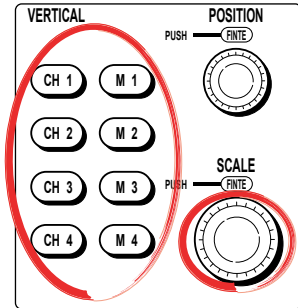

1. Press one of the **CH1** to **CH4** or **M1** to **M4** keys to select the channel.
2. Turn the **SCALE knob** to set the V/div value.  
By pressing the SCALE knob, lighting the FINE indicator, you can make settings with a higher resolution.

### Explanation

#### Setting V/div

The V/div (voltage sensitivity) setting is used to adjust the displayed amplitude of the waveform for easy measurement. You can set the value in terms of the voltage per division of the screen grid. V/div is set in steps of 1-2-5 (i.e., 1 V/div, 2 V/div, and 5 V/div).

#### Note

- The displayed waveforms do not change if you turn the SCALE knob while waveform acquisition is stopped. The new V/div value takes effect the next time waveform acquisition is restarted.
- Turning the SCALE knob while acquisition is stopped has no effect on cursor measurement values and automated measurement values of waveform parameters. The displayed values are for the determined V/div setting.

## 5.8 Setting Time Axis (T/div)

### Procedure

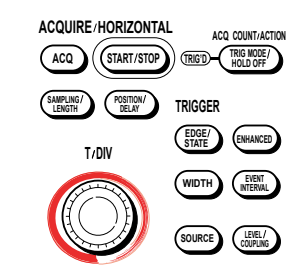

Turn the **T/DIV knob** to set the T/div value.

### Note

- If the T/DIV knob is turned while acquisition is stopped, the new T/div value appears in the upper center of the screen and takes effect when acquisition is restarted.
- See Appendix 1, "Relationships Among the Time Setting, Sample Rate, and Record Length" for the relationship between T/div and the sample rate.

### Explanation

You can set the value in terms of the time per division of the screen grid.

#### Selectable T/div Range

500 ps/div to 50 s/div

#### T/div and Roll Mode

Roll mode is used if T/div is set to a value between 100 ms/div and 50 s/div under the following conditions:

- Acquisition mode is set to a mode other than averaging.
- Trigger mode is set to auto, auto level, or single.

## 5.9 Using the Auto Scale Function

### Procedure

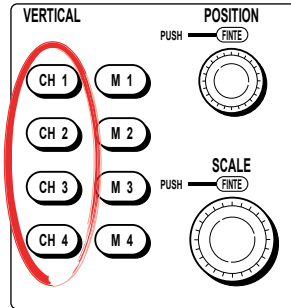

1. Press one of the **CH1** to **CH4** keys to select the channel.
2. Press the **Select** soft key to select INPUT or MATH.

#### For INPUT:

3. Press the **Auto Scale EXEC** soft key for INPUT.

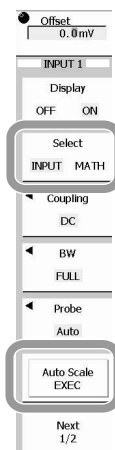

#### For MATH:

3. Press the **Ranging** soft key to select Auto.

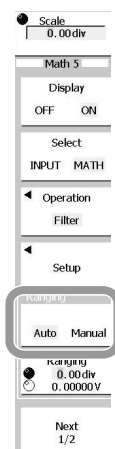

## 5.9 Using the Auto Scale Function

---

### Explanation

Auto Scale can be set for each channel.

The following are set in the following ways when Auto Scale EXEC is used:

V/div	Displayed so that the entire amplitude of the waveform can be seen without changing the vertical position.
Offset	0 V when the input coupling is AC. Center = (Max – Min)/2 when the input coupling is DC.
Trig Level	DC offset position.

## 5.10 Canceling the Offset Value

### Procedure

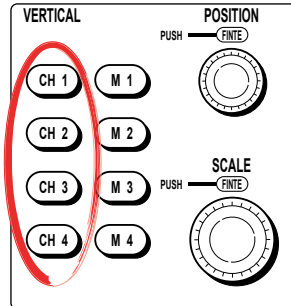

1. Press one of the **CH1** to **CH4** keys to select the channel.
2. Press the **Next 1/2** soft key.
3. Press the **Offset Cancel** soft key to select ON or OFF.

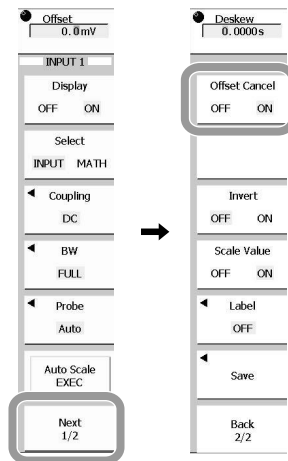

### Explanation

Offset cancel can be set to ON or OFF for each channel. The default setting is OFF.

OFF	The offset value is not applied to computations and the results of automated measurements. The waveform is observed without subtracting the offset voltage (DC voltage) from the input signal. The vertical position of the screen corresponds to the offset voltage.
ON	The offset value is applied to computations and the results of automated measurements. The offset value specified for each channel can be used to subtract an unneeded offset voltage (DC voltage) from the input signal for waveform observation. The vertical position is set to 0 V



## 5.11 Displaying the Waveform Inverted

### Procedure

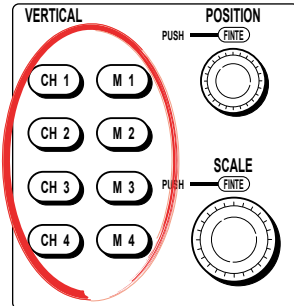

1. Press one of the **CH1** to **CH4** or **M1** to **M4** keys to select the channel.
2. Press the **Next 1/2** soft key.
3. Press the **Invert** soft key to select ON.

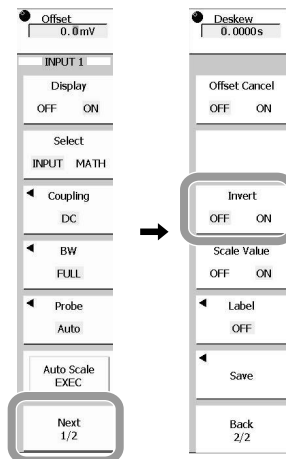

### Explanation

#### Inverted Objects

The input signals of CH1 to CH4 and M1 to M4 can be individually inverted. The display is inverted with respect to the center of the vertical position.

#### Inverted Display

- Cursor measurements, automated measurement of waveform parameters, and computations are performed on the original waveform.
- Trigger functions are performed on the original waveform even when the display is inverted.

## 5.12 Turning the Display of the Scale Value ON/OFF

### Procedure

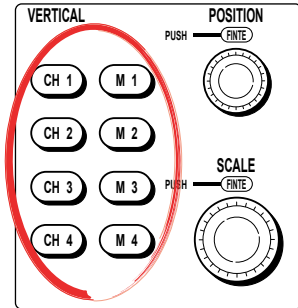

1. Press one of the **CH1** to **CH4** or **M1** to **M4** keys to select the channel.
2. Press the **Next 1/2** soft key.
3. Press the **Scale Value** soft key to select ON or OFF.

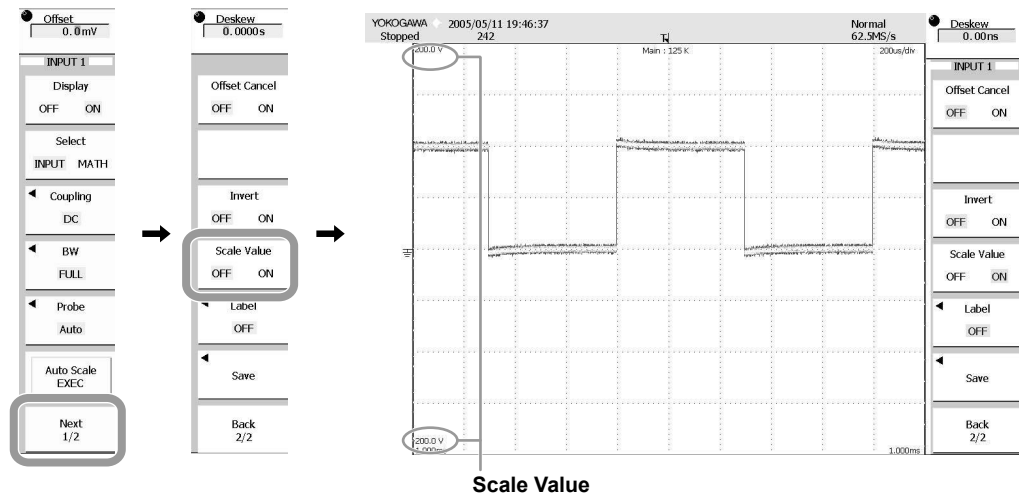

### Explanation

The display of the maximum and minimum values for the vertical and horizontal axes, and the scale values for the maximum and minimum values, can be turned ON/OFF for each channel.

### Note

The scale value is displayed to the left of the waveform. Or, if there is no space to the left of the waveform, it is displayed to the right.

## 5.13 Correcting the Skew

### Procedure

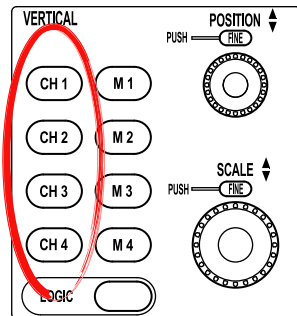

1. Press one of the **CH1** to **CH4** keys to select the channel.
2. Press the **Next 1/2** soft key.
3. Turn the **rotary knob** to set the screw correction value of the analog signal. You can move between the digits using the arrow keys. Pressing RESET resets the value to 0.00 ns.

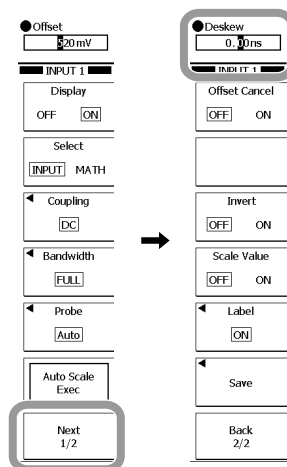

### Explanation

#### Correcting the Skew

You can observe the signal by correcting the time offset (skew) of the analog signal with respect to another signal. You can make corrections on each channel, CH1 to CH4.

Selectable range	-80.00 to 80.00 ns (the default value is 0.00 ns)
Resolution	0.01 ns

# 6.1 Setting the Trigger Mode

## Procedure

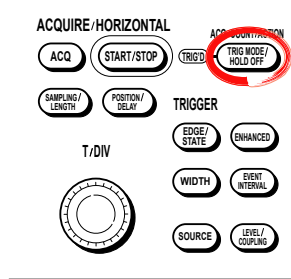

1. Press **TRIG MODE/HOLD OFF**. The Trigger Mode menu appears.
2. Press the soft key corresponding to the desired mode.

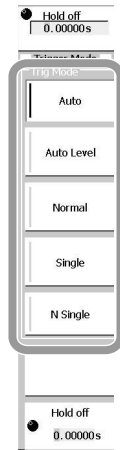

### Explanation

#### Auto Mode

If the trigger condition is met within the 100 ms timeout period, the waveform is updated on each trigger occurrence. If the trigger condition is not met after the timeout period elapses, the waveform is automatically updated. If the time axis setting is in the range in which the display mode is set to roll mode, the display is set to roll mode (see page 2-6).

#### Auto Level Mode

If a trigger occurs within the timeout period, the waveform is displayed in the same fashion as in auto mode. If a trigger is not activated within the timeout period, then the center value of the amplitude of the trigger source is detected, and the trigger level is changed to that value. A trigger is activated using the new value, and the displayed waveforms are updated. Auto-level mode is valid only if the trigger source is between CH1 and CH4. For all other cases, the operation is the same as for auto mode. If the time axis setting is in the range in which the display mode is set to roll mode, the display is set to roll mode.

#### Normal Mode

The display is updated only when the trigger conditions are met. The display is not updated if the trigger does not occur. Therefore, to check the waveform or ground level when no trigger is detected, use auto mode.

#### Single Mode

The display is updated once when the trigger conditions are met and the waveform acquisition stops. In the time axis setting range in which the display is set to roll mode, the display is set to roll mode. When a trigger occurs, the specified record length of data is acquired and the displayed waveform stops.

#### N Single Mode

When the trigger conditions are met, the display waveform is updated for the specified number of times, and then waveform acquisition is stopped.

#### Note

---

- The trigger mode setting is common to all triggers.
- The trigger conditions when the displayed waveform was acquired appear at the lower right of the screen.

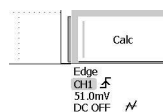

## 6.2 Setting the Trigger Type

### Procedure

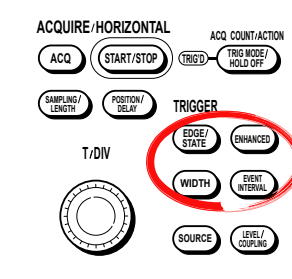

1. Press any of **EDGE/STATE**, **WIDTH**, **ENHANCED**, or **EVENT INTERVAL**. The key pressed lights, becoming active.

### For an Edge/State Trigger (See sections 6.7 to 6.10)

2. Press the soft key corresponding to the desired trigger type.

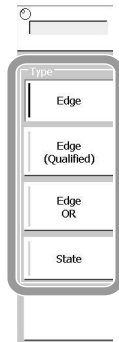

### For a Width Trigger (See sections 6.11 to 6.13)

2. Press the soft key corresponding to the desired trigger type.

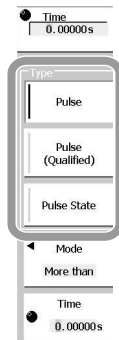

## 6.2 Setting the Trigger Type

**For an Enhanced Trigger (For details, see section 6.17 and subsequent sections).**

2. Press the **Type** soft key. The Type menu appears.
3. From the menu that appears, select the desired signal type.

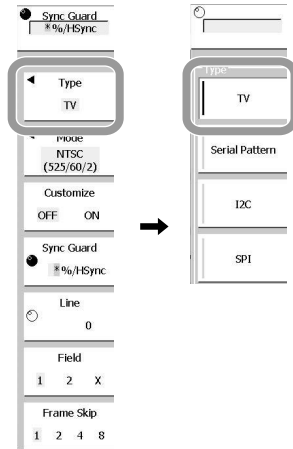

**For an EVENT Interval (See sections 6.14 to 6.16)**

2. Press the **Type** soft key. The Type menu appears.
3. Press the soft key corresponding to the desired trigger type.

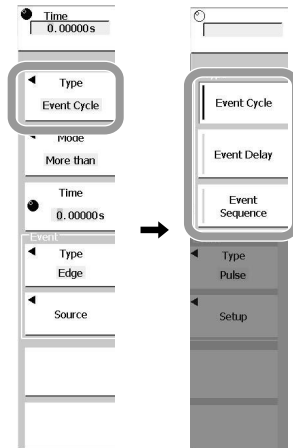

**Explanation****Edge/State Trigger**

There are four types of Edge/State triggers.

- **Edge trigger**

When the slope of the trigger source passes through the specified trigger level on a rising or falling edge, a trigger is activated. You can select the trigger source from input signals, the external trigger signal, and the commercial power supplied to the DL9000. In the case of commercial power, a trigger is activated only on the rising edge.

- **Edge (Qualified) Trigger**

While the state of each input channel satisfies the set qualify condition, this function activates a trigger on the edge of a single trigger source.

- **State trigger**

This function activates a trigger in either of the following circumstances.

- When the state condition is met or ceases to be met.
- The DL9000 checks the state condition at the rising or falling edge of the specified signal (clock signal) and normalizes the result (high if the state condition is met or low if not). A trigger is activated when the normalized condition changes.

- **Edge OR Trigger**

This function activates a trigger on the edge of multiple trigger sources.

**Width**

This function activates a trigger according to the time width. The following three triggers are available for Width.

- **Pulse trigger**

This function activates a trigger according to the relationship between the pulse width of a single trigger source and the specified time.

- End point of a pulse longer than the specified time (More than)
- End point of a pulse shorter than the specified time (Less than)
- End point of a pulse longer than the specified time T1 and shorter than the specified time T2 (Between)
- End point of a pulse shorter than the specified time T1 and longer than the specified time T2 (Out of range)
- Trigger when the pulse width exceeds the specified time (Time out)

- **Pulse (Qualified) Trigger**

While the state of each input channel satisfies the set qualify condition, this function activates a trigger according to the relationship between the pulse width of a single trigger source and the specified time. The timing at which a trigger is activated is the same as for a Pulse trigger.



## 6.2 Setting the Trigger Type

---

- **Pulse State trigger**

This function activates a trigger in either of the following circumstances.

- When the time during which the state condition is met or not met satisfies the relationship with the specified determination time.
- The DL9710L checks and normalizes the state condition on the rising or falling edge of the specified signal (clock source). A trigger is activated when the time during which the normalized condition is met or not met first satisfies the relationship with the specified time.

### **Enhanced**

This groups allows you to set triggers on special signals such TV triggers and serial pattern triggers. For details, see section 6.17 and subsequent sections.

### **Event Interval**

Taking a trigger condition, excluding an OR trigger or TV trigger, as an event, the trigger is activated when the event period, or the interval between two events meets preset time conditions. The time condition is the same as the time condition for the Width trigger.

- **Cycle**

Apply the trigger based on the relation between the event period and the specified time.

- **Delay**

Apply the trigger based on the relation between the time interval between event 1 occurring and the first occurrence of event 2 and the specified time.

If the time interval between event 1 occurring and the first occurrence of event 2 does not meet the specified time condition, then the decision is restarted the next time that event 1 occurs.

- **Sequence**

Apply the trigger based on the relation between the time interval between event 1 occurring and the first occurrence of event 2 and the specified time.

If the time interval between event 1 occurring and the first occurrence of event 2 does not meet the specified time condition, the occurrence of event 2 is ignored, and the trigger is activated when event 2 occurs to meet the specified time condition.

## 6.3 Setting Trigger Coupling/HF Rejection/Trigger Hysteresis/Window Comparator

### Procedure

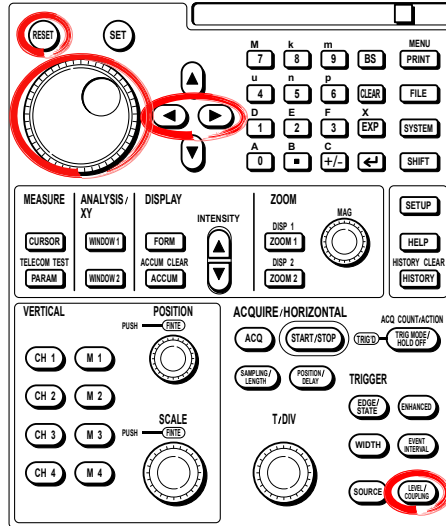

#### Setting the Trigger Coupling

1. Press **LEVEL/COUPLING**.
2. Press the **CH** soft key. A menu used to select the target channel appears.
3. Select the channel from among **CH1** to **CH4** and **EXT**, and press the corresponding soft key.  
If you select EXT, proceed to step 10.
4. Press the **Coupling** soft key to select DC or AC.

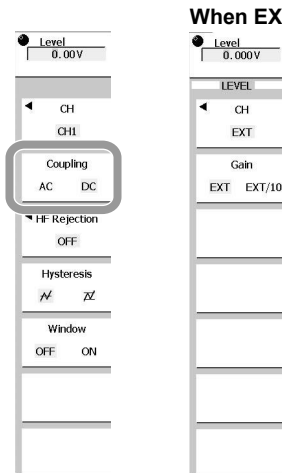

#### Note

The trigger coupling setting is common to all triggers. The trigger coupling setting is common to all triggers. However, in the case of TV trigger, this is fixed at TV.

### 6.3 Setting Trigger Coupling/HF Rejection/Trigger Hysteresis/Window Comparator

---

#### Setting the HF Rejection

5. Press the **HF Rejection** soft key. The HF Rejection menu is displayed.
6. Press the soft key corresponding to the desired frequency.

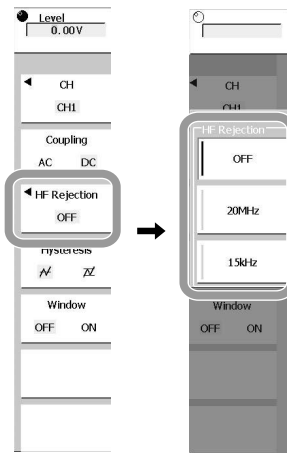

#### Note

---

The HF rejection setting is common to all triggers. However, for TV trigger this is fixed at 300 kHz.

---

#### Setting the Hysteresis

7. Press the **Hysteresis** soft key to select  $\nabla$  or  $\nabla$ .

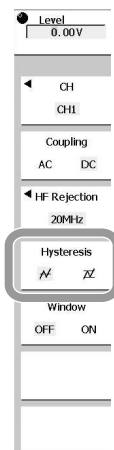

#### Note

---

The hysteresis setting is common to all triggers.

---

### 6.3 Setting Trigger Coupling/HF Rejection/Trigger Hysteresis/Window Comparator

#### Setting the Window Comparator

- Press the **Window** soft key to turn on the Window function. The soft key that is used to set the window appears.
- Using the **rotary knob**, set the center voltage and the voltage.  
Press the Center/Width soft key to toggle between the Center (window center level) and Width (window width) settings.  
You can use the arrow keys to move the digit that is currently being set.  
Pressing RESET when the trigger coupling is DC changes the window comparator to the current offset value.  
When the trigger coupling is AC, the window comparator is set to 0 V.

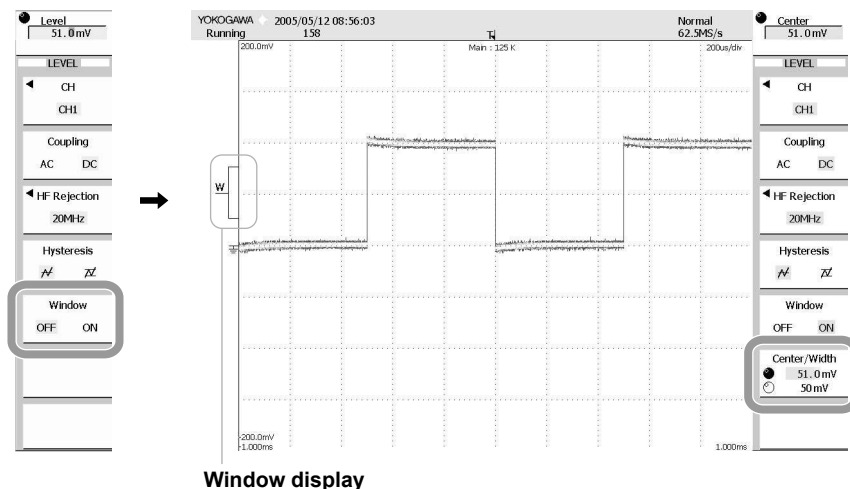

Window display

#### Note

The window comparator setting is common to all triggers.

#### Setting the Attenuation (for EXT)

- Press the **Gain** soft key and then select either EXT or EXT/10.

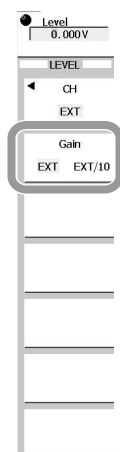

### 6.3 Setting Trigger Coupling/HF Rejection/Trigger Hysteresis/Window Comparator

#### Explanation

#### Trigger Coupling

You can select the trigger coupling.

---

AC	Uses a signal that is obtained by removing the DC component from the trigger source signal.
DC	Uses the trigger source signal as-is.

---

#### Note

- When using the TV trigger, this setting is fixed to TV.
  - When the trigger source is EXT, this setting is fixed to DC.
- 

#### HF Rejection

Specify 15 kHz or 20 MHz if you wish to use a signal that is obtained by removing the high frequency components (frequency components greater than 15 kHz or 20 MHz) from the trigger source signal as the trigger source.



#### Note

- This setting is not available when the trigger source is EXT.
  - When using the TV trigger, this setting is fixed to 300 kHz.
- 

#### Hysteresis

Sets a width to the trigger level so that triggers are not activated by small changes in the trigger signal.

---

	Approximately 0.3 division* of hysteresis around the trigger level.
	Approximately 1 division* of hysteresis around the trigger level.

---

\* The value above is an approximate value. It is not strictly warranted.

#### Window Comparator

Determines on whether the trigger condition or qualify/state condition that was being determined using the rising/falling edge or high/low level of the waveform is in or out of the specified range (window).

The Window comparator can be enabled or disabled separately for each channel. The trigger conditions, etc., change according to the Window comparator settings of the channel set for the trigger source, etc.

For example, if Window comparator is enabled for an edge-triggered source channel, the trigger can be activated according to whether the waveform on the source channel is inside or outside the set area.

The setting range and resolution are as follows:

---

Setup Item	Range	Resolution
Center	±4 div from the center of the screen	0.01 divisions
Width	±4 div around the center	0.02 divisions

---

## 6.4 Setting the Hold Off Time

### Procedure

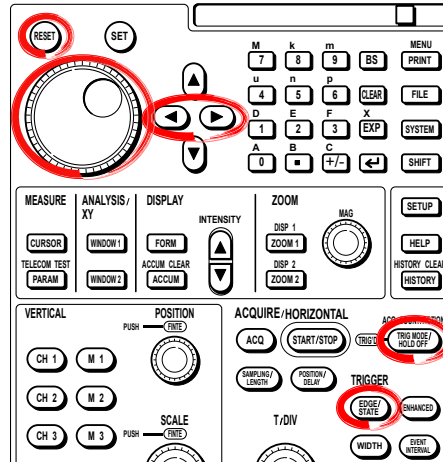

### Edge Trigger

1. Press **TRIG MODE/HOLD OFF**. The Trigger Mode menu appears.
2. Press the **Hold Off** soft key, and set the rotary knob target to Hold off.
3. Turn the **rotary knob** to set the hold off time.

You can use the arrow keys to move the digit that is currently being set.

Press **RESET** to reset the hold off time to 20 ns. (Use the arrow keys to change the selected digit until ns appears.)

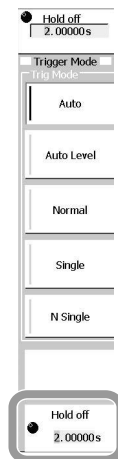

## 6.4 Setting the Hold Off Time

---

### Explanation

As shown in the figure below, this setting prevents a trigger from being activated for a specified time, even when the trigger conditions are met during this time. This is useful when you wish to activate the trigger in sync with a periodic signal.

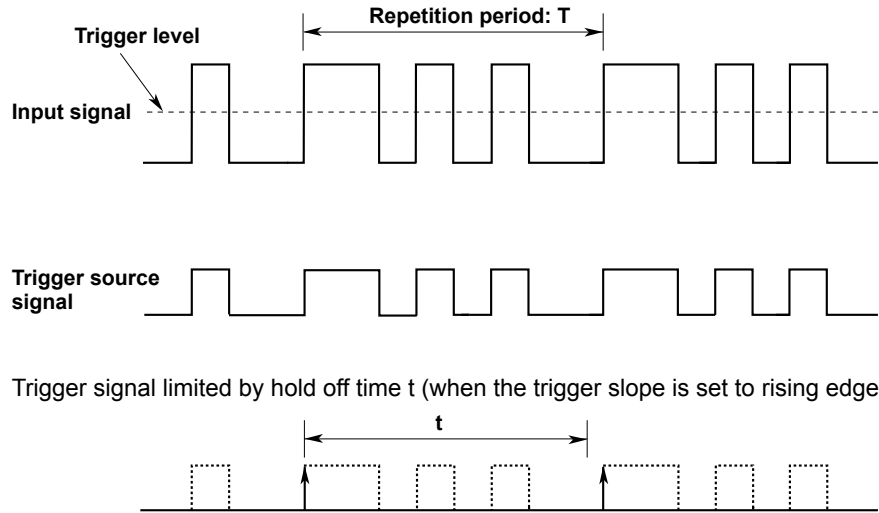

### Selectable Range of the Hold Off Time

The selectable range is 20 ns to 10.0000 s (the default value is 20 ns), and the resolution is 5 ns.

### Note

- The updating of the waveform may slow down when using repetitive sampling. In such case, set the hold off time to a smaller value.
  - If you are setting the hold off time to 100 ms or greater, set the trigger mode to normal.
-

## 6.5 Setting the Trigger Delay

### Procedure

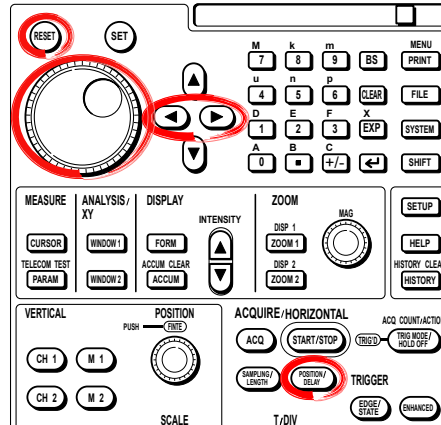

1. Press **POSITION/DELAY**. The Position/Delay menu appears.
2. Press the **Trigger Delay** soft key to turn the trigger delay on.
3. Press the **Delay Type** soft key.
4. Press the soft key for the delay type to be set.

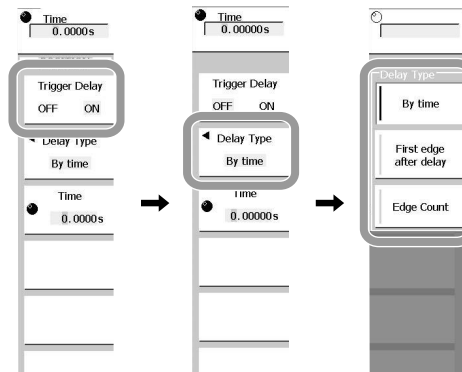

### Setting the Delay Time (By time, First edge after delay)

When By time or First edge after delay is set, set the delay time.

5. Press the **TIME** soft key.
6. Turn the **rotary knob** to set the delay.  
You can use the arrow keys to move the digit that is currently being set.  
Pressing **RESET** resets the value to 0 s.

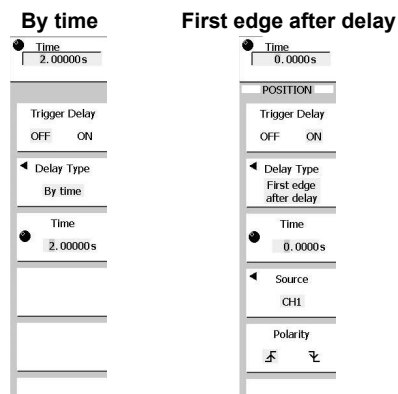



## 6.5 Setting the Trigger Delay

### Setting Count (Edge Count)

When Edge Count has been set, set Count.

7. Press the **Count** soft key.
8. Turn the **rotary knob** to set Count.

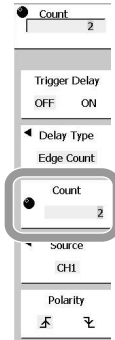

### Setting the Source (First edge after delay, Edge Count)

When First edge after delay or Edge count is set, set the source.

9. Press the **Source** soft key.
10. Press the soft key corresponding to the channel to be set.

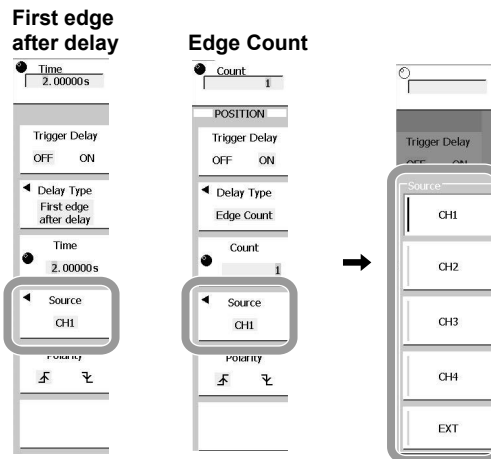

### Selecting Rising Edge/Falling Edge (First edge after delay, Edge Count)

When First edge after delay or Edge Count has been set, select rising edge/falling edge.

11. Press the **Polarity** soft key to select  $\uparrow$  or  $\downarrow$ .

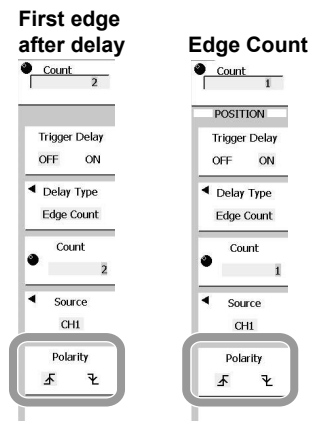

**Explanation**

Although the display usually shows the waveform before and after the trigger point, it is possible to display the acquired waveform after a fixed time period elapses using the trigger delay.

**Delay Type**

The following three delays are available for the delay type:

By time: Delay until the set time after the trigger condition is met.

First edge after delay: Delay until the first specified edge after the set time after the trigger condition is met.

Edge Count: Delay for the specified number of occurrences of the specified edge after the trigger condition is met.

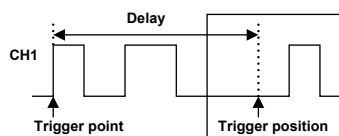

(1) By time

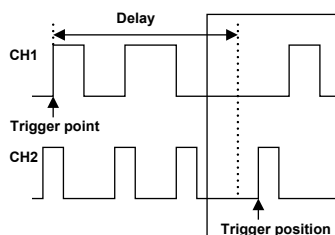

(2) First edge after delay

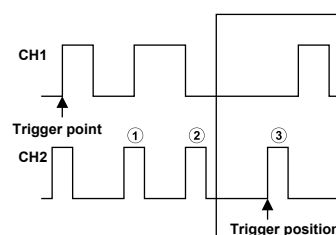

(3) Edge Count (when the trigger edge count is 3)

**Selectable Range of Delay**

Delay Type	Item	Resolution
By time	0 to 10 s	5 ps
First edge after delay	0 to 10 s	2 ns
Edge Count	1 to 10 <sup>9</sup>	1 step

**Note**

When T/div is changed, the delay remains unchanged.

**Level, Coupling, HF Rejection, Hysteresis, Window Comparator**

The level, coupling, HF rejection, hysteresis and window comparator settings for a First edge after delay or Edge Count source channel are as described in section 6.3.

## 6.6 Setting the Trigger Position

### Procedure

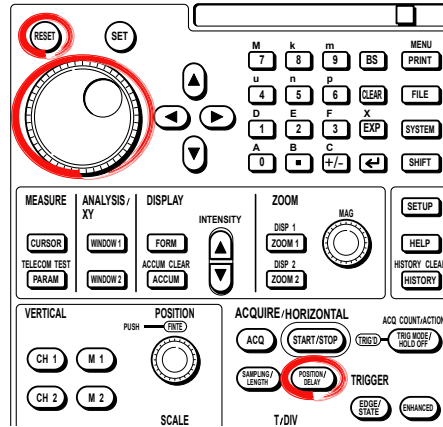

1. Press **POSITION/DELAY**. The Position/Delay menu appears.
2. Press the **Position** soft key.
3. Turn the **rotary knob** to set the trigger position.  
Pressing **RESET** resets the number to 50%.

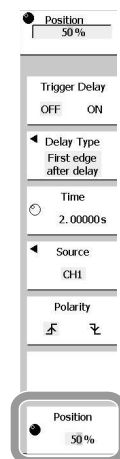

**Explanation****Trigger Position**

**Trigger position = Trigger point + Trigger delay**

You can select the location of the trigger position on the screen.

If the trigger delay is 0 s, the trigger position and the trigger point match. For the operating procedure of the trigger delay (see section 6.5).

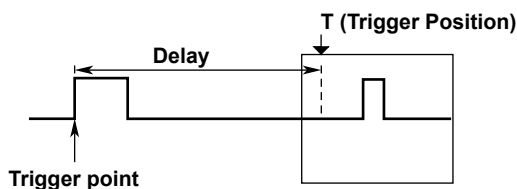
**Selectable Range of Trigger Position**

The trigger position can be set in the range of 0 to 100% (resolution is 1%) taking the display record length (see appendix 1) to be 100%.

**Displaying the Trigger Position**

A  $\nabla$  mark that appears at the top of the screen indicates the trigger position with respect to the display record length.

**Note**

- If you change the trigger position while waveform acquisition is stopped, the new setting will not become effective until acquisition is started and the waveform is updated.
- Note that cursor time measurements are with respect to the trigger position. Changing the trigger position therefore changes the measurement values (except when in roll mode display).
- If you change the T/div setting, the time axis setting is rescaled with respect to the trigger position.

## 6.7 Activating an Edge Trigger (Edge/State)

### Procedure

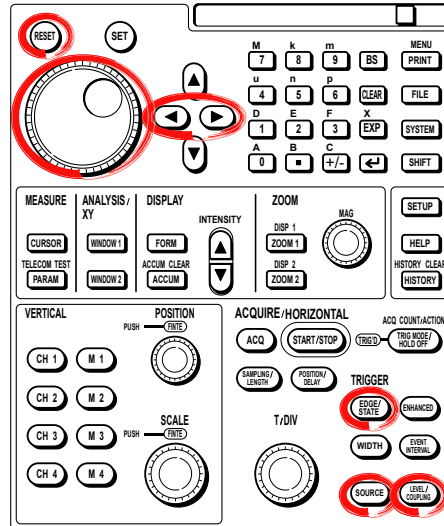

### Setting the Trigger Type

1. Press **EDGE/STATE**. The Type menu appears.
2. Press the **Edge** soft key.

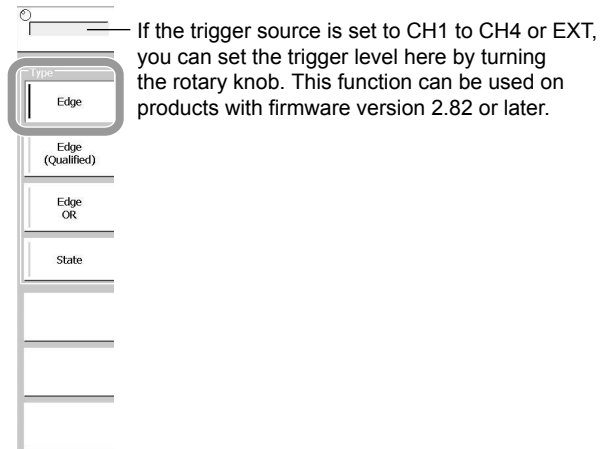

### Setting the Trigger Source (When the Trigger Source is CH1 to CH4 or EXT)

3. Press **SOURCE**. The Source menu appears.
4. Press the soft key corresponding to the desired trigger source.  
Select EXT to use an external signal to activate a trigger, and select LINE to use this unit's power supply signal to activate a trigger.

The following settings are necessary in order to use an external signal to activate a trigger.

- Trigger Level
- Trigger Slope
- Probe Attenuation
- Hold off time
- Window comparator (when necessary)

The following settings are necessary in order to use the commercial power supply to activate a trigger.

- Hold off time

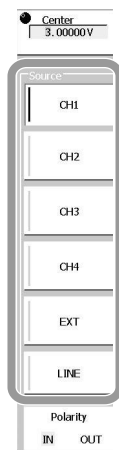

### Setting the Trigger Slope (When the Trigger Source is CH1 to CH4 or EXT)

5. Press the **Polarity** soft key to select  $\uparrow$  or  $\downarrow$ .  
If a channel for which window comparator has been set as the trigger source is specified, select either Enter or Exit.

#### Window comparator: OFF

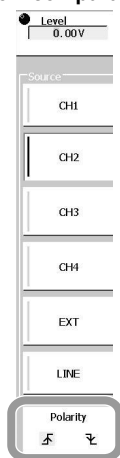

#### Window comparator: ON

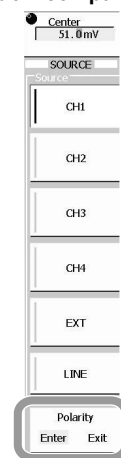

## 6.7 Activating an Edge Trigger (Edge/State)

### Setting the Trigger Level (When the Trigger Source is CH1 to CH4 or EXT)

6. Press **LEVEL/COUPLING**.
7. Turn the **rotary knob** to set the trigger level.  
You can use the arrow keys to change the digit that is currently being set.  
Pressing **RESET** resets the trigger level to the current offset voltage.  
When window comparator is **ON**, the window center position setting is used.

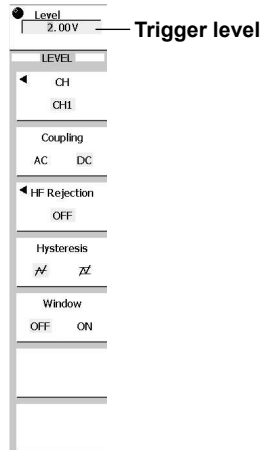

### Setting the Attenuation (When the Trigger Source Is EXT)

8. Press the **CH** soft key. A menu used to select the target appears.
9. Press the **EXT** soft key.
10. Press the **Gain** soft key and then select either **EXT** or **EXT/10**.

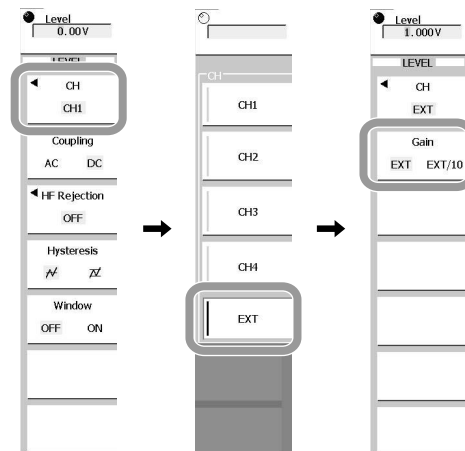

### Setting Trigger Coupling (When the Trigger Source is CH1 to CH4)

11. Set trigger coupling as described in section 6.3.

### Setting HF Rejection (When the Trigger Source is CH1 to CH4)

12. Set HF rejection as described in section 6.3.

**Setting Trigger Hysteresis (When the Trigger Source is CH1 to CH4)**

13. Set trigger hysteresis as described in section 6.3.

**Setting Window Comparator**

14. Set window comparator as described in section 6.3.

When window comparator is ON, the trigger is activated when the trigger signal enters or leaves the specified voltage range.

**Setting the Hold Off**

15. Set hold off as described in section 6.4.

**Explanation**

This setting is used to activate a trigger when the input signal of a specified channel crosses the trigger level.

**Trigger Source**

Select from among CH1 to CH4, EXT or LINE.

**Activating a Trigger with an External Signal**



When using an external signal that is input to the TRIG IN terminal on the rear panel for the trigger source, set the trigger source to EXT.

**Activating a Trigger with Commercial Power**

When activating a trigger with the commercial power that is used to power this unit, set the trigger source to LINE.

**Trigger Slope**

You can select how the trigger source signal is to cross the trigger level in activating the trigger.

	Activated when the trigger source changes from below the trigger level to above the trigger level (rising).
	Activated when the trigger source changes from above the trigger level to below the trigger level (falling).

Enter Trigger when the trigger source level enters the set voltage range  
(When window comparator is ON)

Exit Trigger when the trigger source level leaves the set voltage range  
(When window comparator is ON)

**Trigger Level**

- The selectable range is 8 divisions within the screen. The resolution is 0.01 divisions. For example, the resolution for 2 mV/div is 0.02 mV.
- You can also press the RESET key to reset the trigger level to the current offset voltage.

**Hold Off**

See section 6.4.



## 6.8 Activating a Qualified Edge Trigger (Edge/State)

### Procedure

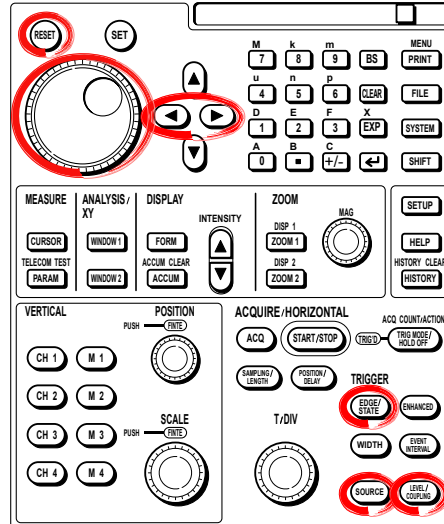

#### Setting the Trigger Type

1. Press **EDGE/STATE**.
2. Press the **Edge (Qualified)** soft key.

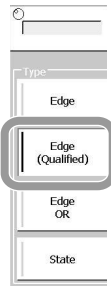

#### Setting the Trigger Source

3. Press **SOURCE**.
4. Press the **Source** soft key.
5. Press the soft key corresponding to the desired channel.

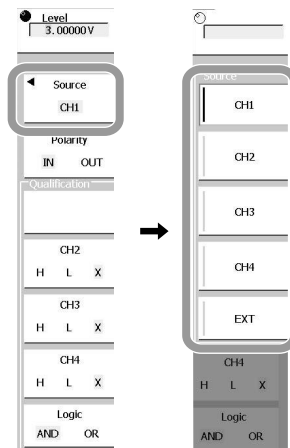

**Setting the Trigger Slope**

6. Press the **Polarity** soft key to select  $\uparrow$  or  $\downarrow$ .  
If a channel for which window comparator has been set as the trigger source is specified, select either Enter or Exit.

**Window comparator: OFF**

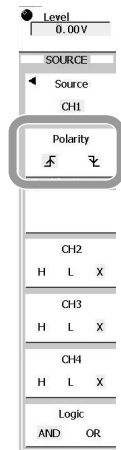

**Window comparator: ON**

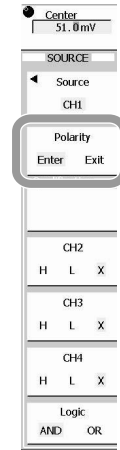

**Setting the Qualify Condition Status**

7. Press the soft key for the channel to be set and then select either H, L or X.

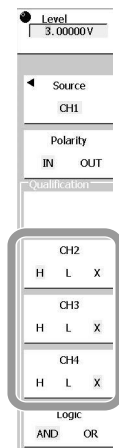

**Setting the Qualify Condition Logic**

8. Press the **Logic** soft key to select AND or OR.

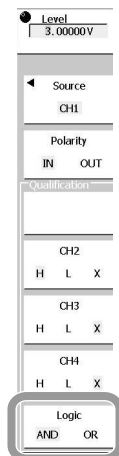

## 6.8 Activating a Qualified Edge Trigger (Edge/State)

### Setting the Trigger Level (When the Trigger Source is CH1 to CH4 or EXT)

9. Press **LEVEL/COUPLING**.
10. Turn the **rotary knob** to set the trigger level.
  - You can use the arrow keys to change the digit that is currently being set.
  - Pressing **RESET** resets the trigger level to the current offset voltage.
  - When window comparator is **ON**, the window center position setting is used.

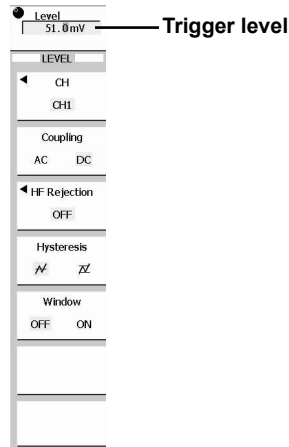

### Setting Trigger Coupling (When the Trigger Source is CH1 to CH4)

11. Set trigger coupling as described in section 6.3.

### Setting HF Rejection (When the Trigger Source is CH1 to CH4)

12. Set HF rejection as described in section 6.3.

### Setting Trigger Hysteresis (When the Trigger Source is CH1 to CH4)

13. Set trigger hysteresis as described in section 6.3.

### Setting the Window Comparator (When the Trigger Source is CH1 to CH4 or EXT)

14. Set window comparator as described in section 6.3.
  - When window comparator is **ON**, the trigger is activated when the trigger signal enters or leaves the specified voltage range.

### Setting the Hold Off (When the Trigger Source is CH1 to CH4 or EXT)

15. Set the hold off time as described in section 6.4.

**Explanation**

This specification is used to activate the edge trigger of a single trigger source when the input signal level of the specified channel meets the set condition.

**Trigger Source**

Select from among CH1 to CH4, or EXT.

**Activating a Trigger with an External Signal**

In order to use an external signal that is input to the TRIG IN terminal on the rear panel for the trigger source, set the trigger source to EXT.

**Trigger Level, Threshold Level**

- The selectable range is 8 divisions within the screen. The resolution is 0.01 divisions. For example, the resolution for 2 mV/div is 0.02 mV.
- You can also press the RESET key to reset the trigger level to the current offset voltage.

**Trigger Slope**

You can select how the trigger source signal is to cross the trigger level in activating the trigger.

⤴ Activated when the trigger source changes from below the trigger level to above the trigger level (rising).

⤵ Activated when the trigger source changes from above the trigger level to below the trigger level (falling).

Enter Trigger when the trigger source level enters the set voltage range (When window comparator is ON)

Exit Trigger when the trigger source level leaves the set voltage range (When window comparator is ON)

**Trigger delay**

See section 6.5.

**Qualify Condition**

Sets the condition that enables a trigger with the channel state.

State: CH1 = H, CH2 = L, AND, Trigger source: CH3, More than  
L: low level, H: high level

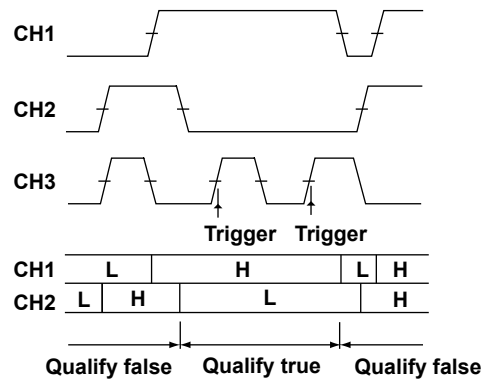

**Note**

The Qualify condition cannot be set for the source channel.

## 6.9 Activating a Trigger with the State Condition (Edge/State)

### Procedure

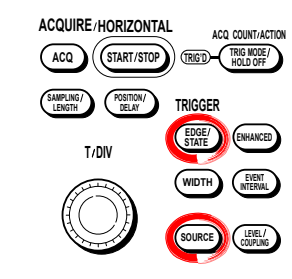

### Setting the Trigger Type

1. Press **EDGE/STATE**.
2. Press the **State** soft key.

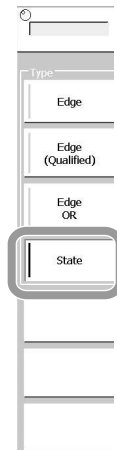

### Setting the Clock Channel

3. Press **SOURCE**.
4. Press the **Clock** soft key. The clock menu appears.
5. Press the soft key corresponding to the desired channel.

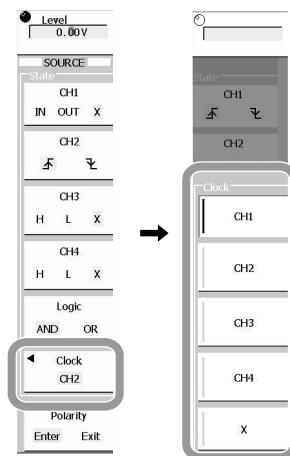

**Setting the State Condition**

- Press the soft key for each channel to be set and then select either H, L or X. For channels for which the Window comparator is ON, select one of IN, OUT, and X. For the channel selected to be the clock channel, select  $\uparrow$  or  $\downarrow$ . If the Window comparator is ON for the clock channel, select either Enter or Exit.

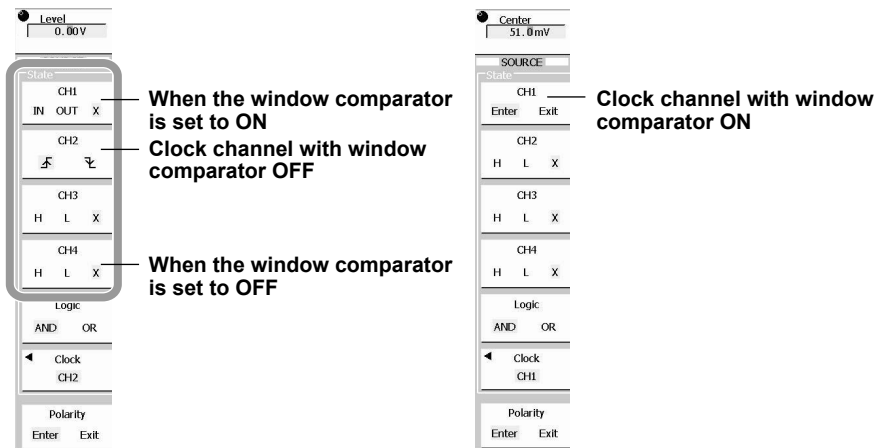

## 6.9 Activating a Trigger with the State Condition (Edge/State)

---

### Setting Logical AND or Logical OR

7. Press the **Logic** soft key to select AND or OR.

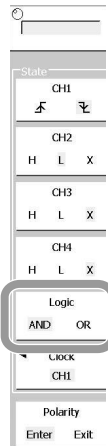

### Setting the Condition

8. Press the **Polarity** soft key to select Enter or Exit.

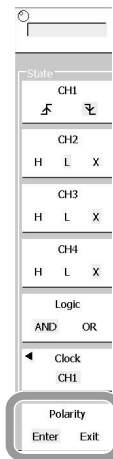

### Setting the Trigger Coupling

9. Set trigger coupling as described in section 6.3.

### Setting the HF Rejection

10. Set HF rejection as described in section 6.3.

### Setting the Hysteresis

11. Set trigger hysteresis as described in section 6.3.

### Setting the Window Comparator

12. Set window comparator as described in section 6.3.

### Setting the Hold Off

13. Set the hold off time as described in section 6.4.

**Explanation**

This function activates a trigger in either of the following circumstances:

- When the state condition is met or ceases to be met.
- The DL9000 checks the state condition at the rising or falling edge of the specified channel (clock channel) and normalizes the result (high if the state condition is met or low if not). A trigger is activated when the normalized condition changes.

**Trigger Source**

Select from among CH1 to CH4.

**State Condition**

Sets the state of each channel.

**Trigger delay**

Set the trigger delay as described in section 6.5.

**Clock Channel**

When no clock channel is specified, the trigger is activated by just the State condition. If a clock channel is specified, the trigger is activated according to the relationship of the rising edge or falling edge of the clock channel and the set State condition.

**Polarity**

Sets the state of the normalized condition in which the trigger is activated.

Enter: When the normalized condition changes from not met to met.

Exit: When the normalized condition changes from met to not met.

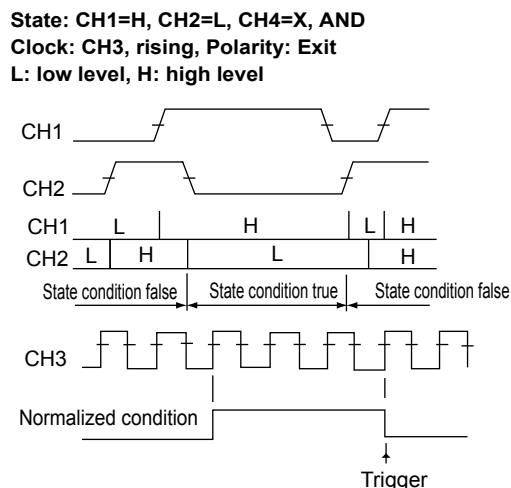
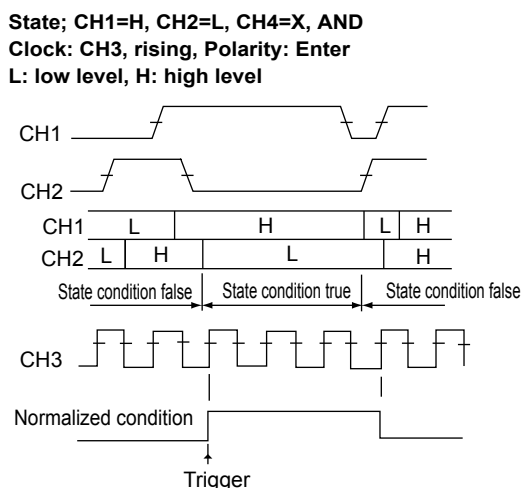
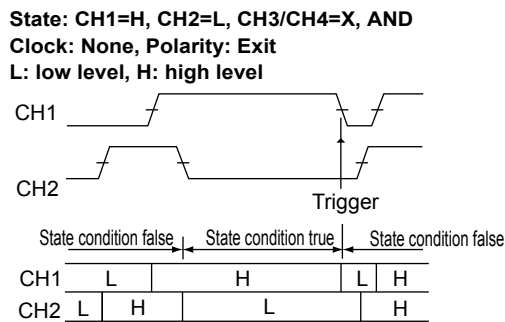
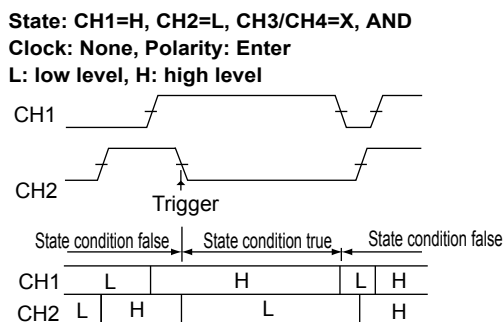



## 6.10 Activating a Trigger by ORing Multiple Edge Triggers (Edge/State)

### Procedure

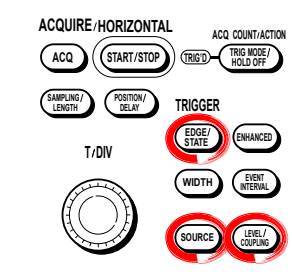

### Setting the Trigger Type

1. Press **EDGE/STATE**.
2. Press the **Edge OR** soft key.

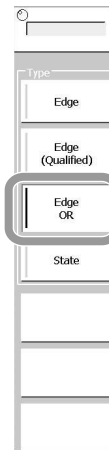

### Setting the Trigger Slope

3. Press **SOURCE**.
4. Press the soft key for the channel to be set and then select either  $\uparrow$ ,  $\downarrow$  or X. For channels with the Window comparator set to ON, select either Enter, Exit, or X.

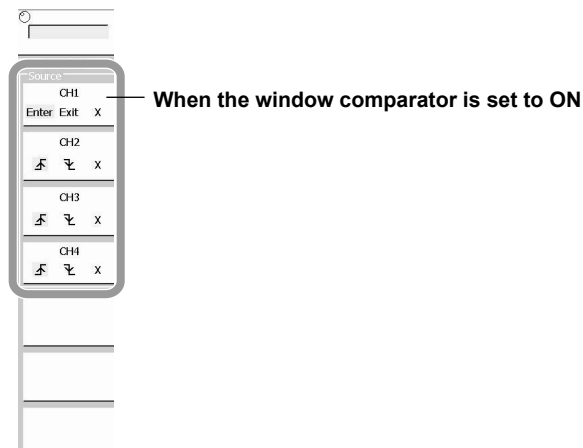

### Setting the Trigger Level

5. Press **LEVEL/COUPLING**.
6. Press the **CH** soft key.
7. Press the soft key corresponding to the desired channel.

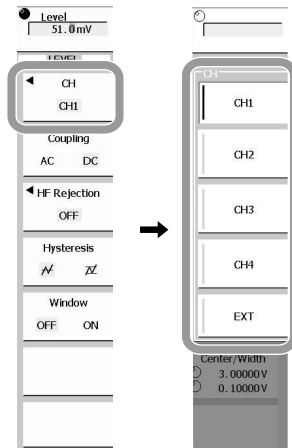

### Setting the Trigger Coupling

8. Set trigger coupling as described in section 6.3.

### Setting the HF Rejection

9. Set HF rejection as described in section 6.3.

### Setting the Hysteresis

10. Set hysteresis as described in section 6.3.

### Setting the Window Comparator

11. Set window comparator as described in section 6.3.  
When window comparator is ON, the trigger is activated when the trigger signal enters or leaves the specified voltage range.

### Setting the Hold Off

12. Set the hold off time as described in section 6.4.

## 6.10 Activating a Trigger by ORing Multiple Edge Triggers (Edge/State)

---

### Explanation

This specification is used to activate a trigger on the edge of multiple trigger sources.

#### Trigger Source

Select from among CH1 to CH4.

#### Trigger Slope

You can select how the trigger source signal is to cross the trigger level in activating the trigger.

---

 Activated when the trigger source changes from below the trigger level to above the trigger level (rising).

---

 Activated when the trigger source changes from above the trigger level to below the trigger level (falling).

---

Enter Trigger when the trigger source level enters the set voltage range  
(When window comparator is ON)

---

Exit Trigger when the trigger source level leaves the set voltage range  
(When window comparator is ON)

---

X Don't care

---

#### Hold Off

See section 6.4.

## 6.11 Activating a Trigger by Pulse Width (Width)

### Procedure

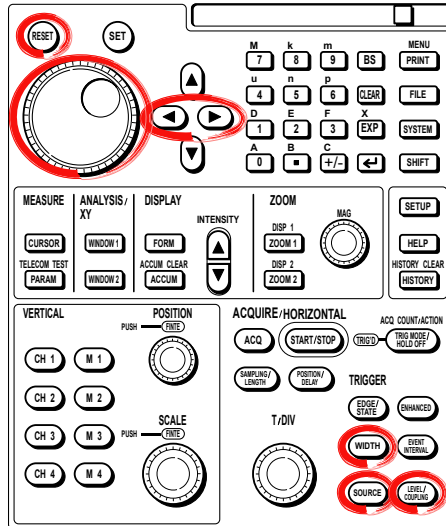

### Setting the Trigger Type

1. Press the **WIDTH**. The Type screen appears.
2. Press the **Pulse** soft key.

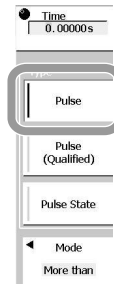

### Setting the Trigger Mode

3. Press the **Mode** soft key.
4. Press the soft key that corresponds to the desired mode: **More than**, **Less than**, **Between**, **Out of range**, or **Time Out**.

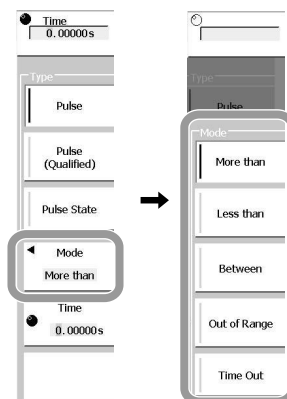

## 6.11 Activating a Trigger by Pulse Width (Width)

### Setting the Determination Time

5. Press **WIDTH**.
  6. Turn the **rotary knob** to set the determination time.
    - Pressing **RESET** resets the determination time to 1.0 ns.
    - You can use the arrow keys to move the digit that is currently being set.
- When the time mode is set to **Between** or **Out of Range**, make two time settings. Use the soft keys to switch which the rotary knob setting applies to.

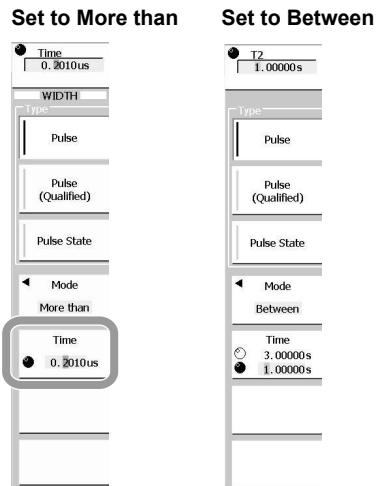

### Setting the Channel

7. Press **SOURCE**. The Source menu appears.
8. Press the soft key corresponding to the channel to be set.
9. Press the **Polarity** soft key to set the polarity of the pulse signal to either Pos [positive] or Neg [negative].
10. Press **ESC**. The Source menu closes.

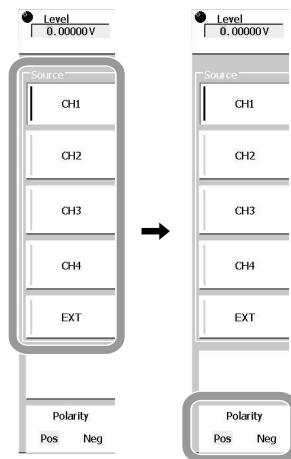

**Setting the Level, Hysteresis, Trigger Coupling, and HF Rejection**

11. Press **LEVEL/COUPLING**. The LEVEL menu appears.
12. Set the Level, Hysteresis, Trigger Coupling, and HF Rejection.  
When the Window comparator is ON, the trigger level setting is the setting of the center position of the window.  
For the setting procedure (see section 6.3).

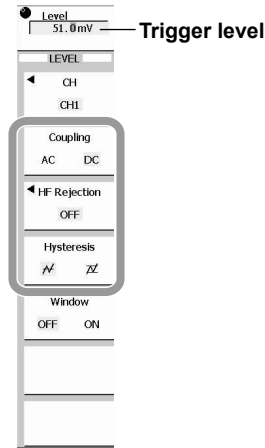

13. Press **ESC**. The Level/Coupling menu closes.

**Setting the Hold Off**

14. Set the hold off time according to the procedures given in section 6.4.

**Explanation**

This setting is for activating a trigger by determining whether the time over which the specified condition is met or not met is shorter or longer than the determination time set in advance.

**Pulse trigger**

This function activates a trigger according to the relationship between the pulse width of a single trigger source and the specified time.

More than	The trigger is activated when the pulse width is longer than the set determination time, and the state changes.
Less than	The trigger is activated when the pulse width is shorter than the set determination time, and the state changes.
Between	The trigger is activated when the pulse width is longer than T1, the first of the two set determination times, and shorter than T2, and the state changes.
Out of Range	The trigger is activated when the pulse width is shorter than T1, the first of the two set determination times, or longer than T2, and the state changes.
Time Out	The trigger is activated when the pulse width is longer than the set determination time.

## 6.11 Activating a Trigger by Pulse Width (Width)

### Example

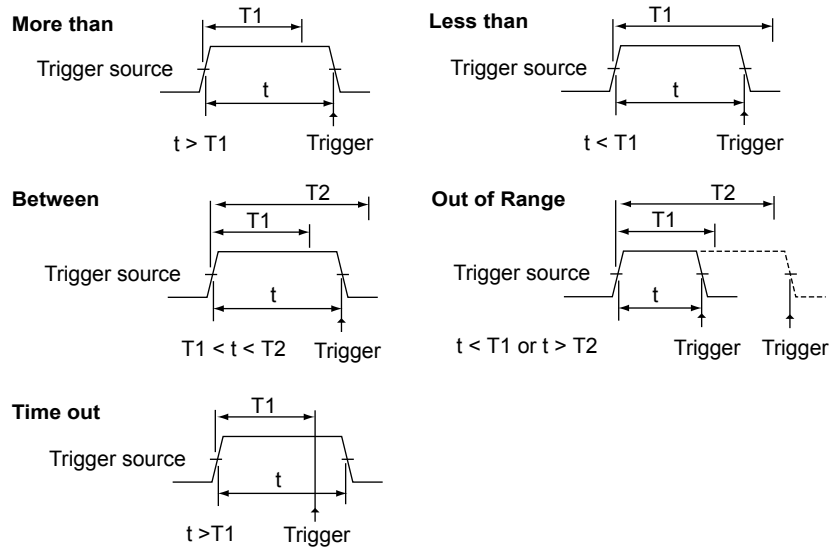

The point where the trigger occurs differs between More than and Time Out as shown in the figure below.

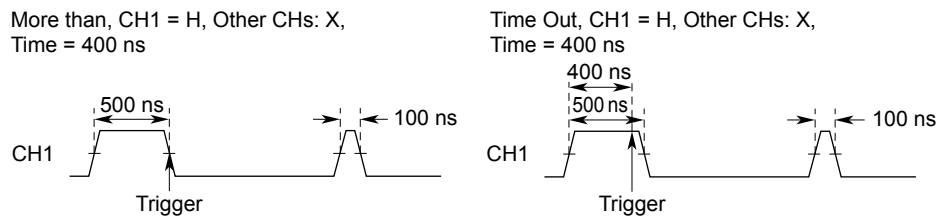

### Trigger Level

Item: 8 divisions on the screen

Resolution: 0.01 divisions

For example, the resolution for 2 mV/div is 0.02 mV.

### Hysteresis

Sets a width to the trigger level so that triggers are not activated by small changes in the trigger signal.

Approximately 0.3 division\* of hysteresis around the trigger level.

Approximately 1 division\* of hysteresis around the trigger level.

\* The value above is an approximate value. It is not strictly warranted.

### Trigger Coupling

You can select the trigger coupling.

AC Uses a signal that is obtained by removing the DC component from the trigger source signal.

DC Uses the trigger source signal as-is.

### Turning ON/OFF the HF Rejection

Specify 15 kHz or 20 MHz if you wish to use a signal that is obtained by removing the high frequency components (frequency components greater than 15 kHz or 20 MHz) from the trigger source signal as the trigger source.

### Determination Time

The selectable range is 1.0 ns to 10.0000 s, and the resolution is 0.5 ns.

### Relationship to the Window Comparator

When a channel with the Window comparator set to ON is selected for the source channel, the trigger can be activated either when the waveform is within the specified voltage range, or when the waveform is outside the specified voltage range.

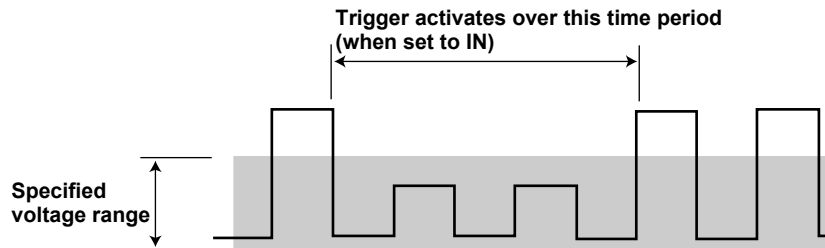

### Hold Off

See section 6.4.

### Note

The trigger may not operate correctly, if the interval between signals or the pulse width of the signal is less than 2 ns. The time accuracy of the pulse width under standard operating conditions after calibration is (0.2% of setting + 1 ns). However, the setting for  $T1 < \text{Pulse} < T2$  is the T2 value.



## 6.12 Activating a Trigger by Qualified Pulse Width (Width)

### Procedure

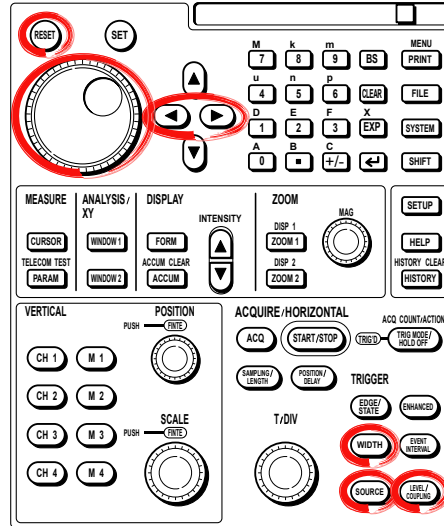

#### Setting the Trigger Type

1. Press the **WIDTH**. The Type screen appears.
2. Press the **Pulse (Qualified)** soft key.

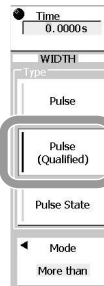

#### Setting the Trigger Mode

3. Press the **Mode** soft key.
4. Press the soft key that corresponds to the desired mode: **More than**, **Less than**, **Between**, **Out of range**, or **Time Out**.

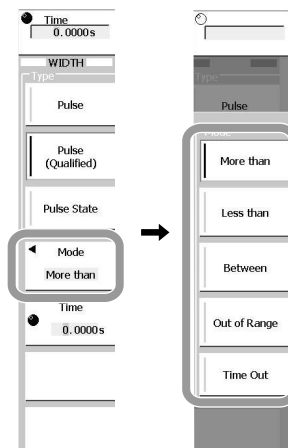

**Setting the Determination Time**

5. Turn the **rotary knob** to set the determination time.
  - Pressing RESET resets the determination time to 1.0 ns.
  - You can use the arrow keys to move the digit that is currently being set.
  - When the time mode is set to Between or Out of Range, make two time settings.
  - Use the soft keys to switch which the rotary knob setting applies to.

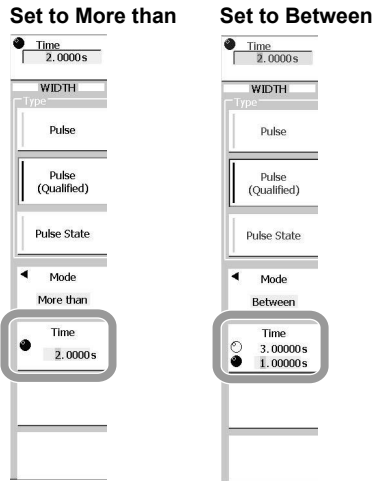

**Setting the Channel**

6. Press **SOURCE**. The SOURCE menu appears.
7. Press the **Source** soft key.
8. Press the soft key corresponding to the channel to be set.
9. Press the **Polarity** soft key to set the polarity of the pulse signal to either Pos [positive] or Neg [negative].  
If the window comparator is ON, select either IN or OUT.

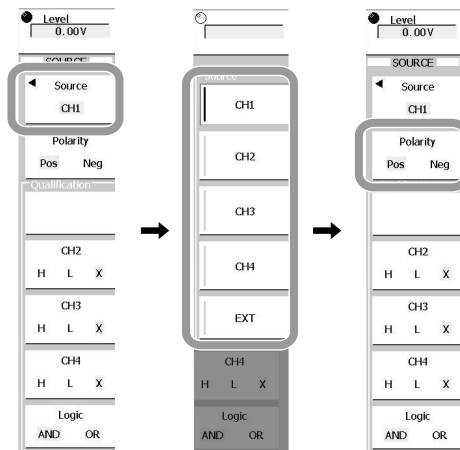

## 6.12 Activating a Trigger by Qualified Pulse Width (Width)

### Setting the Determination Conditions

10. Press the soft key for the channel to be set as a condition and then select H, L or X.  
If the window comparator is ON, select either IN, OUT or X.
11. Press the **Logic** soft key to select AND or OR.

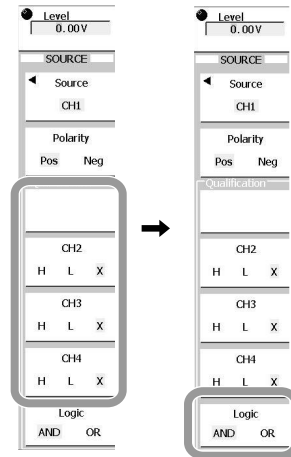

### Setting the Hysteresis, Trigger Coupling, and HF Rejection

12. Press **LEVEL/COUPLING**. The LEVEL menu appears.
13. Set the Hysteresis, Trigger Coupling, and HF Rejection.  
For the setting procedure (see section 6.3).
14. Press the **Window** soft key to select ON or OFF.
15. Press **ESC**. The LEVEL menu closes.

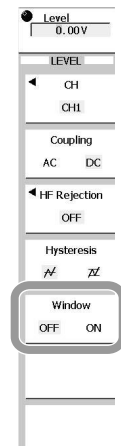

### Setting the Hold Off Time

16. Set the hold off time according to the procedures given in section 6.4.

**Explanation**

A trigger is activated by the relationship between the pulse width of a single trigger source and the specified time while the status of each input channel satisfies the set qualify conditions. The timing at which a trigger is activated is the same as for Pulse.

**Example**

State: CH1 = H, CH2 = L, AND, Trigger source: CH3, More than  
L: low level, H: high level

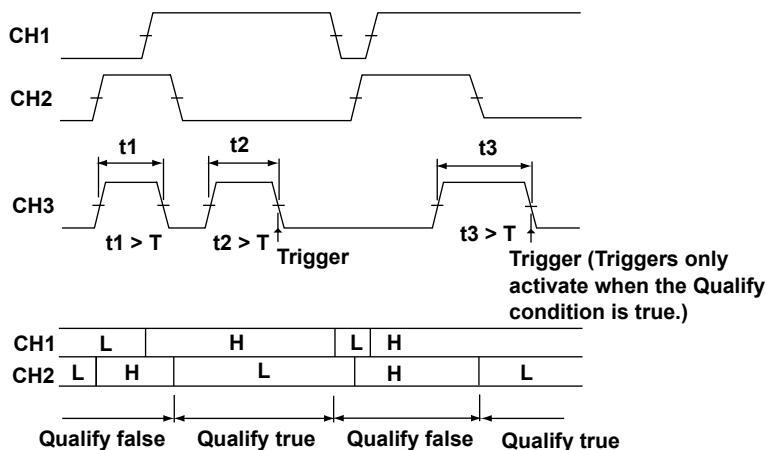
**Trigger Level**

Item: 8 divisions on the screen

Resolution: 0.01 divisions

For example, the resolution for 2 mV/div is 0.02 mV.

**Hysteresis**

Sets a width to the trigger level so that triggers are not activated by small changes in the trigger signal.

 Approximately 0.3 division\* of hysteresis around the trigger level.

 Approximately 1 division\* of hysteresis around the trigger level.

\* The value above is an approximate value. It is not strictly warranted.

**Trigger Coupling**

You can select the trigger coupling.

AC Uses a signal that is obtained by removing the DC component from the trigger source signal.

DC Uses the trigger source signal as-is.

**Turning ON/OFF the HF Rejection**

Specify 15 kHz or 20 MHz if you wish to use a signal that is obtained by removing the high frequency components (frequency components greater than 15 kHz or 20 MHz) from the trigger source signal as the trigger source.

**Determination Time**

The selectable range is 1.0 ns to 10.0000 s, and the resolution is 0.5 ns.

## 6.12 Activating a Trigger by Qualified Pulse Width (Width)

---

### Relationship to the Window Comparator

When a channel with the Window comparator set to ON is selected for the source channel, the trigger can be activated either when the waveform is within the specified voltage range, or when the waveform is outside the specified voltage range.

### Hold Off

See section 6.4.

### **Note**

---

The trigger may not operate correctly, if the interval between signals or the pulse width of the signal is less than 2 ns. The time accuracy of the pulse width under standard operating conditions after calibration is  $\pm(0.2\% \text{ of setting} + 1 \text{ ns})$ . However, the setting for  $T1 < \text{Pulse} < T2$  is the  $T2$  value.

---

## 6.13 Activating a Trigger by Width During Which a State Condition Is True (Width)

### Procedure

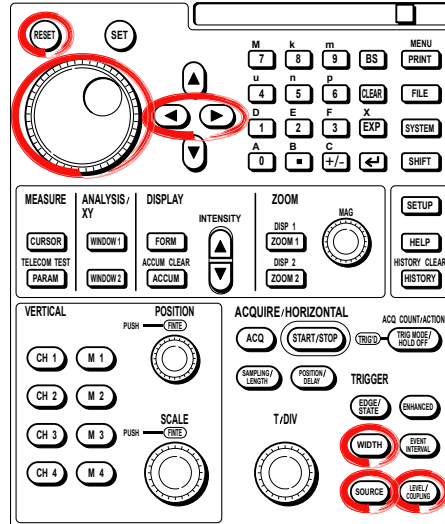

#### Setting the Trigger Type

1. Press **WIDTH**.
2. Press the **Pulse State** soft key.

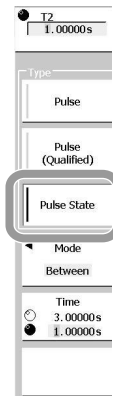

#### Setting the Mode

3. Press the **Mode** soft key.
4. Press the soft key corresponding to the channel to be set.

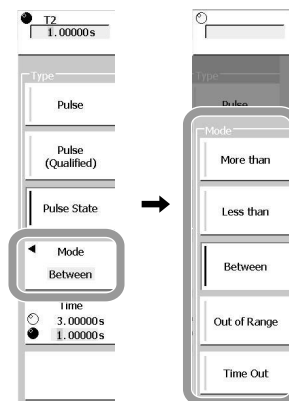

## 6.13 Activating a Trigger by Width During Which a State Condition Is True (Width)

### Setting the Determination Time

5. Press the **Time** soft key and set the rotary knob target to Time.
6. Turn the **rotary knob** to set the determination time.

Pressing RESET resets the determination time to 1.0 ns.

You can use the arrow keys to move the digit that is currently being set.

When the time mode is set to Between or Out of Range, make two time settings.

Use the soft keys to switch which the rotary knob setting applies to.

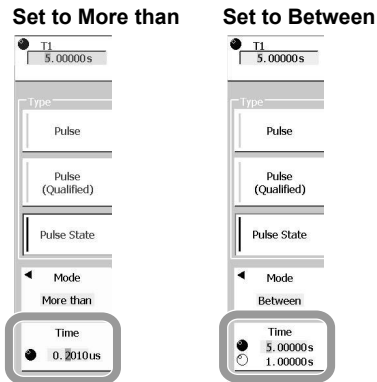

### Setting the Clock Channel

7. Press **SOURCE**.
8. Press the **Clock** soft key. The clock menu appears.
9. Press the soft key corresponding to the desired channel.

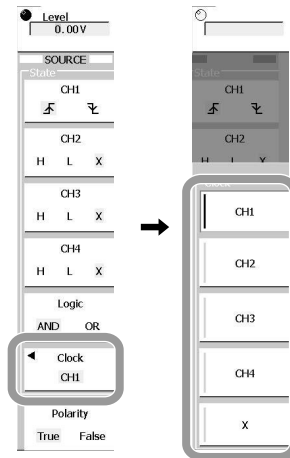

## 6.13 Activating a Trigger by Width During Which a State Condition Is True (Width)

### Setting the State Condition

10. Press the soft key for each channel to be set and then select either H, L or X.  
If the window comparator is ON either IN, OUT, or X.  
For the channel selected to be the clock channel, select  $\uparrow$  or  $\downarrow$ .  
If the Window comparator is ON for the clock channel, select either Enter or Exit.

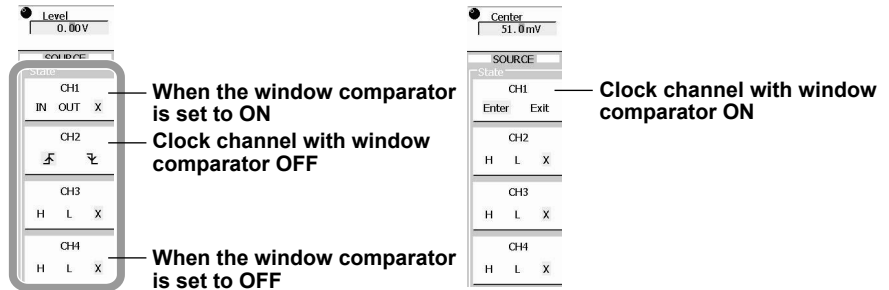

### Setting Logical AND or Logical OR

11. Press the **Logic** soft key to select AND or OR.

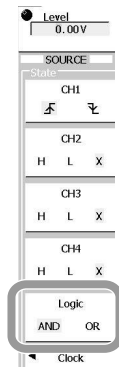

### Setting the Condition

12. Press the **Polarity** soft key to select True or False.

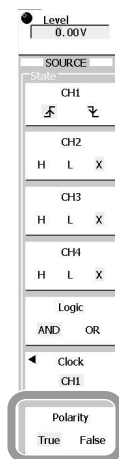



## 6.13 Activating a Trigger by Width During Which a State Condition Is True (Width)

### Setting Level, Hysteresis, Trigger Coupling and HF Rejection

13. Press **LEVEL/COUPLING**.
14. Set the Level, Hysteresis, Trigger Coupling, and HF Rejection.  
For the operation procedure (see section 6.3).

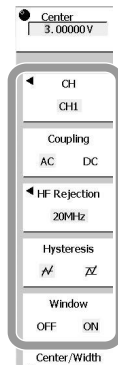

### Setting the Hold Off

15. Set the hold off time according to the procedures given in section 6.4.

## Explanation

This function activates a trigger in either of the following circumstances:

- When the time during which the state condition is met or not met satisfies the relationship with the specified determination time.
- The DL9000 checks and normalizes the state condition on the rising or falling edge of the specified channel (clock channel). A trigger is activated when the time during which the normalized condition is met or not met first satisfies the relationship with the specified time.

More than	A trigger is activated when the time during which the state condition is met or not met is longer than the specified determination time, and the state changes.
Less than	A trigger is activated when the time during which the state condition is met or not met is shorter than the specified determination time, and the state changes.
Between	A trigger is activated when the time during which the state condition is met or not met is longer than the specified determination time T1 and shorter than T2, and the state changes.
Out of Range	A trigger is activated when the time during which the state condition is met or not met is shorter than the specified determination time T1 or longer than T2, and the state changes.
Time Out	A trigger is activated when the time during which the state condition is met or not met is longer than the specified determination time.

## 6.13 Activating a Trigger by Width During Which a State Condition Is True (Width)

### Example

**State:** CH1 = H, CH2 = L, CH3/CH4 = X, AND  
**Clock:** None, **Polarity:** True, **More than**  
**L:** low level, **H:** high level

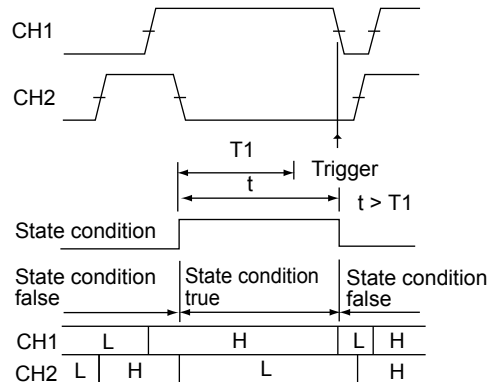

**State:** CH1 = H, CH2 = L, CH3/CH4 = X, AND  
**Clock:** None, **Polarity:** False, **More than**  
**L:** low level, **H:** high level

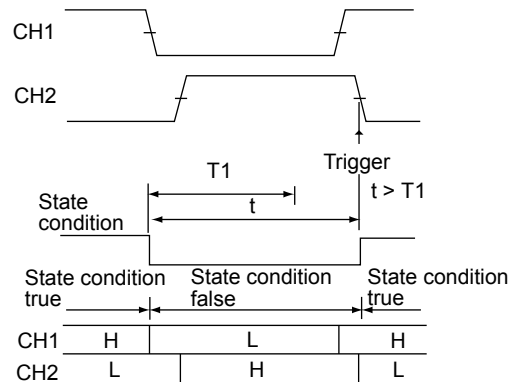

**State:** CH1 = H, CH2 = L, CH4 = X, AND  
**Clock:** CH3, rising, **Polarity:** True  
**L:** low level, **H:** high level

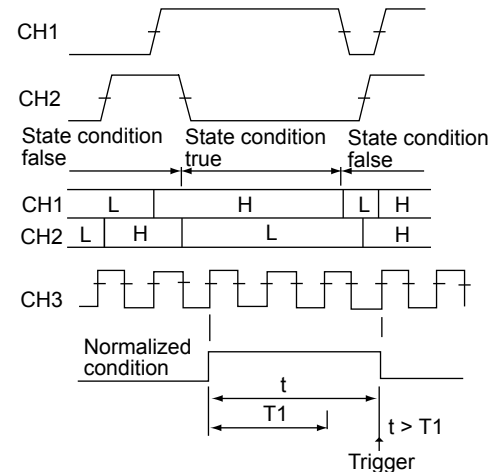

**State:** CH1 = H, CH2 = L, CH4 = X, AND  
**Clock:** CH3, rising, **Polarity:** False  
**L:** low level, **H:** high level

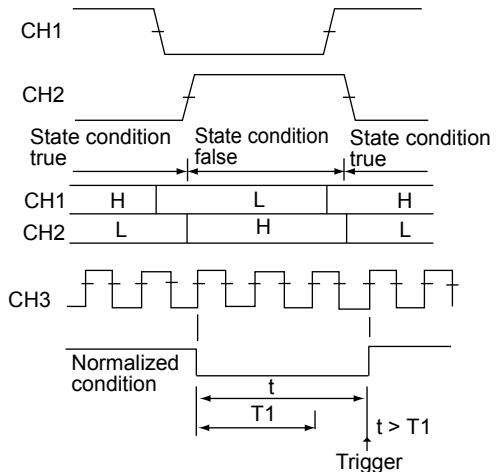

### Trigger Level

Range: 8 divisions on the screen

Resolution: 0.01 divisions

For example, the resolution for 2 mV/div is 0.02 mV.

### Hysteresis

Sets a width to the trigger level so that triggers are not activated by small changes in the trigger signal.

Approximately 0.3 division\* of hysteresis around the trigger level.

Approximately 1 division\* of hysteresis around the trigger level.

\* The value above is an approximate value. It is not strictly warranted.

### Trigger Coupling

You can select the trigger coupling.

AC Uses a signal that is obtained by removing the DC component from the trigger source signal.

DC Uses the trigger source signal as-is.

### 6.13 Activating a Trigger by Width During Which a State Condition Is True (Width)

---

#### Turning ON/OFF the HF Rejection

Specify 15 kHz or 20 MHz if you wish to use a signal that is obtained by removing the high frequency components (frequency components greater than 15 kHz or 20 MHz) from the trigger source signal as the trigger source.

#### Determination Time

The selectable range is 1.0 ns to 10.0000 s, and the resolution is 0.5 ns.

#### Relationship to the Window Comparator

When a channel with the Window comparator set to ON is selected for the source channel, the trigger can be activated either when the waveform is within the specified voltage range, or when the waveform is outside the specified voltage range.

#### Hold Off

See section 6.4.

#### **Note**

---

The trigger may not operate correctly, if the interval between signals or the pulse width of the signal is less than 2 ns. The time accuracy of the pulse width under standard operating conditions after calibration is  $\pm(0.2\%$  of setting + 1 ns). However, the setting for T1 < Pulse < T2 is the T2 value.

---

## 6.14 Activating a Trigger with the Event Cycle (Event Interval)

### Procedure

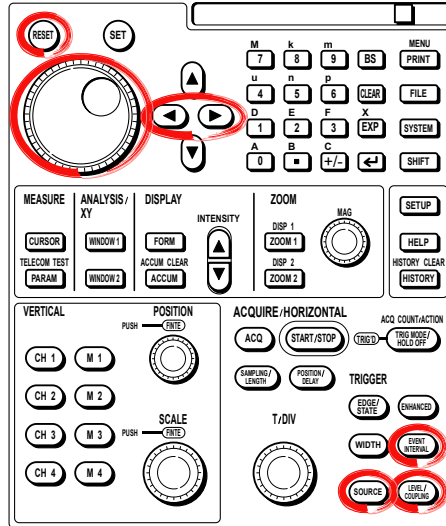

#### Setting the Trigger Type

1. Press **EVENT INTERVAL**.
2. Press the **Type** soft key.
3. Press the **Event Cycle** soft key.

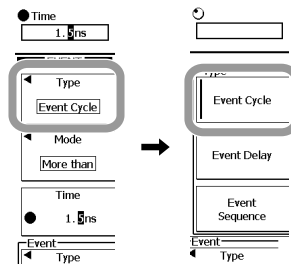

#### Setting the Mode

4. Press the **Mode** soft key.
5. Press the soft key corresponding to the channel to be set.

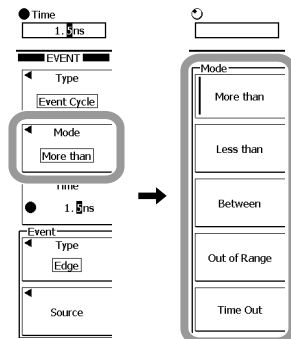

## 6.14 Activating a Trigger with the Event Cycle (Event Interval)

### Setting the Determination Time of the Event

- Turn the **rotary knob** to set the determination time.  
You can move between the digits using the arrow keys.  
Pressing RESET resets the determination time to 1.5 ns.  
If you set the time width mode to Between or Out of Range, set two time values.  
Press the soft key to switch the item to be changed using the rotary knob.

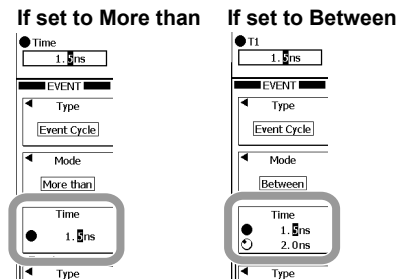

### Setting the Event Type

- Press the **Type** soft key.
- Press the soft key corresponding to the desired event type.  
For some event types, the menu may expand further in which case you will select the event type from the expanded menu.

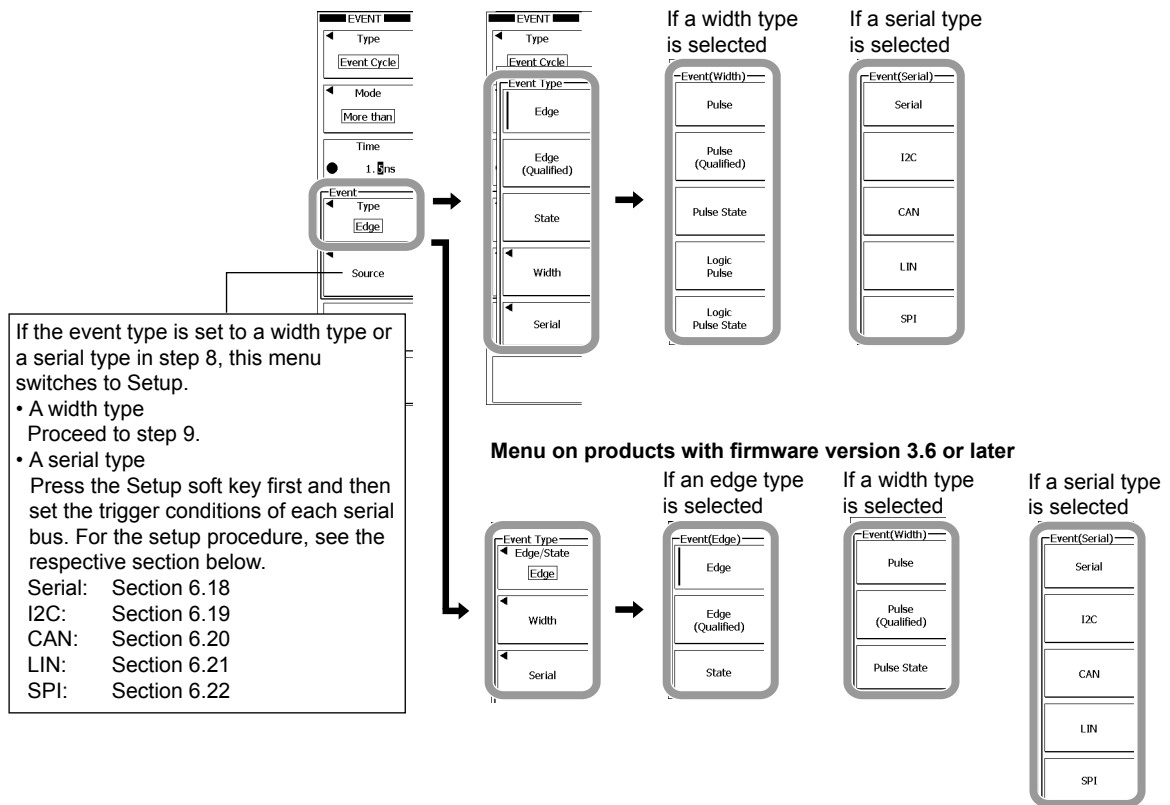

### Setting the Time Width Mode of the Pulse Width or the Width during Which the State Condition Is True (When the Event Type is a Width Type)

- Press the **Setup** soft key.
- Press the **Mode** soft key.
- Press the soft key corresponding to the desired mode.
- Set the determination time of the Width for the time width mode.
- Press **ESC** to return to the previous screen.

## 6.14 Activating a Trigger with the Event Cycle (Event Interval)

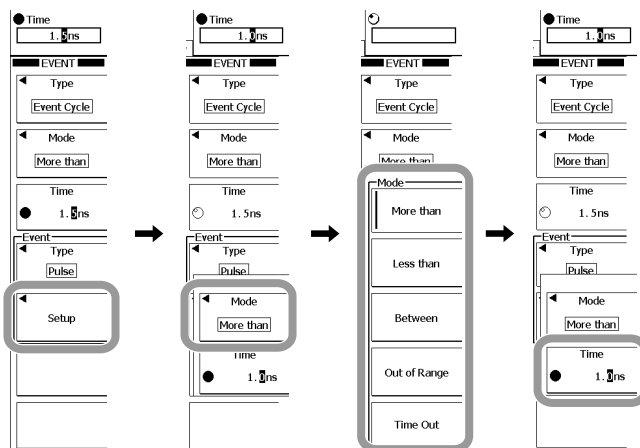

### Setting the Event Source

- If the event type is Edge, Edge(Qualified), or State press the **Source** soft key. The setup menu appears.

If the event type is a Width type or Serial type, press **SOURCE** on the front panel and press the **Setup** soft key in the menu that appears. You can also press **SOURCE** on the front panel and press the **Setup** soft key in the menu that appears if the event type is Edge, Edge(Qualified), or State.

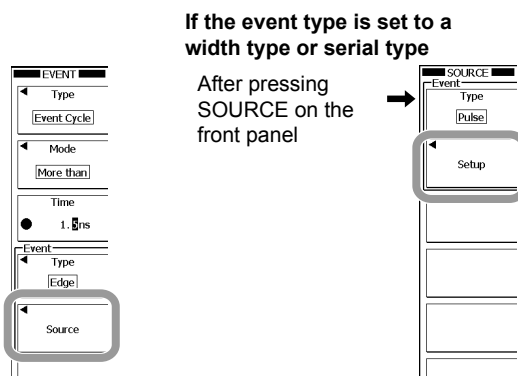

The subsequent operation varies depending on the event type. See the following sections for the trigger source settings.

Event Type	See Section:
Edge	Step 4 in section 6.7
Edge(Qualified)	Step 4 in section 6.8
State	Step 4 in section 6.9
Width type	
Pulse	Step 8 in section 6.11
Pulse(Qualified)	Step 8 in section 6.12
Pulse State	Step 8 in section 6.13
Serial type	
Serial	Step 9 in section 6.18
I2C	Step 30 in section 6.19
CAN	Step 34 in section 6.20
LIN	Step 7 in section 6.21
SPI	Step 17 in section 6.22

## 6.14 Activating a Trigger with the Event Cycle (Event Interval)

### Explanation

The trigger is activated when the event cycle based on a previously described trigger (except for the Edge OR trigger and TV trigger) meets the time condition that was set.

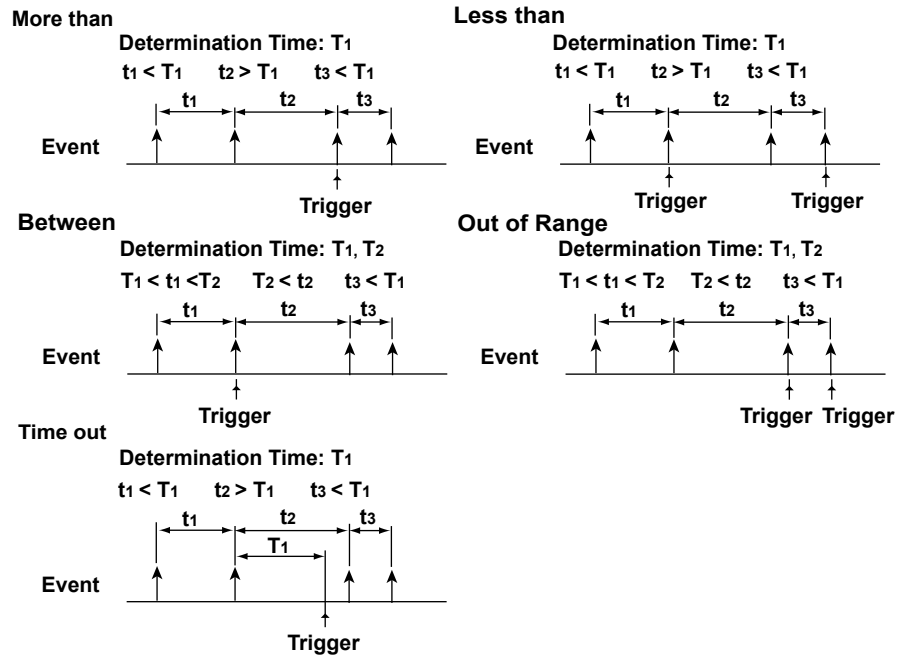

### Setting the Event Mode

More than	A trigger is activated at the end of a cycle longer than the specified time.
Less than	A trigger is activated at the end of a cycle shorter than the specified time.
Between	A trigger is activated at the end of a cycle that is longer than the specified time $T_1$ and shorter than the specified time $T_2$ .
Out of Range	A trigger is activated at the end of a cycle that is shorter than the specified time $T_1$ or longer than the specified time $T_2$ .
Time out	A trigger is activated when the cycle exceeds the specified time.

### Setting the Determination Time of the Event

The selectable range is 1.5 ns to 10.00 s, and the resolution is 0.5 ns.

#### Note

The trigger may not operate correctly, if the interval between signals or the pulse width of the signal is less than 2 ns. The time width accuracy under standard operating conditions after calibration is  $\pm(0.2\%$  of setting + 1 ns). However, the setting for  $T_1 < \text{Pulse} < T_2$  is the  $T_2$  value.

### Setting the Event Type

Set a trigger excluding Edge OR trigger and TV trigger as the event. For details, see the section for the respective trigger.

### Setting the Event Source

Set a trigger source excluding Edge OR trigger and TV trigger as the event source. For details, see the section for the respective trigger.

## 6.15 Activating a Trigger with the Event Delay (Event Interval)

### Procedure

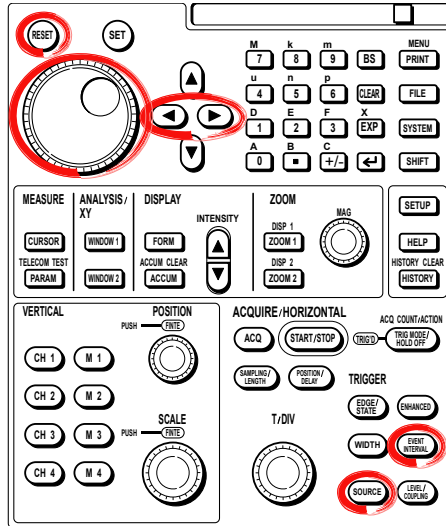

1. Press **EVENT INTERVAL**.
2. Press the **Type** soft key.
3. Press the **Event Delay** soft key.

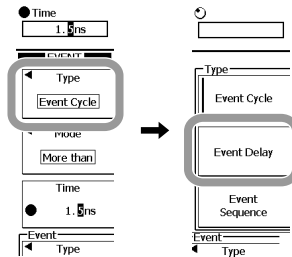



## 6.15 Activating a Trigger with the Event Delay (Event Interval)

### Setting the Event Mode and Try Mode

4. Press the **Mode** soft key.
5. Press the **More than**, **Less than**, **Between**, **Out of Range**, or **Time Out** soft key to set the mode.
6. Press the **Mode** soft key under Try Mode to select ON or OFF.
  - If you select ON, a trigger is activated on the first or second event that you select in the next step.
  - Select ON if you want to check whether a trigger is activated on the first or second event.
7. Press the **Event** soft key to select 1st or 2nd.
8. Press **ESC** to return to the previous screen.

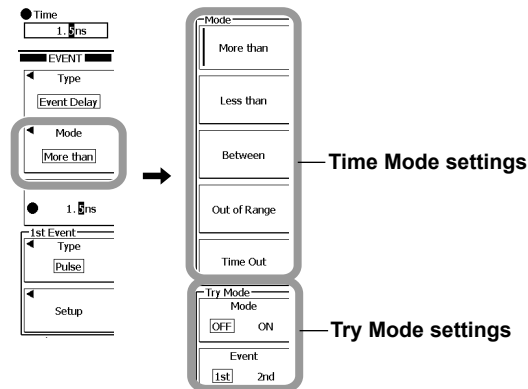

### Setting the Determination Time of the Event

9. Turn the **rotary knob** to set the determination time.
    - You can move between the digits using the arrow keys.
    - Press RESET to reset the determination time to 1.5 ns.
- If you set the time width mode to **Between** or **Out of Range**, set two time values. Press the soft key to switch the item to be changed using the rotary knob.

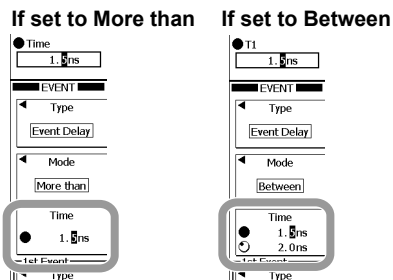

**Setting the Event Type**

10. Press the **Type** soft key under 1st Event or 2nd Event.
11. Press the soft key corresponding to the desired event type.
  - For some event types, the menu may expand further in which case you will select the event type from the expanded menu.

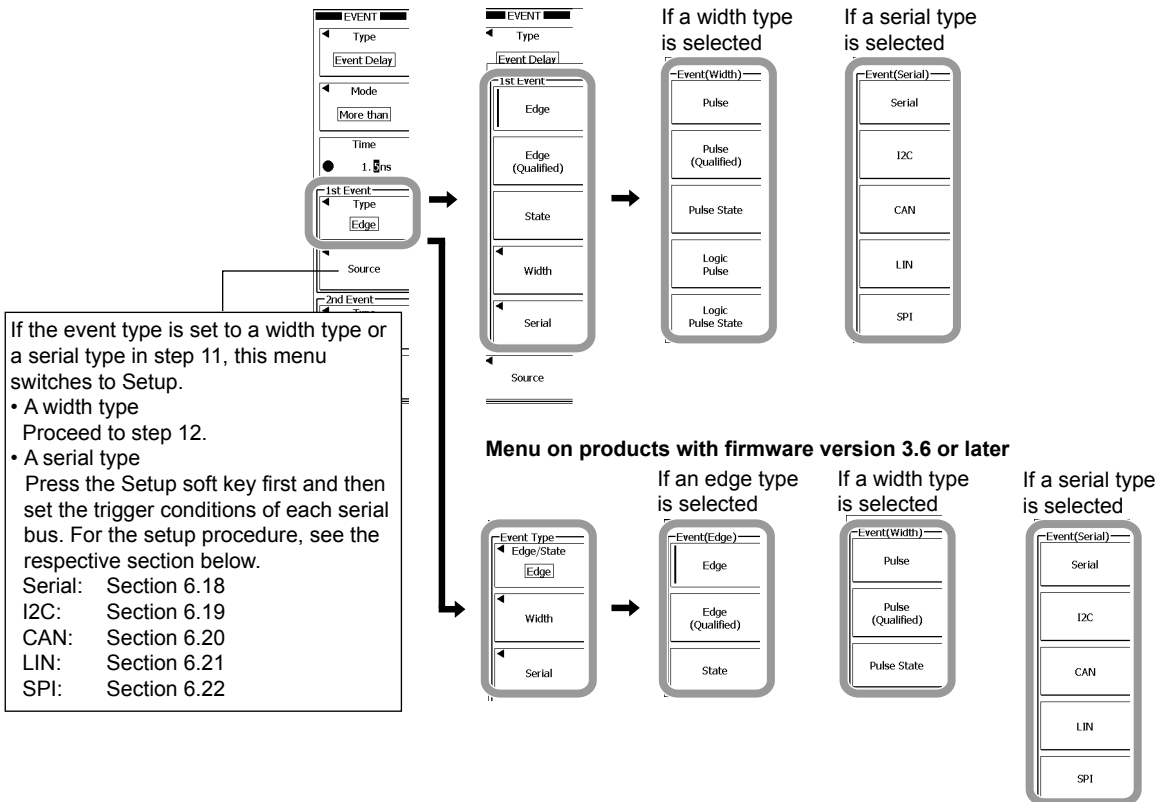

**Setting the Time Width Mode of the Pulse Width or the Width during Which the State Condition Is True (When the Event Type is a Width Type)**

12. Press the **Setup** soft key.
13. Press the **Mode** soft key.
14. Press the soft key corresponding to the desired mode.
15. Set the determination time of the Width for the time width mode.
16. Press **ESC** to return to the previous screen.

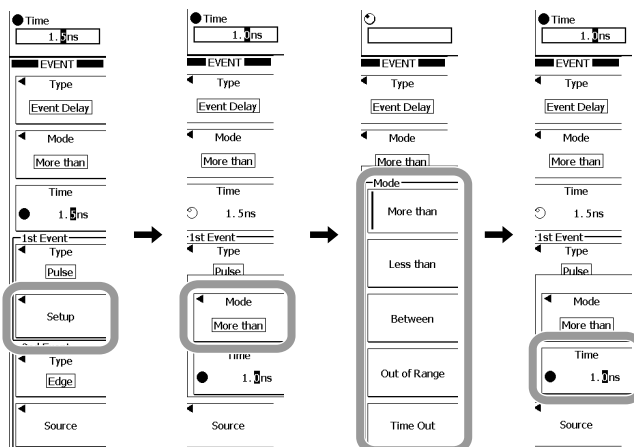

## 6.15 Activating a Trigger with the Event Delay (Event Interval)

### Setting the Event Source

17. If the event type is Edge, Edge(Qualified), or State press the **Source** soft key. The setup menu appears.

If the event type is a Width type or Serial type, press **SOURCE** on the front panel and press the **Setup** soft key in the menu that appears. You can also press **SOURCE** on the front panel and press the **Setup** soft key in the menu that appears if the event type is Edge, Edge(Qualified), or State.

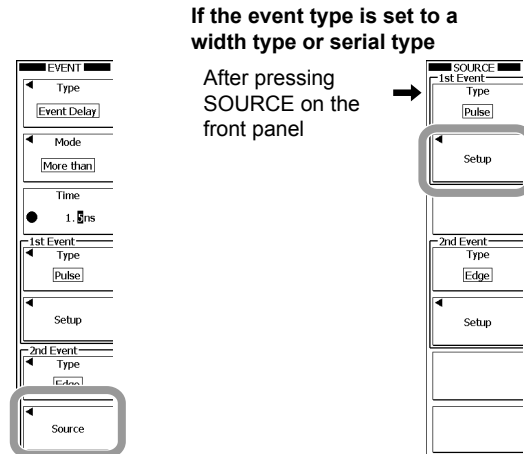

The subsequent operation varies depending on the event type. See the following sections for the trigger source settings.

Event Type		See Section:
Edge		Step 4 in section 6.7
Edge(Qualified)		Step 4 in section 6.8
State		Step 4 in section 6.9
Width type	Pulse	Step 8 in section 6.11
	Pulse(Qualified)	Step 8 in section 6.12
	Pulse State	Step 8 in section 6.13
Serial type	Serial	Step 9 in section 6.18
	I2C	Step 30 in section 6.19
	CAN	Step 34 in section 6.20
	LIN	Step 7 in section 6.21
	SPI	Step 17 in section 6.22

### Explanation

Normally, the waveform before and after the event is displayed, but if you want to monitor the waveform for a prescribed interval after the event occurs, set the event delay. The trigger is activated when the time interval from the point when event 1 occurs until the point when event 2 first occurs satisfies the time condition that was set. If the time interval from the point when event 1 occurs until the point when event 2 first occurs does not satisfy the time condition that was set before event 1 occurs again, a new determination is made starting from the point when event 1 occurred again.

The following example shows the case of “More Than.”

More than

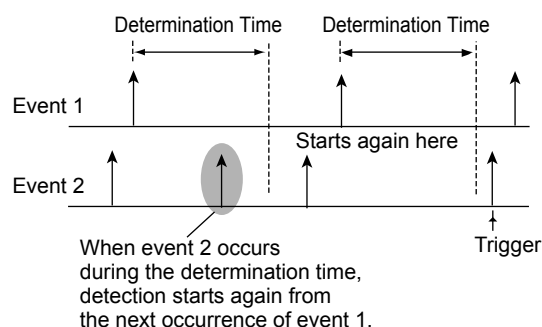

### Setting the Event Mode

More than	When the time interval from event 1 to event 2 is longer than the specified time, a trigger is activated at the event 2 occurrence.
Less than	When the time interval from event 1 to event 2 is shorter than the specified time, a trigger is activated at the event 2 occurrence.
Between	When the time interval from event 1 to event 2 is longer than the specified T1 time and shorter than the specified T2 time, a trigger is activated at the event 2 occurrence.
Out of Range	When the time interval from event 1 to event 2 is shorter than the specified T1 time or longer than the specified T2 time, a trigger is activated at the event 2 occurrence.
Time out	When the time interval from event 1 to event 2 is longer than the specified time, a trigger is activated the specified time after the event 1 occurrence.

### Setting the Try Mode

Turn this mode ON to check whether a trigger is activated by either of the events before the trigger is activated by the combination of the 1st event and the 2nd event.

### Setting the Determination Time of the Event

The selectable range is 1.5 ns to 10.00 s, and the resolution is 0.5 ns.

### Note

The trigger may not operate correctly if the interval between signals or the pulse width of the signal is less than 2 ns. The time width accuracy under standard operating conditions after calibration is  $\pm(0.2\% \text{ of setting} + 1 \text{ ns})$ . However, the setting for  $T1 < \text{Pulse} < T2$  is the  $T2$  value.

### Setting the Event Type

Set a trigger excluding Edge OR trigger and TV trigger as the event. For details, see the section for the respective trigger.

### Setting the Event Source

Set a trigger source excluding Edge OR trigger and TV trigger as the event source. For details, see the section for the respective trigger.

## 6.16 Activating a Trigger with the Event Sequence (Event Interval)

### Procedure

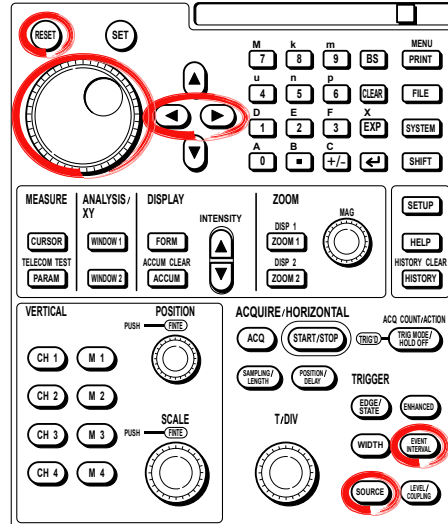

#### Selecting the Trigger Type

1. Press **EVENT INTERVAL**.
2. Press the **Type** soft key.
3. Press the **Event Sequence** key.

#### Setting the Event Mode and Try Mode

4. Press the **Mode** soft key.
5. Press the **More than**, **Less than**, **Between**, **Out of Range**, or **Time Out** soft key to set the mode.
6. Press the **Mode** soft key under Try Mode to select ON or OFF.  
If you select ON, a trigger is activated on the first or second event that you select in the next step.  
Select ON if you want to check whether a trigger is activated on the first or second event.
7. Press the **Event** soft key to select 1st or 2nd.
8. Press **ESC** to return to the previous screen.

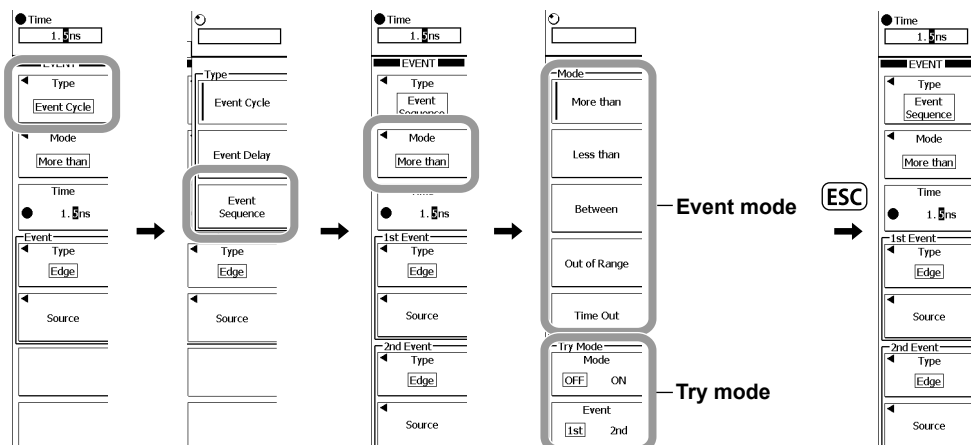

**Setting the Determination Time of the Event**

9. Turn the **rotary knob** to set the determination time.  
 You can move between the digits using the arrow keys.  
 Press RESET to reset the determination time to 1.5 ns.  
 If you set the time width mode to Between or Out of Range, set two time values.  
 Press the soft key to switch the item to be changed using the rotary knob.

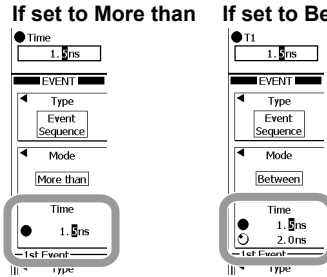

**Setting the Event Type**

10. Press the **Type** soft key for either 1st Event or 2nd Event.
11. Press the soft key corresponding to the type of event to be set.  
 For some event types, the menu may expand further in which case you will select the event type from the expanded menu.

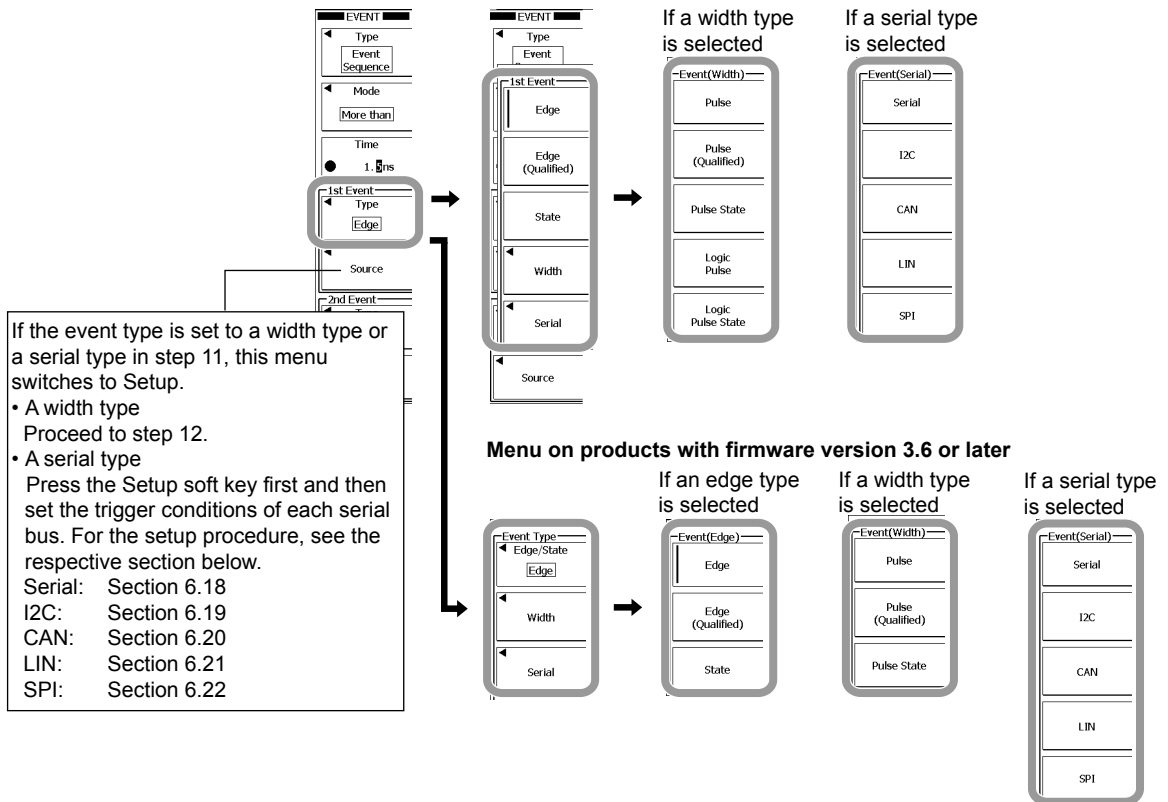

**Setting the Time Width Mode of the Pulse Width or the Width during Which the State Condition Is True (When the Event Type is a Width Type)**

12. Press the **Setup** soft key.
13. Press the **Mode** soft key.
14. Press the soft key corresponding to the desired mode.
15. Set the determination time of the Width for the time width mode.
16. Press **ESC** to return to the previous screen.

## 6.16 Activating a Trigger with the Event Sequence (Event Interval)

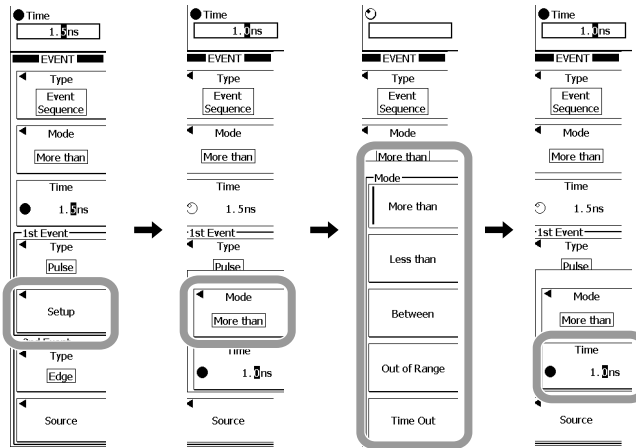

### Setting the Event Source

17. If the event type is Edge, Edge(Qualified), or State press the **Source** soft key. The setup menu appears.

If the event type is a Width type or Serial type, press **SOURCE** on the front panel and press the **Setup** soft key in the menu that appears. You can also press **SOURCE** on the front panel and press the **Setup** soft key in the menu that appears if the event type is Edge, Edge(Qualified), or State.

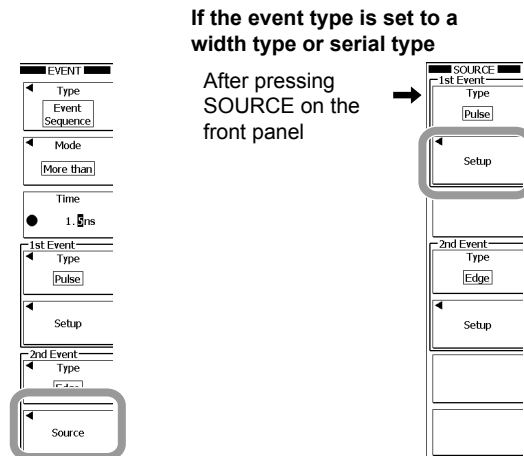

The subsequent operation varies depending on the event type. See the following sections for the trigger source settings.

Event Type		See Section:
Edge		Step 4 in section 6.7
Edge(Qualified)		Step 4 in section 6.8
State		Step 4 in section 6.9
Width type	Pulse	Step 8 in section 6.11
	Pulse(Qualified)	Step 8 in section 6.12
	Pulse State	Step 8 in section 6.13
Serial type	Serial	Step 9 in section 6.18
	I2C	Step 30 in section 6.19
	CAN	Step 34 in section 6.20
	LIN	Step 7 in section 6.21
	SPI	Step 17 in section 6.22

**Explanation**

Normally, the waveform before and after the event is displayed, but if you want to monitor the waveform through a set sequence of events, set event sequence.

The trigger is activated when the time interval from the point when event 1 occurs until the point when event 2 first occurs satisfies the time condition that was set. When the time from when event 1 occurs until event 2 occurs for the first time does not satisfy the set time condition, event 2 is ignored and the trigger is activated at an event 2 that occurs when the set time condition is met. The following example shows the case of “More Than.”

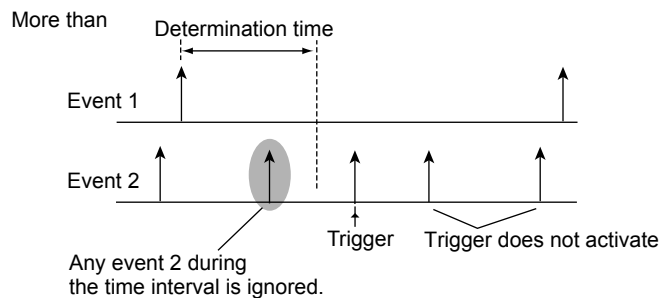
**Event Mode**

More than	When the time interval from event 1 to event 2 is longer than the specified time, a trigger is activated at the event 2 occurrence.
Less than	When the time interval from event 1 to event 2 is shorter than the specified time, a trigger is activated at the event 2 occurrence.
Between	When the time interval from event 1 to event 2 is longer than the specified T1 time and shorter than the specified T2 time, a trigger is activated at the event 2 occurrence.
Out of Range	When the time interval from event 1 to event 2 is shorter than the specified T1 time or longer than the specified T2 time, a trigger is activated at the event 2 occurrence.
Time out	When the time interval from event 1 to event 2 is longer than the specified time, a trigger is activated the specified time after the event 1 occurrence.

**Setting the Try Mode**

This setting is the same as that of the event delay. See section 6.15.

**Setting the Determination Time of the Event**

This setting is the same as that of the event delay. See section 6.15.

**Setting the Event Type**

Set a trigger excluding Edge OR trigger and TV trigger as the event. For details, see the section for the respective trigger.

**Setting the Event Source**

Set a trigger source excluding Edge OR trigger and TV trigger as the event source. For details, see the section for the respective trigger.



## 6.17 Setting the TV Trigger (ENHANCED)

### Procedure

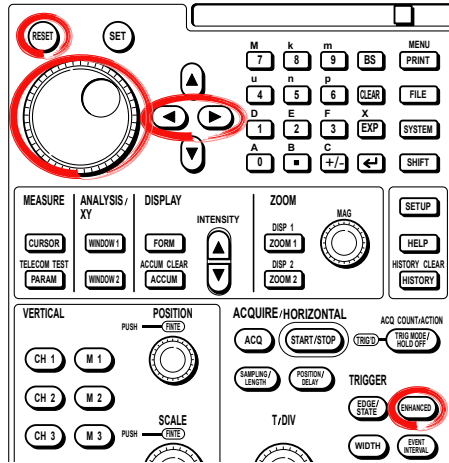

### Selecting the TV Trigger

1. Press **ENHANCED**. The ENHANCED menu appears.
2. Press the **Type** soft key. The Type menu appears.
3. Press the **TV** soft key.

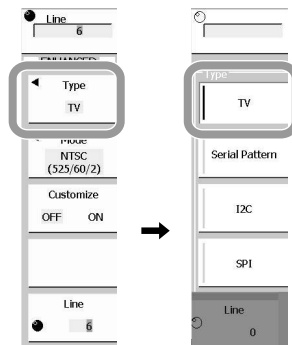

**Selecting the Broadcasting Type of the Video Signal**

4. Press the **Mode** soft key. The mode menu appears.
5. Press the soft key corresponding to the broadcast type of the desired video signal.
  - If you select User, proceed to step 9.
  - On products with firmware version 3.6 or later, SDTV (480/60p) has been added to the menu. And you can select this from the menu that appears when the HDTV soft key is pressed.

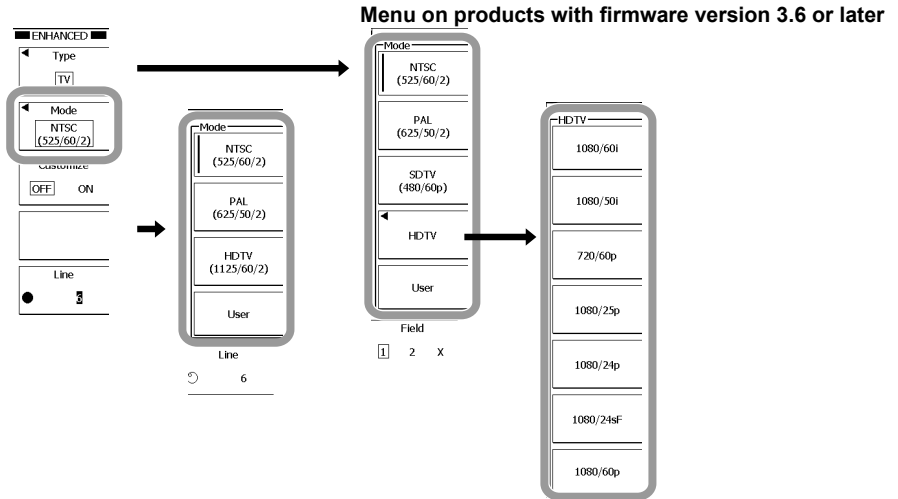

**Setting Customize (When other than User is selected in step 5)**

6. Press the **Customize** soft key to select ON or OFF. If OFF is selected, proceed to step 12.

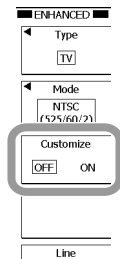

**Setting the Sync Guard Frequency (When other than User is selected in step 5)**

7. Press the **Sync Guard** soft key and set the rotary knob target to Sync Guard.
8. Turn the **rotary knob** to set the count.
  - Press RESET to set the sync guard frequency to 75%/Hsync.
  - You can move between the digits using the arrow keys.
  - Proceed to step 12.

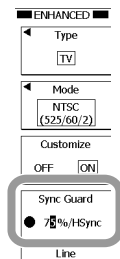

## 6.17 Setting the TV Trigger (ENHANCED)

### Setting the Resolution (When User is selected in step 5)

9. Press the **SD/HD** soft key, to select SD (standard definition) or HD (high definition).

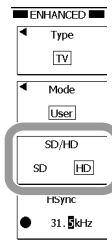

### Setting the Horizontal Sync Frequency (When User is Selected in Step 5)

10. Press the **HSync** soft key, to assign the rotary knob to HSync.
11. Turn the **rotary knob**, to set the frequency.  
Pressing RESET sets the horizontal sync frequency to 31.5 kHz.  
You can change the digit being set, with the arrow keys.

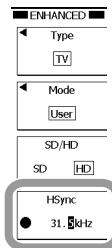

### Selecting the Line Number

12. Press the **Line** soft key, and set the rotary knob target to Line.
13. Turn the **rotary knob** to select the line number.  
Pressing RESET sets the line number to 2, 5, or 8 depending on the broadcast type setting.

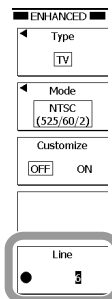

### Selecting the Field Number

14. Press the **Field** soft key to select 1, 2, or X.

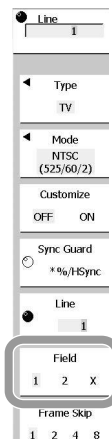

**Selecting Frame Skip**

15. Press the **Frame Skip** soft key to select either 1, 2, 4, or 8 for the frame skip value.

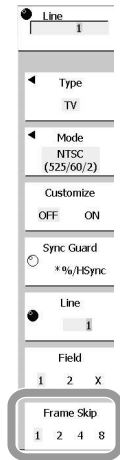

**Setting the Channel**

16. Press **SOURCE**. The SOURCE menu appears.
17. Press the soft key corresponding to the channel to be set.
18. Press the **Polarity** soft key to set the polarity to either Pos (positive) or Neg (negative).

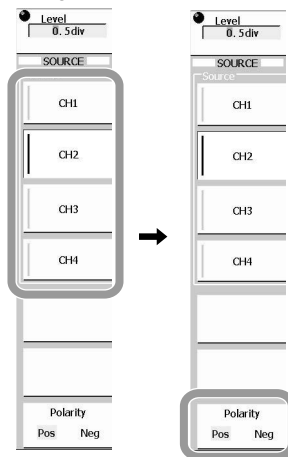

**Setting the Level, Trigger Coupling, and HF Rejection**

19. Press **LEVEL/COUPLING**. The Level/Coupling menu appears.
20. Set the Level, Trigger Coupling, and HF Rejection.  
For the setting procedure, see section 6.3.

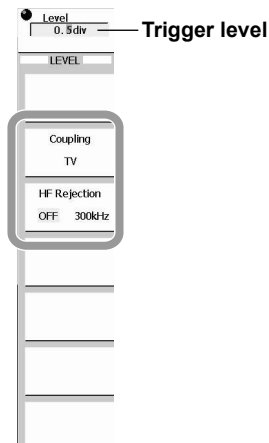

**Explanation**

**Broadcast Types That TV Trigger Supports**

You can select the broadcast type.

NTSC(525/60/2), PAL(625/50/2), SDTV(480/60p)\*1, HDTV(1080/60i\*1, 1080/50i\*1, 720/60p\*1, 1080/25p\*1, 1080/24p\*1, 1080/24sF\*1, 1080/60p\*1, 1125/60/2\*2), USER

\*1 Available on products with firmware version 3.6 or later.

\*2 Has been replaced by 1080/60i on products with firmware version 3.6 or later.

**Field Number**

You can select the field number to be detected.

1	Detect a field in which the start of the vertical sync pulse and the start of the line is at the same time.
2	Detect a field in which the start of the vertical sync pulse is delayed by 1/2 H (H is the horizontal scan interval) of the start of the line.
X	Detect both.

**Line Number**

A trigger is activated at the start of the line of the specified number.

Broadcast Type	Selectable Range
NTSC	5 to 1054
PAL	2 to 1251
SDTV	8 to 2251, applicable to products with firmware version 3.6 or later.
HDTV	2 to 1251. 2 to 2251 on products with firmware version 3.6 or later.
User	2 to 2041. 2 to 2251 on products with firmware version 3.6 or later.

• **NTSC Example**

The line numbers below are for the case when the field number is set to 1.  
(If the field number is set to 2, the numbers are assigned sequentially by setting 268 to 5.)

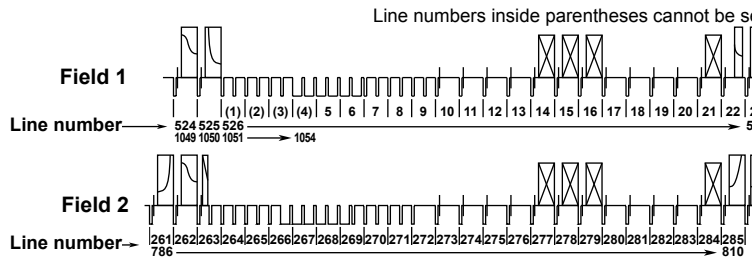

• **PAL Example**

The line numbers below are for the case when the field number is set to 1.  
(If the field number is set to 2, the numbers are assigned sequentially by setting 315 to 2.)

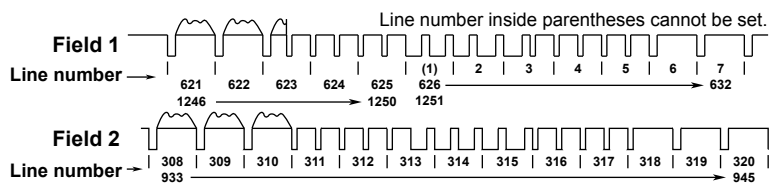

• **SDTV Example**

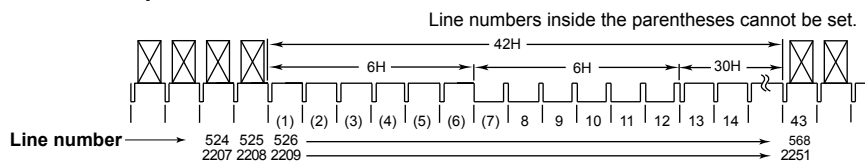

• **1080/60i, 1080/50i, and 1080/24sF Example**

The line numbers below are for the case when the field number is set to 1.  
(Numbers assigned sequentially with 565 set to 2 if the field number is set to 2.)

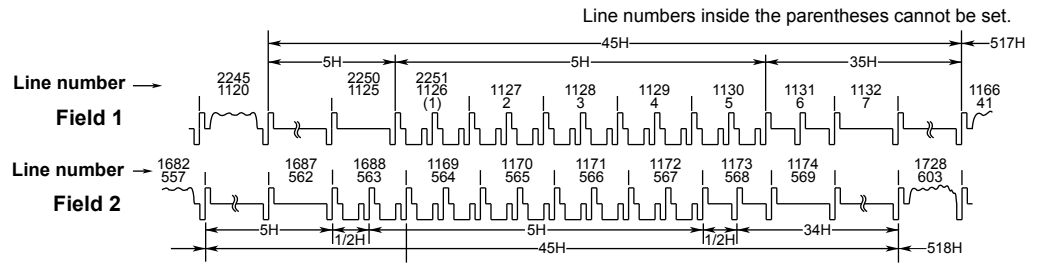

• **720/60p Example**

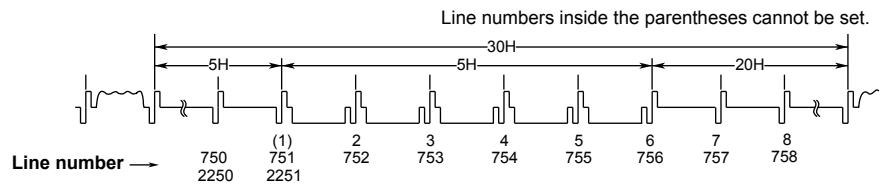

• **1080/25p, 1080/24p, and 1080/60p Example**

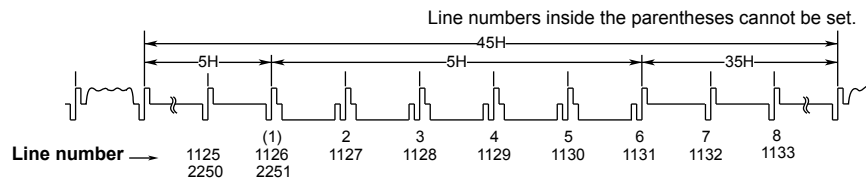

**Frame Skip**

This function is used to skip frames such as when the color burst is inverted every frame. You can select the number of frames at which this operation is repeated.

- |   |   |
|---|---|
| 1 | Activates a trigger at the specified field every time.  |
| 2 | Skips 1 frames and activates a trigger at the specified field of the succeeding frame. This operation is repeated every 2 frames. |
| 4 | Skips 3 frames and activates a trigger at the specified field of the succeeding frame. This operation is repeated every 4 frames. |
| 8 | Skips 7 frames and activates a trigger at the specified field of the succeeding frame. This operation is repeated every 8 frames. |

**Note**

Hold-off, trigger coupling, and HF rejection settings are ignored.

## 6.18 Setting the Trigger Conditions of the Serial Pattern Signal (ENHANCED)

This function can be used on products with firmware version 1.60 or later.

### Procedure

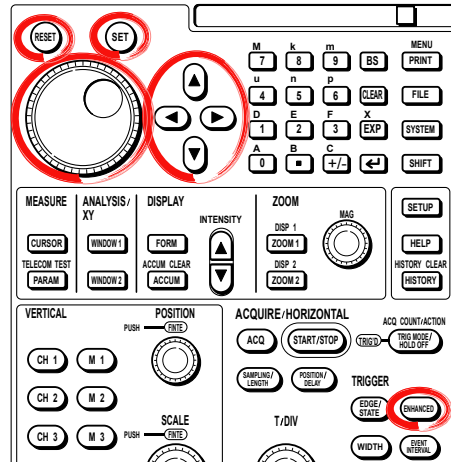

### Setting the Trigger Conditions of the Serial Pattern Signal

1. Press **ENHANCED** to display the ENHANCED menu.
2. Press the **Type** soft key to display the Type menu.
3. Press the **Serial** soft key.
4. Press the **Clock** soft key to select ON or OFF.
  - ON: Proceed to step 6. You must set the CS signal, clock source, and latch source (see pages 6-70 and 6-71).
  - OFF: Proceed to step 5.
5. Turn the **rotary knob** to set the bit rate.
6. Press the **Set Pattern** soft key to display the data setup dialog box.

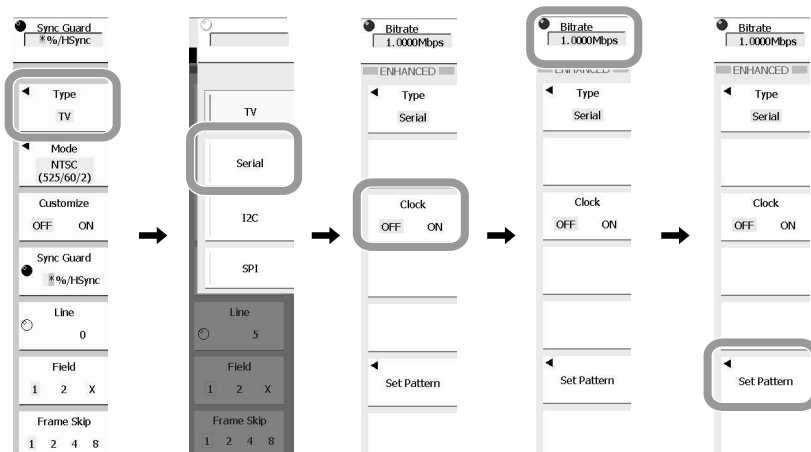

## 6.18 Setting the Trigger Conditions of the Serial Pattern Signal (ENHANCED)

- Set the trigger pattern according to the procedural explanation in the figure below.

**Pattern data area** (Up to 128 bits of data can be entered. Data exceeding 128 bits is discarded.)

The cursor position is the entry position.

When entering in hexadecimal notation

When entering in binary notation

The soft keys can also be used to select Bin or Hex, move the cursor, and delete or insert data.

Name of the signal being configured

Turn the rotary knob or arrow keys to select an operation or an entry value, and press SET. The selected operation is executed, or the value is entered in the pattern area.

- ← Moves the cursor to the left.
- Moves the cursor to the right.
- ↑ Moves the cursor up.
- ↓ Moves the cursor down.

**BS** Backspace

**DEL** Delete

**Clr** Clears the entire entered data. Cleared data cannot be recovered.

**INS** Switches between insert and overwrite mode.

**0 to F** A hexadecimal value. Displayed when the Hex box is selected.

**0 to 1** A binary value. Displayed when the Bin box is selected.

**X** Enter X when not using the value as a condition.

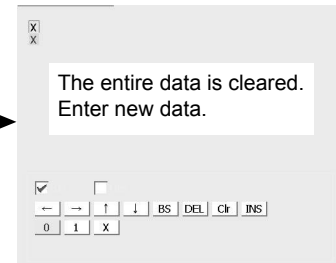

**For Hex entry**

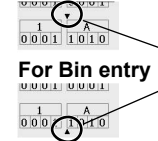

### Note

If any of the binary box in each set of four bits is set to "X," the hexadecimal box displays "\$."

- Press **SOURCE** to display the SOURCE menu.

#### • Setting the Data Source

- Press the **Source** soft key to display the Data Source menu.
- Press any of the **CH1** to **CH4** soft keys to select the data source.
- Press the **Active** soft key to select H or L.

When Clock is set to OFF in step 4

When Clock is set to ON in step 4



## 6.18 Setting the Trigger Conditions of the Serial Pattern Signal (ENHANCED)

Carry out steps 12 to 22 below if you set the Clock to ON in step 4 on page 6-68.

### • Setting the CS Signal

12. Press the **CS** soft key to display the CS menu.
13. Press the **CS** soft key to select ON or OFF.
  - ON: Proceed to step 14.
  - OFF: Proceed to step 16.
14. Press each channel soft key to select H, L, or X.
15. Press the **Logic** soft key to select AND or OR.
  - AND: Determines that the CS is detected when the conditions of all channels are met.
  - OR: Determines that the CS is detected when any of channel conditions is met.
16. Press **ESC** to return to the previous screen.

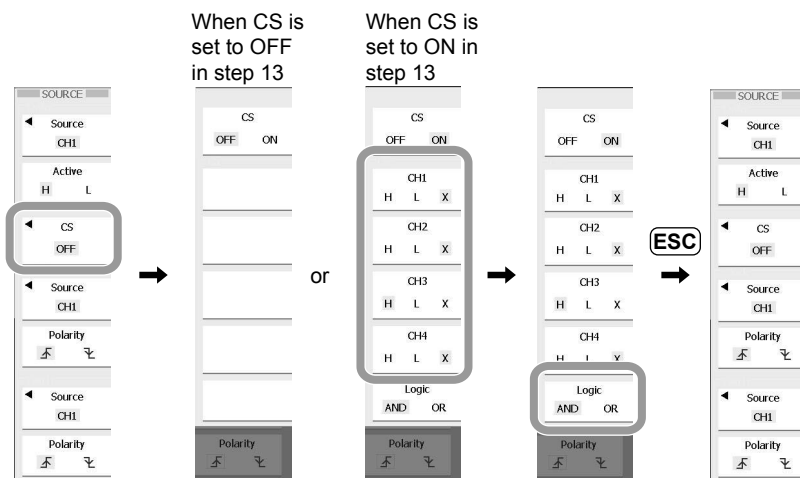

### • Setting the Clock Source

17. Press the **Source** soft key to display the Clock Source menu.
18. Press any of the **CH1** to **CH4** soft keys to select the clock source.
19. Press the **Polarity** soft key to select  $\uparrow$  or  $\downarrow$ .

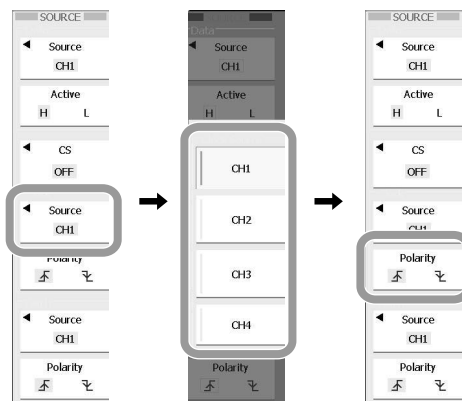

## 6.18 Setting the Trigger Conditions of the Serial Pattern Signal (ENHANCED)

- **Setting the Latch Source**

20. Press the **Source** soft key to display the Latch Source menu.
21. Press any of the **CH1** to **CH4** and **X** soft keys to select the latch source.
22. Press the **Polarity** soft key to select  $\uparrow$  or  $\downarrow$ .

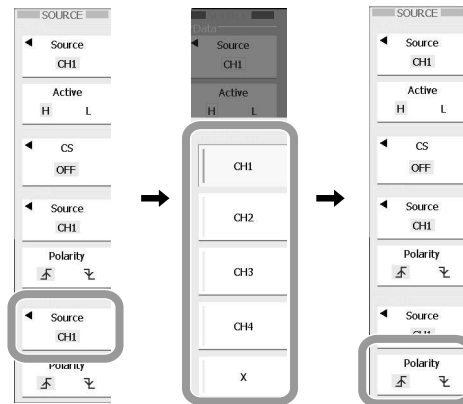

### Setting the Level, Coupling, HF Rejection, and Hysteresis

23. Press **LEVEL/COUPLING**. The LEVEL/COUPLING menu appears.

- **Selecting the Channel to Be Configured**

24. Press the **CH** soft key. The menu used to select the channel appears.
25. Press any of the soft keys, **CH1** to **CH4**.

- **Setting the Level**

26. Turn the **rotary knob** to set the level used to determine high/low.

- **Selecting the Coupling**

27. Press the **Coupling** soft key to select DC.

- **Selecting the HF Rejection**

28. Press the **HF Rejection** soft key. The menu used to select the HF rejection appears.
29. Press the **OFF**, **20MHz**, or **15kHz** soft key.

- **Selecting the Hysteresis**

30. Press the **Hysteresis** soft key to select the hysteresis.

As necessary, repeat steps 24 to 30.

**Explanation**

This is a trigger function for capturing serial pattern signals. This function can be used on products with firmware version 1.60 or later.

**Setting the Clock Source**

This function detects the serial data pattern in sync with the selected clock signal. You can select whether to synchronize to the rising or falling edge of the clock.

- ON: Select the clock source from CH1 to CH4.
- OFF: Set the bit rate in the range of 1 k to 50 Mbps instead of selecting the clock source from the channels.

**Setting the Serial Data Pattern**

You can specify a serial data pattern as a condition for activating a trigger. Up to 128 bits can be specified. When Pattern Format is set to Hex (hexadecimal), you can enter X, 0 to 9, or A to F in units of 4 bits. When Pattern Format is set to Bin (binary), you can enter X, 0, or 1 for each bit. Enter X when not using the value as a condition.

**Setting the Data Source**

Select the data source for detecting the serial data pattern from CH1 to CH4. You can also select high active or low active.

**Setting the CS Signal**

You can control the period over which the data source is detected with the CS signal when the clock source is turned ON.

- ON: Select the CS signal from CH1 to CH4. You can also select the signal level state (H, L, or X) when the data source is to be detected. Select X when not using the value as a condition. You can also specify AND or OR logic to the conditions of multiple channels.
- OFF: Detects the data source at all times.

**Setting the Latch Source**

You can select the timing when the acquired serial data pattern is compared against the pattern specified as a trigger condition when the clock source is turned ON. Select the latch source from CH1 to CH4 and X. If X is selected, comparison is made every clock. You can select whether to synchronize to the rising or falling edge for making the comparison.

**Setting the Trigger Level, Trigger Coupling, Etc.**

Set the trigger level, hysteresis, trigger coupling, and HF rejection of each channel. For details on the trigger level, hysteresis, trigger coupling, and HF rejection, see section 6.3.

**Example of the Trigger Condition Setting of a Serial Pattern Signal**

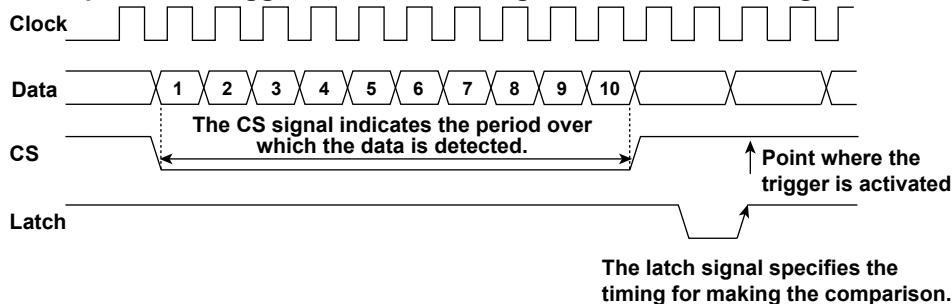

## 6.19 Setting the Trigger Conditions of the I<sup>2</sup>C Bus Signal (ENHANCED)

This function can be used on products with firmware version 1.60 or later.

### Procedure

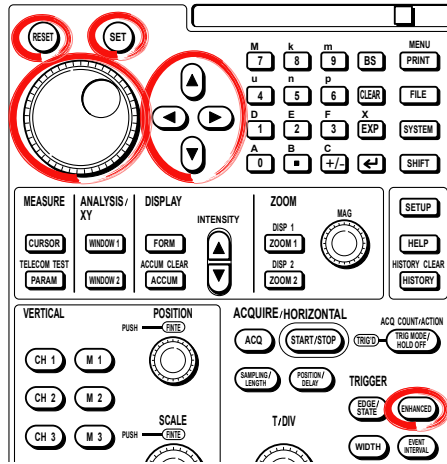

### Setting the Trigger Conditions of the I<sup>2</sup>C Bus Signal

1. Press **ENHANCED** to display the ENHANCED menu.
2. Press the **Type** soft key to display the Type menu.
3. Press the **I<sup>2</sup>C** soft key.

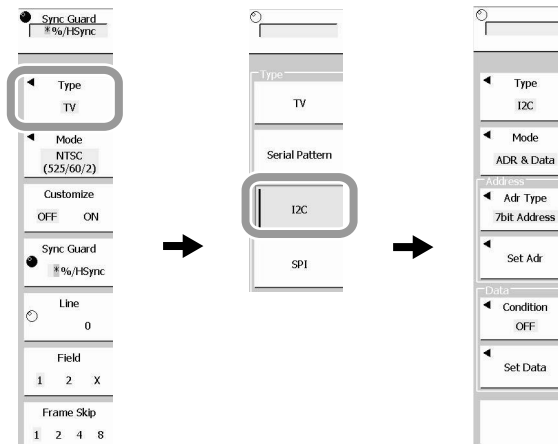

## 6.19 Setting the Trigger Conditions of the I<sup>2</sup>C Bus Signal (ENHANCED)

4. Press the **Mode** soft key to display the Mode menu.

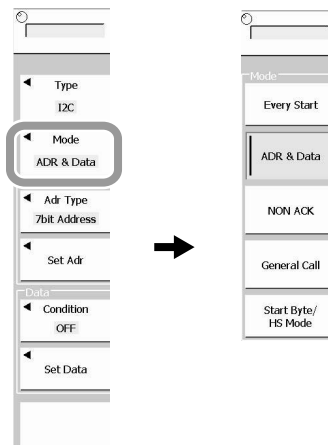

Proceed to the steps indicated below depending on the specified mode.

- Every Start (when a start condition is detected): The setting procedure is complete.
- ADR & Data (trigger on an address pattern or data pattern): Step 5 on the below
- NON ACK (trigger when a Nack is detected): Step 20 on page 6-76
- General Call (trigger on the general call address): Step 22 on page 6-76
- Start Byte/HS Mode (trigger on the start byte or HS mode start condition): Step 27 on page 6-77

### When Activating a Trigger on the Start Condition or Address Pattern/Data Pattern

5. Press the **ADR & Data** soft key.

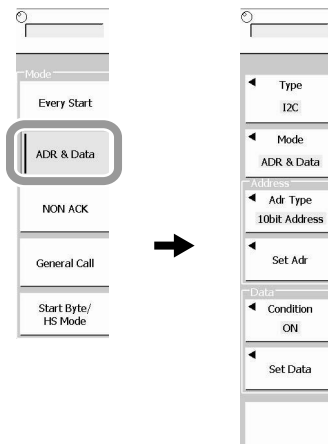

## 6.19 Setting the Trigger Conditions of the I<sup>2</sup>C Bus Signal (ENHANCED)

### • Setting the Address Type

6. Press the **Adr Type** soft key to display the address type selection menu.
7. Press the soft key corresponding to the desired address type.
8. Press the **Set Adr** soft key to display an address pattern setting screen. The screen varies depending on the specified address type.
9. Turn the **rotary knob**, **arrow** keys, and **SET** key to set the pattern. You can use the soft keys to change the format to binary or hexadecimal or delete all the setting value (X).
10. Press **ESC** to return to the previous screen.

#### 7bit Address in binary

B	X	R/W bit	
1	0	1	1

<input checked="" type="checkbox"/> Bin	<input type="checkbox"/> Hex
←	→
0	1 X Clr

#### 7bit Address in hexadecimal

B	X	R/W bit	
1	0	1	1

<input type="checkbox"/> Bin	<input checked="" type="checkbox"/> Hex		
←	→		
D	E	F	Clr
A	B	C	
7	8	9	
4	5	6	
1	2	3	
0	X		

#### 7bit + Sub Adr

r Address		r Sub Address		R/W bit	
X	X	X	X	X	X
X	X	X	X	X	X

<input checked="" type="checkbox"/> Bin	<input type="checkbox"/> Hex
←	→
0	1 X Clr

#### 10bit Address

F	S	X	X	R/W bit	
1	1	1	0	X	X

<input checked="" type="checkbox"/> Bin	<input type="checkbox"/> Hex
←	→
0	1 X Clr

## 6.19 Setting the Trigger Conditions of the I<sup>2</sup>C Bus Signal (ENHANCED)

- **Setting the Data Pattern**

11. Press the **Condition** soft key to display a data pattern setting menu.
12. Press the **Data** soft key to select ON (use a data pattern) or OFF (not use a data pattern). If you select ON, continue with the steps below. If you select OFF, you are done.
13. Press the **Condition** soft key to select True (activate a trigger when the data matches the specified data pattern) or False (activate a trigger when the data does not match the specified data pattern).
14. Press the **Pos Mode** soft key to select X (ignore) or Select.
15. Turn the **rotary knob** to set the data position (position where the pattern is compared).
16. Press the **1 byte**, **2 byte**, **3 byte**, or **4 byte** soft key to set the data size.
17. Press **ESC** to return to the previous screen.
18. Press the **Set Data** soft key. The screen used to set the data pattern appears.
19. Use the **rotary knob**, **arrow** keys, and **SET** key to set the pattern.

You can use the soft keys to change the format to binary or hexadecimal or delete the value (X).

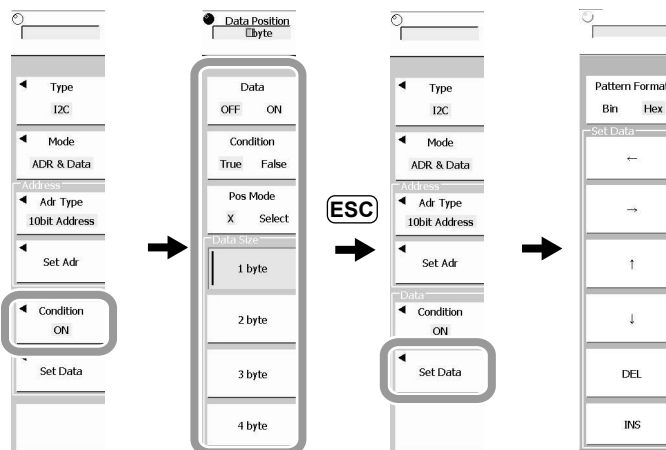

**When Activating a Trigger When a Nack Is Detected**

20. After step 4 of page 6-73, press the **NON ACK** soft key.
21. Set whether to discard the Nack of Start byte, HS Mode, and Read Access or include them in the trigger conditions.  
Press each of the **Start byte**, **HS Mode**, and **Read Access** soft keys and select OFF (include in the trigger conditions) or ON (not include in the trigger conditions).

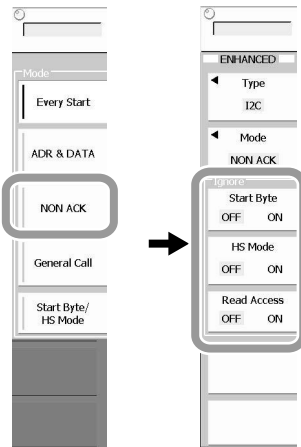

**Activating Triggers on an General Call Data Pattern**

22. After step 4 of page 6-73, press the **General Call** soft key.
23. Press the **Second Byte** soft key to display a menu used to select the format of the Second Byte.
24. Press a soft key corresponding to the desired Second Byte format.  
If you select X, 0000 0100, or 0000 0110, you are done.
25. If you set Second Byte format to 7bit Master Adr, set the data pattern in the same fashion as “Setting the Data Pattern” two pages before this page.

• **Setting the Data Pattern**

Set the data pattern that is applied if the Second Byte format is set to 7bit Master Adr in step 24.

26. Set the data pattern in the same fashion as described in “Setting the Data Pattern” on the previous page.

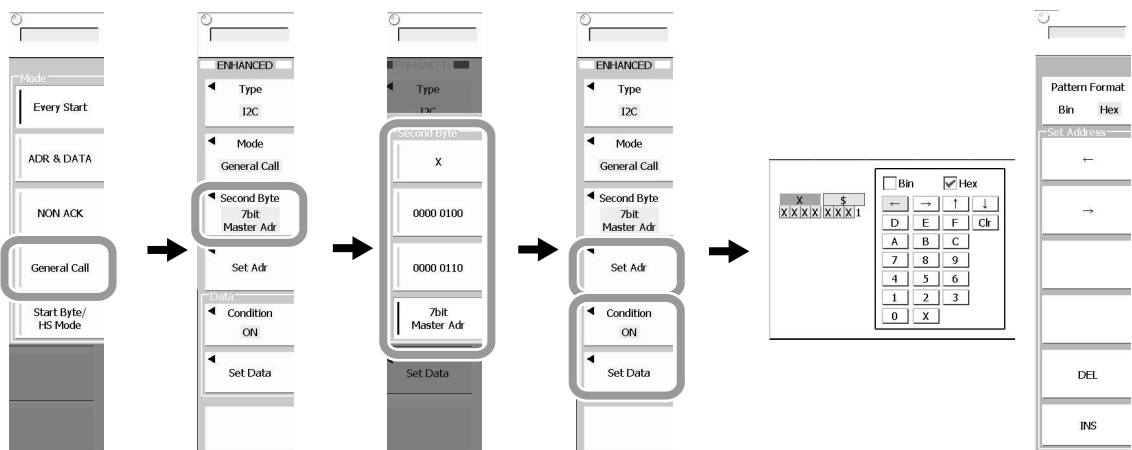



## 6.19 Setting the Trigger Conditions of the I<sup>2</sup>C Bus Signal (ENHANCED)

### Activating a Trigger on the Start Byte or HS Mode Start Condition

- After step 4 of page 6-73, press the **Start Byte/HS Mode** soft key.
- Press the **Start byte** or **HS Mode** soft key to select whether to activate a trigger on the start byte or high speed mode start condition.

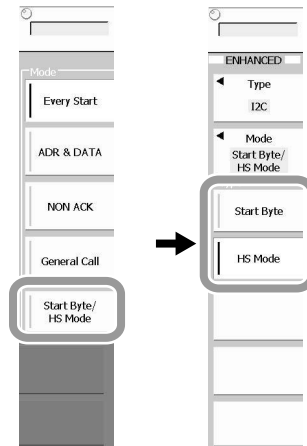

### Setting the Source Channel

- Press **SOURCE** on the front panel to display the SOURCE menu.

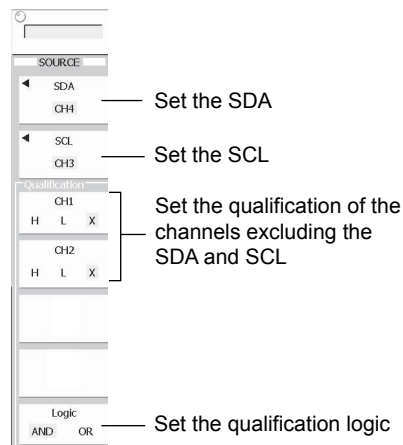

#### Set the SDA

- Press the **SDA** soft key to display a menu used to select a channel to be the SDA.
- Press any of the soft keys **CH1** to **CH4** to assign the channel to the SDA.

#### Set the SCL

- Press the **SCL** soft key to display a menu used to select a channel to be the SCL.
- Press any of the soft keys **CH1** to **CH4** to assign the channel to the SCL.

#### Set the qualification of the channels excluding the SDA and SCL

- Press a channel soft key other than the SDA and SCL channels to select H (high), L (low), or X (ignore). If you select H or L, a trigger is activated on the logical sum or product of the I<sup>2</sup>C trigger and Qualification.

**Setting the Qualification Logic**

- 35. Press the **Logic** soft key to select AND (logical product) or OR (logical sum).

**Setting the Level, Coupling, HF Rejection, and Hysteresis**

- 36. Press **LEVEL/COUPLING**. The LEVEL/COUPLING menu appears.

**Selecting the Channel to Be Configured**

- 37. Press the **CH** soft key. The menu used to select the channel appears.
- 38. Press any of the soft keys, **CH1** to **CH4**.

**Setting the Level**

- 39. Turn the **rotary knob** to set the level used to determine high/low.

**Selecting the Coupling**

- 40. Press the **Coupling** soft key to select DC.

**Selecting the HF Rejection**

- 41. Press the **HF Rejection** soft key. The menu used to select the HF rejection appears.
- 42. Press the **OFF**, **20MHz**, or **15kHz** soft key.

**Selecting the Hysteresis**

- 43. Press the **Hysteresis** soft key to select the hysteresis.

As necessary, repeat steps 37 to 43

**Explanation**

This is a trigger function for capturing I<sup>2</sup>C bus signals. This function can be used on products with firmware version 1.60 or later. I<sup>2</sup>C Bus is an abbreviation for Inter Integrated Circuit Bus. It is a bidirectional bus for connecting ICs. Note that the /F5 or /F8 option is required to analyze I<sup>2</sup>C bus signals.

**I<sup>2</sup>C Bus Signal Trigger Mode**

Select the trigger mode from the following list.

Every Start	Activate a trigger on the start condition
ADR&Data	Activate a trigger on the address pattern or data pattern (address & data trigger)
Non-ACK	Activate a trigger when an Acknowledge bit is not present (Non-Ack trigger)
General Call	Activate a trigger on the general call address pattern
Start Byte/HS Mode	Activate a trigger on the start byte or high speed mode start condition

### Every Start Trigger

When the start condition is detected, a trigger is activated on the falling edge of the SDA signal.

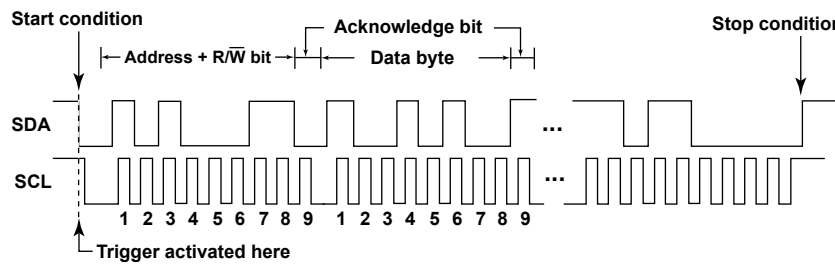

### ADR&Data Trigger

When the data matches the specified address pattern or data pattern, a trigger is activated on the 9<sup>th</sup> falling edge of the SCL (clock) signal.

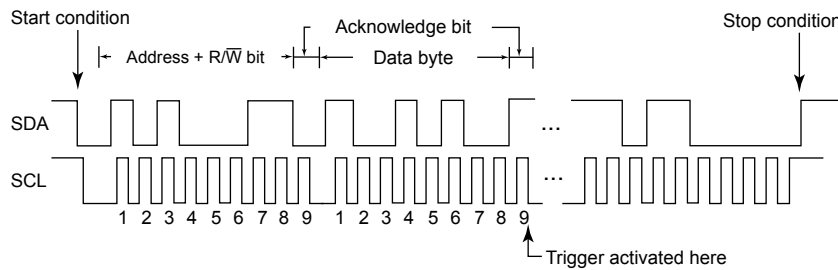

#### Address Type

Set the address type to 7-bit address, 7-bit + sub address, or 10-bit address.

#### Address

Set the pattern according to the address type. The data matching the specified pattern is one of the trigger conditions.

#### Data Condition

To activate a trigger on a data pattern, set Data to ON in data conditions, and set the Condition, Pos Mode, and data size items.

Select the pattern condition from below.

True	A trigger is activated when the data matches the data pattern.
False	A trigger is activated when the data does not match the data pattern.

Set the position in the pattern to be compared with Pos Mode in terms of the number of data bytes.

**Example**

This section will display the data sequence in bytes (hexadecimal notation) and indicate the position where the trigger will occur. The symbols used in the figures are as follows:

S: Start condition, P: Stop condition, and shading: Byte pattern to be compared

• **Activating a Trigger Only on the Address Pattern**

**Trigger Conditions**

Mode	ADR & Data
Address	Adr Type: 7bit address, Set Adr: A4
Data:	OFF

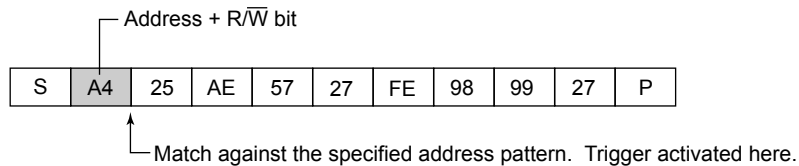

• **Activating a Trigger Only on the Data Pattern**

**Trigger Conditions**

Mode	ADR & Data
Address	Set Adr : Not applicable
Data	Data: On, Condition: True, Data Size: 2 bytes: Set Data: 27 and AE

**<Data Position: X>**

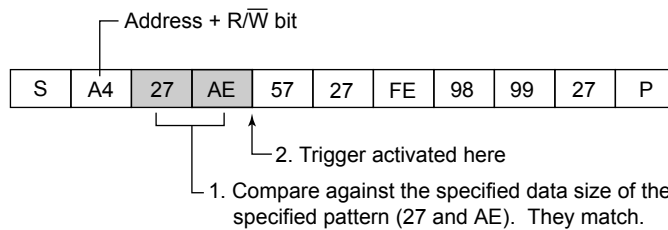

**<Data Position: 3>**

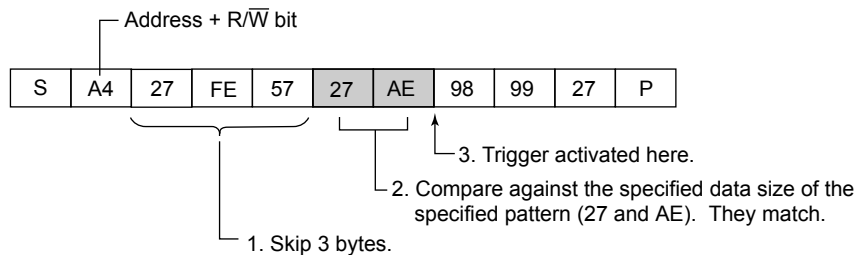

### Non-ACK Trigger

#### Activating a Trigger When the Acknowledge Bit Is H

A trigger is activated when the Acknowledge bit is Nack (when the SDA signal is set to "H").

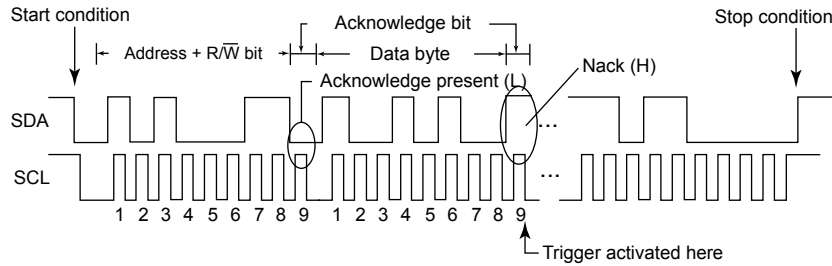

**Note**

You can select any of the Acknowledge bits, the status byte, HS mode master code, or read access byte, to be used for triggering.

### General Call Trigger

A trigger is activated on a general call address (address: 0000 0000).

The second byte pattern after the general call address can also be used for triggering.

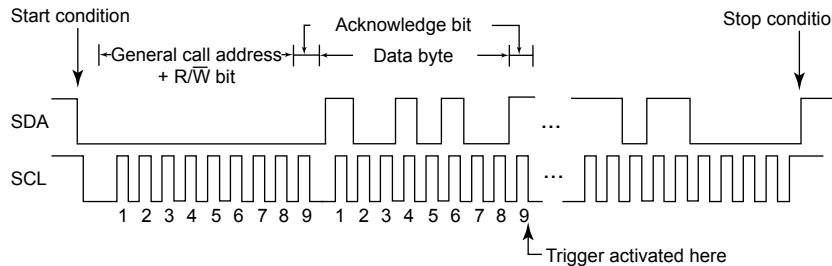

**Example**

This section will display the data sequence in bytes (hexadecimal notation) and indicate the position where the trigger will occur. The symbols used in the figures are as follows:

S: Start condition, P: Stop condition, and shading: Byte pattern to be compared

- **Activating a Trigger Only on the General Call Address**

**Trigger Conditions**

Mode	General Call
Second Byte	Not applicable

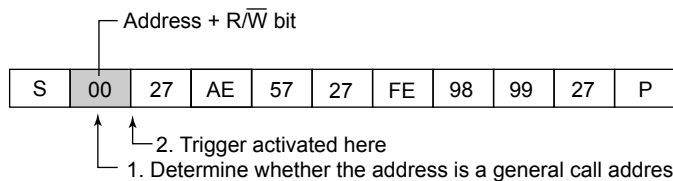

• **Activating a Trigger on the Second Byte Pattern Set to 06**

**Trigger Conditions**

Mode	General Call
Second Byte	0000 0110

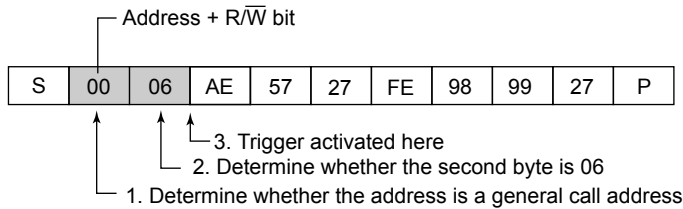

• **Activating a Trigger on an Arbitrary Pattern on the Second and Subsequent Bytes**

**Trigger Conditions**

Mode	General Call
Second Byte	7bit Master Adr (1010 1011)
Data	Data: On, Condition: True, Data Size: 2 bytes, Set Data: 27 and AE

**<Data Position:X>**

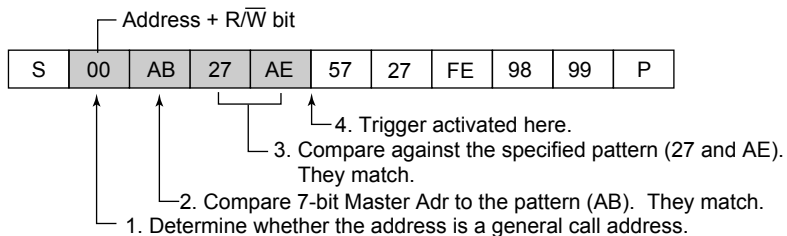

**<Data Position:3>**

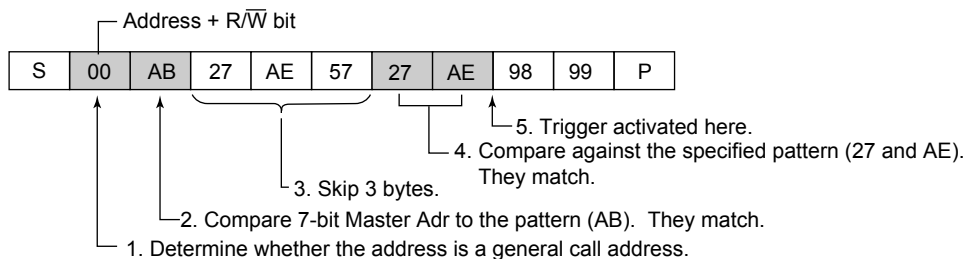

**Start Byte/HS Mode Trigger**

A trigger is activated on the start byte or HS mode master code.

**Start Byte (Address: 0000 0000)**

When a start byte is detected, a trigger is activated on the first rising edge of the SCL signal.

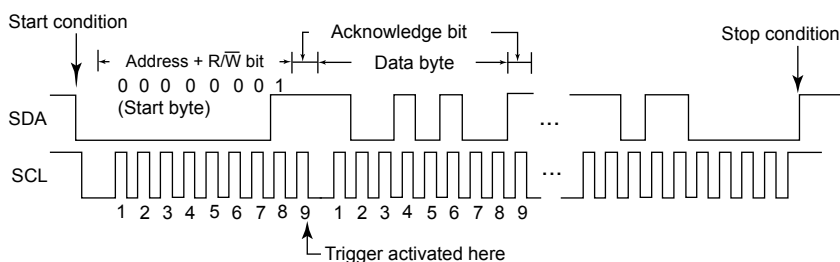

## 6.19 Setting the Trigger Conditions of the I<sup>2</sup>C Bus Signal (ENHANCED)

### HS Mode

A trigger is activated when the master code (Address: 0000 1xxx) of HS mode (high speed mode) is detected.

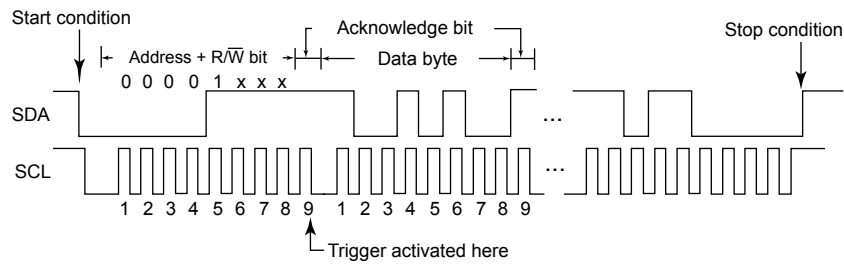

### Example

- **Activating a Trigger Only on the Start Byte**

#### Trigger Conditions

Mode	Start Byte/HS Mode
Type	Start byte

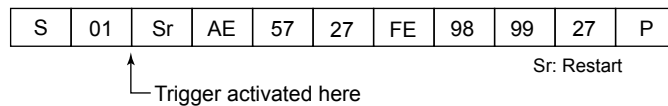

## Source Channel

The source channel of the I<sup>2</sup>C bus signal is set using the SOURCE menu that appears when you press the SOURCE key. The menu used to set the source channel of the I<sup>2</sup>C bus signal appears only when Type is set to I<sup>2</sup>C in the ENHANCED menu.

### Specifying the I<sup>2</sup>C Bus Signal (SDA and SCL Signals)

The SDA and SCL signals are assigned to channels using the SOURCE menu.

### Trigger Conditions of the Channels Other Than I<sup>2</sup>C Bus Signal (Qualification)

A trigger can be activated on the combination of the trigger conditions of the I<sup>2</sup>C bus signal (SDA/SCL signal) and the trigger conditions of the channels other than the I<sup>2</sup>C bus signal. Select the trigger conditions of the channels other than the I<sup>2</sup>C bus signal from the following:

H	The trigger source level is above the preset trigger level.
L	The trigger source level is below the preset trigger level.
X	Not used as a trigger source.

### Logic

If the trigger condition of a channel other than the SDA or SCL signal is set to H or L, a trigger is activated on the trigger conditions of the I<sup>2</sup>C bus signal and the trigger conditions of the channels other than the SDA and SCL signals. Select the logic to be used from the following:

AND	A trigger is activated when both the trigger conditions of the I <sup>2</sup> C bus signal and the trigger conditions of the channels other than the I <sup>2</sup> C bus signal are met.
OR	A trigger is activated when either the trigger conditions of the I <sup>2</sup> C bus signal or the trigger conditions of the channels other than the I <sup>2</sup> C bus signal are met.

## 6.19 Setting the Trigger Conditions of the I<sup>2</sup>C Bus Signal (ENHANCED)

CH3 = L, CH4 = H, and Logic = AND

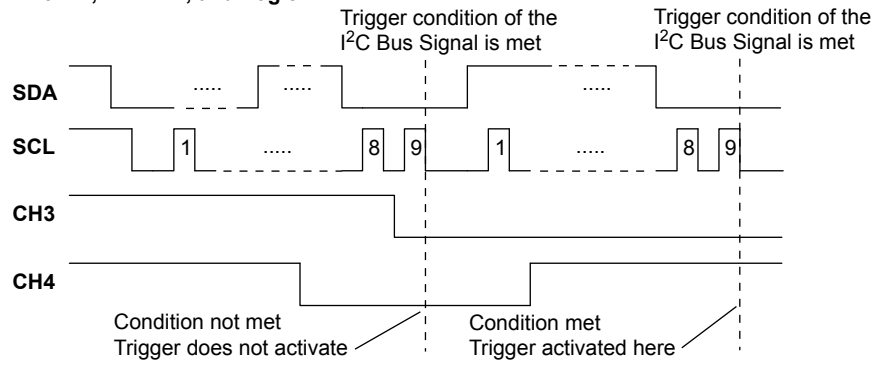

### Note

To activate a trigger only on the SCL and SDA signals (trigger condition of the I<sup>2</sup>C bus), set the status of the other channels to ignore (X), and set the logic to AND.

### Setting the Trigger Level, Trigger Coupling, Etc. (Level/Coupling)

Set the trigger level, hysteresis, trigger coupling, and HF rejection of each channel.

For details on the trigger level, hysteresis, trigger coupling, and HF rejection, see section 6.3.



## 6.20 Setting the Trigger Conditions of the CAN Bus Signal (ENHANCED)

This function can be used on products with firmware version 2.00 or later.

### Procedure

#### Setting the Trigger Conditions of the CAN Bus Signal

1. Press **ENHANCED**. The ENHANCED menu appears.
2. Press the **Type** soft key. The trigger type selection menu appears.
3. Press the **CAN** soft key.

#### Selecting the Trigger Mode

4. Press the **Mode** soft key. A menu used to select the trigger mode of the CAN bus signal appears.
5. Press the **SOF**, **Error Frame**, **ID Std/Data**, **ID Ext/Data**, or **ID/Data OR** soft key to set the trigger mode.

#### Setting the Bit Rate and Sample Point

6. Press the **Rate/Sample** soft key.
7. Press the **Bitrate** soft key. The bit rate selection menu appears.
8. Press the **1Mbps**, **500kbps**, **250kbps**, **125kbps**, **83.8kbps**, **33.3kbps** (33.3kbps supported by firmware version 2.40 or later), or **User** soft key to select the bit rate. If you select User, press the Bitrate soft key and turn the rotary knob to set an arbitrary value.
9. Press the **Sample Point** soft key.
10. Turn the **rotary knob** to set the sample point.

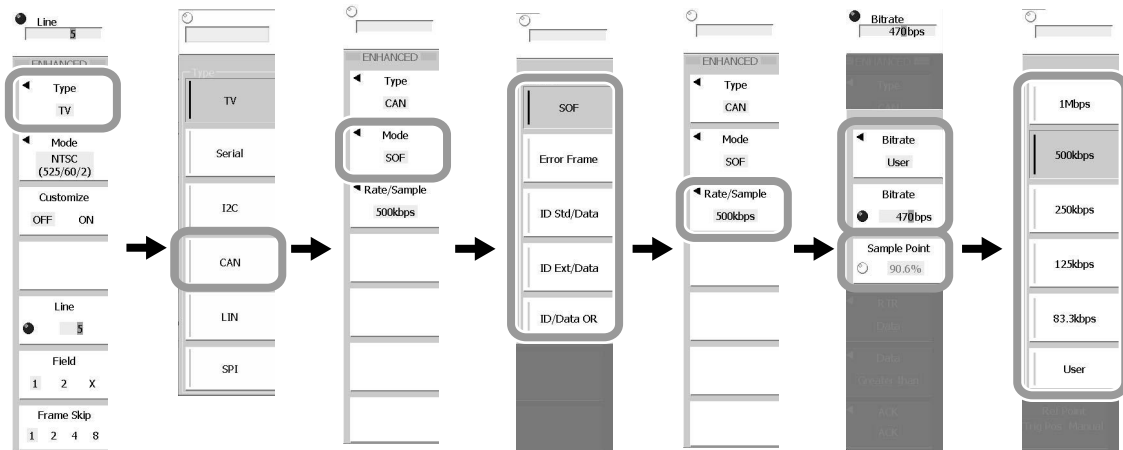

Proceed to the respective step depending on the trigger mode you selected in step 5.

- SOF (trigger on the Start of Frame): Step 33
- Error Frame (trigger on an error frame): Step 33
- ID Std/Data (trigger on the data/remote frame (ID: standard format)): Step 11
- ID Ext/Data (trigger on the data/remote frame (ID: extended format)): Step 11
- ID/Data OR (trigger on the OR condition of multiple data/remote frames): Step 30

If You Selected ID Std/Data or ID Ext/Data in Step 5

Setting the ID Bit Pattern

11. Press the **Set ID** soft key. The ID setup screen appears.
12. Use the **rotary knob**, **arrow** keys, and **SET** key to set the ID pattern.  
You can use the soft keys to change the format to binary or hexadecimal, move between bits, or clear all the bits (X).
13. Press **ESC**.

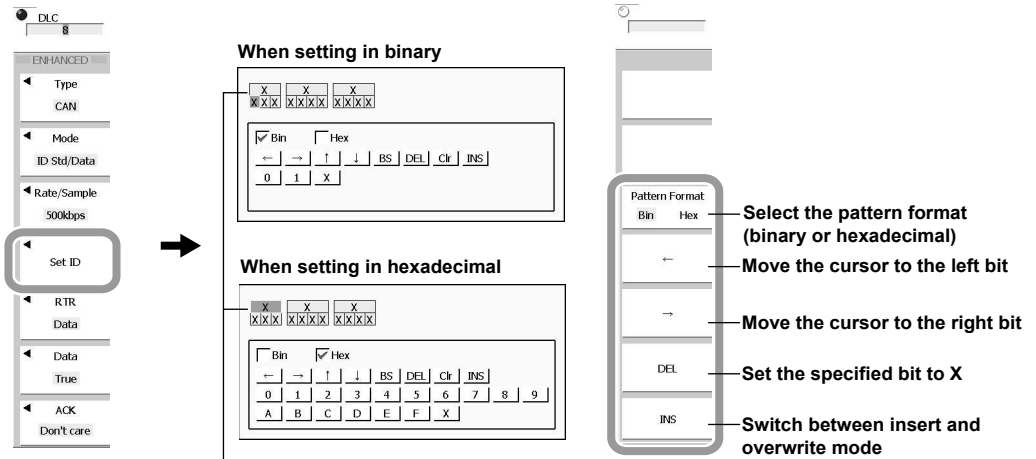

The figure above is the screen for ID Std/Data (ID: 11 bits).  
The ID is 29 bits for ID Ext/Data.

Setting the Remote Frame or Data Frame

14. Press the **RTR** soft key.
15. Press the **Don't care**, **Remote**, or **Data** soft key.
  - If you select Don't care, a trigger is activated on a remote frame or data frame. Proceed to step 28.
  - If you select Remote, a trigger is activated on a remote frame. Proceed to step 28.
  - If you select Data, a trigger is activated on a data frame. Proceed to step 16.

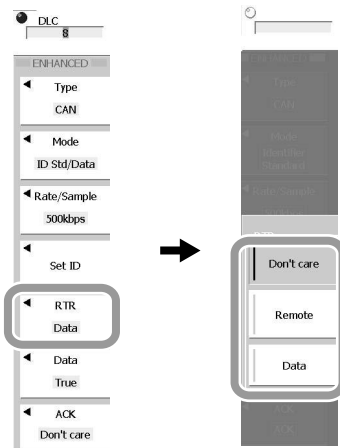

## 6.20 Setting the Trigger Conditions of the CAN Bus Signal (ENHANCED)

- **Setting the DLC**

16. Turn the **rotary knob** to set the DLC (number of valid bytes).

- **Setting the Data Field Condition**

17. Press the **Data** soft key.
18. Press the **Condition** soft key.
19. Press the **Don't care**, **True**, **False**, **Greater/Equal**, **Less/Equal**, **Between**, or **Out of Range** soft key.
  - If you select Don't care, trigger is activated when the DLC matches. Proceed to step 28.
  - If you select True, a trigger is activated when Data in the data field matches the specified bit pattern. Proceed to step 20.
  - If you select False, a trigger is activated when Data in the data field does not match the specified bit pattern. Proceed to step 20.
  - If you select Greater/Equal, a trigger is activated when Data in the data field is greater than or equal to the specified comparison data. Proceed to step 22.
  - If you select Less/Equal, a trigger is activated when Data in the data field is less than or equal to the specified comparison data. Proceed to step 22.
  - If you select Between, a trigger is activated when Data in the data field is greater than or equal to the specified comparison data Data1, and less than or equal to the comparison data Data2. Proceed to step 22.
  - If you select Out of Range, a trigger is activated when Data in the data field is less than the specified comparison data Data1, or greater than the comparison data Data2. Proceed to step 22.

### Note

For details on the trigger point for each condition, see page 6-99.

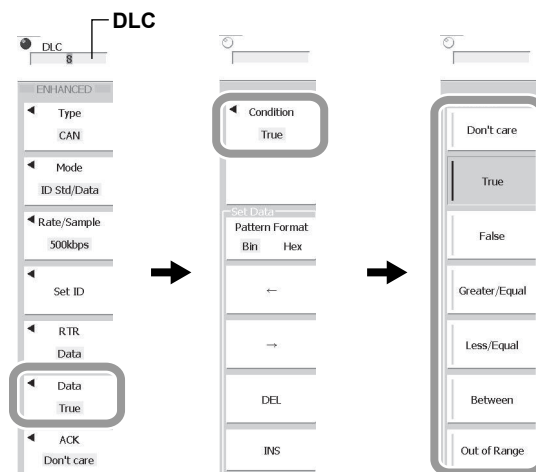

- **Setting the Data Bit Pattern**

If you selected True or False in step 19, a screen used to set the Data bit pattern appears.

20. Use the **rotary knob**, **arrow** keys, and **SET** key to set the Data bit pattern. You can use the soft keys to change the format to binary or hexadecimal, move between bits, or clear all the bits (X).
21. Press **ESC**. Proceed to step 28.

## 6.20 Setting the Trigger Conditions of the CAN Bus Signal (ENHANCED)

### When setting in binary

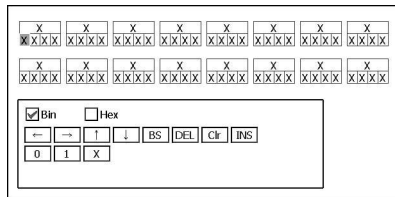

### When setting in hexadecimal

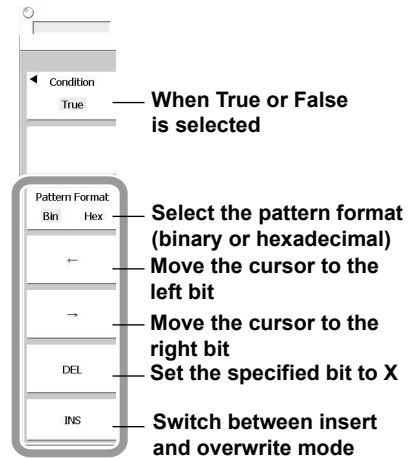
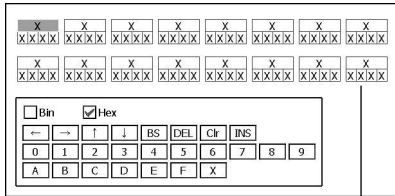

Set the pattern for the number of bytes specified by DLC.

- **Setting the Comparison Data**

If you select Greater/Equal, Less/Equal, Between, or Out of Range in step 19, a menu used to set the comparison data appears.

22. Press the **Byte Order** soft key to set the Endian of the value to Big or Little.

23. Press the **Sign** soft key to set the sign of the value to Sign (with a sign) or Unsign (without a sign).

24. Press the **MSB/LSB** soft key to set the MSB and LSB positions of the comparison data.

25. Press the **Data** soft key.

26. Turn the **rotary knob** to set the comparison data (Data, Data1, and Data2) in decimal notation.

If you select Greater/Equal or Less/Equal, set Data. If you select Between or Out of Range, set Data1 and Data2.

27. Press **ESC**. Proceed to step 28.

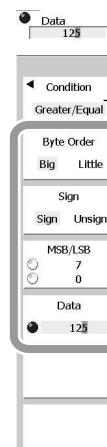

When Greater/Equal or Less/Equal is selected

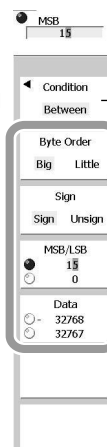

When Between or Out of Range is selected

## 6.20 Setting the Trigger Conditions of the CAN Bus Signal (ENHANCED)

### Setting the ACK Slot

28. Press the **ACK** soft key. The ACK slot setup menu appears.
29. Press the **Don't care**, **NON ACK**, **ACK**, or **NON ACK or ACK** soft key.
  - If you select Don't care, the bus level of the ACK slot is not used as a trigger condition.
  - If you select NON ACK, a trigger is activated when the bus level of the ACK slot is recessive.
  - If you select ACK, a trigger is activated when the bus level of the ACK slot is dominant.
  - If you select NON ACK or ACK, a trigger is activated when the ACK slot is recessive or dominant.

Proceed to step 33.

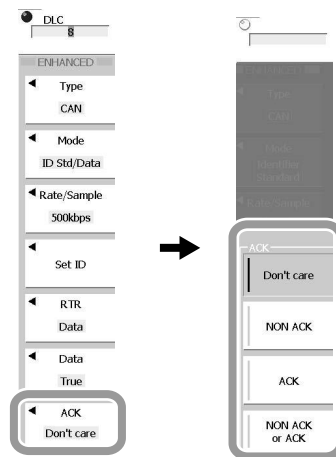

### If You Selected ID/Data OR in Step 5

#### Setting the ID/Data for the OR Condition

30. Press the **ID/Data 1**, **ID/Data 2**, **ID/Data 3**, or **ID/Data 4** soft key to select the **ID/Data** on which to set the OR condition.
31. Press the **ID/Data X** soft key (where X is a number between 1 and 4) to select ON (include in the OR condition) or OFF (not include in the OR condition).
32. Press the **Format** soft key to set the ID format to Std (standard format) or Ext (extended format).

The subsequent steps are the same as when you select ID Std/Data or ID Ext/Data in step 5. For the procedure, see steps 11 to 29 on page 6-87.

To activate a trigger on the OR condition of multiple ID/Data, repeat steps 30 to 32.

Proceed to step 33.

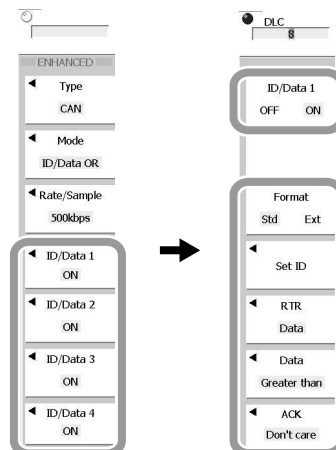

## Setting the Source Channel

33. Press **SOURCE**. The SOURCE menu appears.

### Selecting the Source Channel

34. Press the **Source** soft key. A menu used to select the source channel of the CAN bus signal appears.
35. Press any of the soft keys **CH1** to **CH4** to select the source channel.

### Selecting the Bus Level

36. Press the **Recessive** soft key to select H (set the recessive electric potential higher than the dominant electric potential) or L (set the recessive electric potential less than the dominant electric potential).

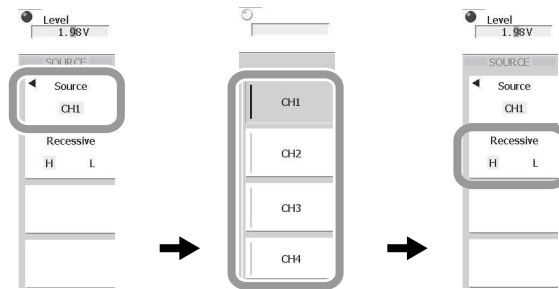

### Setting the Level, Coupling, HF Rejection, and Hysteresis

37. Press **LEVEL/COUPLING**. The LEVEL/COUPLING menu appears.

#### Selecting the Channel to Be Configured

- 38. Press the **CH** soft key. The menu used to select the channel appears.
- 39. Press any of the soft keys, **CH1** to **CH4**.

#### Setting the Level

- 40. Turn the **rotary knob** to set the level used to determine high/low.

#### Selecting the Coupling

- 41. Press the **Coupling** soft key to select DC.

#### Selecting the HF Rejection

- 42. Press the **HF Rejection** soft key. The menu used to select the HF rejection appears.
- 43. Press the **OFF**, **20MHz**, or **15kHz** soft key.

#### Selecting the Hysteresis

- 44. Press the **Hysteresis** soft key to select the hysteresis.

As necessary, repeat steps 38 to 44.

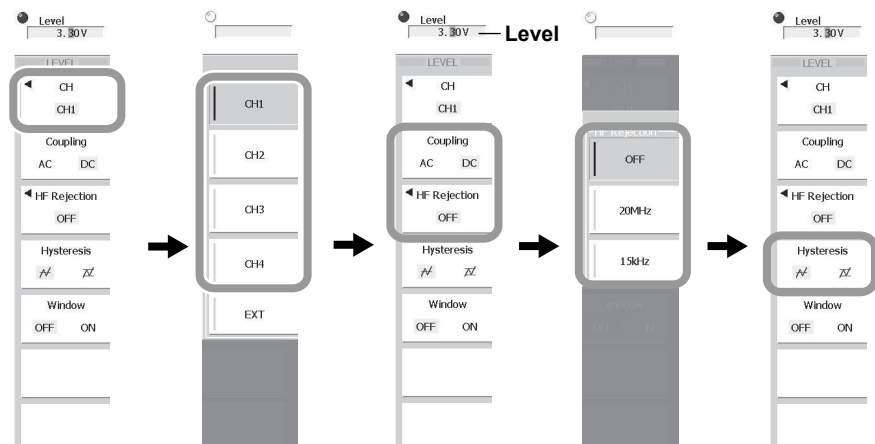

**Explanation**

By setting the ID bit pattern, DLC, Data, and ACK slot status of the CAN bus, a trigger can be activated on a specific data frame or remote frame. This function can be used on products with firmware version 2.00 or later.

CAN stands for Controller Area Network. It is a serial communication protocol standardized internationally by the ISO (International Organization for Standardization). Note that the /F7 or /F8 option is required for analysis of CAN bus signals.

**High Speed CAN (ISO11898) and Low Speed CAN (ISO11519-2)**

Two typical standards of the CAN physical layer are High speed CAN (ISO11898) and Low speed CAN (ISO11519-2).

In the figure below, the bus level is determined for both High and Low speed CAN according to the difference of potential between the CAN\_High and CAN\_Low busses.

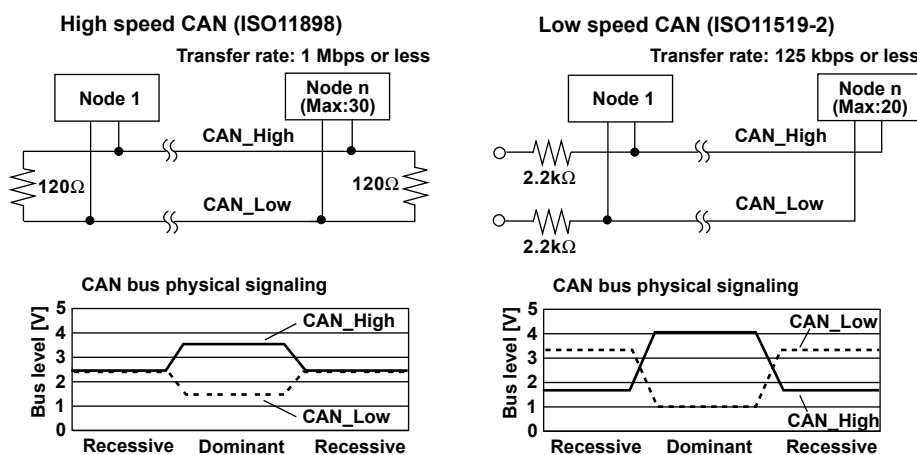
**Connecting the Probe****Probe to Be Used**

A differential probe is used when measuring CAN bus signals.

Compatible differential probes: 701920 and 701922 by Yokogawa

**Probe Connection Procedure**

When displaying the recessive voltage level higher than the dominant voltage level (Recessive: H)

- **For a two wire system (differential)**  
Connect the differential probe negative (–) to CAN\_High, and the probe positive (+) to CAN\_Low.
- **For a one wire system (single-ended)**  
Connect the differential probe negative (–) to CAN\_High, and probe positive (+) to GND (ground potential).

When displaying the recessive voltage level less than the dominant voltage level (Recessive: L)

- **For a two wire system (differential)**  
Connect the differential probe negative (–) to CAN\_Low, and the probe positive (+) to CAN\_High.
- **For a one wire system (single-ended)\***  
Connect the differential probe negative (–) to GND (ground potential), and probe positive (+) to CAN\_High.

\* In this case, the passive probe (model 700988) can be connected to CAN\_High.



## Setting the Trigger Conditions of the CAN Bus Signal

### Trigger Mode

The following trigger modes are available.

SDF	Activate a trigger on the Start of Frame (SOF).
Error Frame	Activate a trigger on an error frame.
ID Std/Data	Activate a trigger on a data frame or remote frame (ID: standard format) that matches the specified conditions.
ID Ext/Data	Activate a trigger on a data frame or remote frame (ID: extended format) that matches the specified conditions.
ID/Data OR	Activate a trigger on the OR condition of four types of data frames or remote frames. You can select standard or extended format for each ID.

For details on the trigger point for each trigger mode, see page 6-98.

### Bitrate

Select the transfer rate of the CAN bus signal from 1Mbps, 500kbps, 250kbps, 125kbps, 83.8kbps, 33.3kbps (33.3kbps supported by firmware version 2.40 or later), and User. If you select User, you can set an arbitrary value in the range of 10k to 1M [bps] (0.1 kbps resolution).

### Sample Point

Set the point used to judge the bus level (recessive or dominant) in the range of 18.8 to 90.6 [%].

In the trigger circuits of the instrument's CAN bus signal analysis function, the input CAN bus signal is sampled once per the internal clock, and the point of change from recessive to dominant is detected. The detected point is taken as 0%, and the point one bit time (the reciprocal of the specified bit rate) thereafter is taken as 100%, allowing expression of the sample point as a percentage.

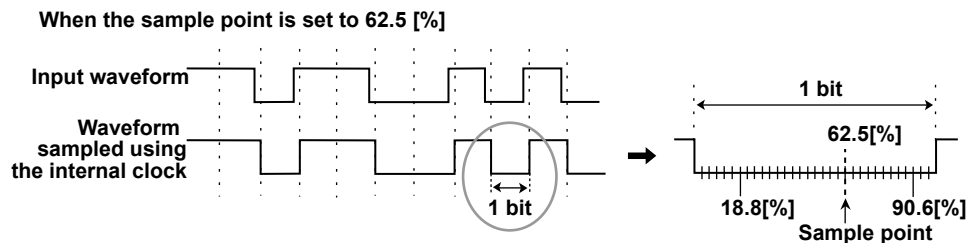

**When the Trigger Mode Is Set to ID Std/Data or ID Ext/Data****ID Bit Pattern (Set ID)**

Set an 11-bit ID pattern if you select ID Std/Data or a 29-bit pattern if you select ID Ext/Data. Binary bit patterns are set using 0, 1, and X. Hexadecimal bit patterns are set using 0 to 9, A-F, and X. Matching of the specified ID bit pattern is a trigger condition.

**Note**

- If an ID bit pattern is set to X, the condition is assumed to be met regardless of the status of the corresponding bit.  
Binary: Condition met on either 0 or 1  
Hexadecimal: Condition met on any value (0 to 9 and A to F)
- If there is at least one "X" bit in a group of four bits of the ID bit pattern in the binary display, the corresponding hexadecimal display will show a "\$".

**Remote Frame or Data Frame (RTR)**

A trigger can be activated on the combination of remote frames or data frames and the ID bit pattern.

Don't care	Remote frames and data frames are used as trigger conditions.
Remote	Remote frames are used as trigger conditions.
Data	Data frames are used as trigger conditions

The items below are set only when RTR is set to Data.

• **DLC**

Set the DLC (number of valid bytes) of the data field in the range of 0 to 8 bytes. The default value is 8 bytes.

• **Data Field Condition**

Select the data condition when using the data field as a trigger condition from the following:

Don't care	A trigger is activated when the DLC matches.
True	A trigger is activated when Data in the data field matches the specified bit pattern.
False	A trigger is activated when Data in the data field does not match the specified bit pattern.
Greater/Equal	A trigger is activated when Data in the data field is greater than or equal to the specified comparison data.
Less/Equal	A trigger is activated when Data in the data field is less than or equal to the specified comparison data.
Between	A trigger is activated when Data in the data field is greater than or equal to the specified comparison data Data1, and less than or equal to the comparison data Data2.
Out of Range	A trigger is activated when Data in the data field is less than the specified comparison data Data1, or greater than the comparison data Data2.

If Data1 is set equal to Data2 for Between, a trigger is activated when the data of the data field is equal to Data1 which is equal to Data2.

**Data Bit Pattern (Set Data)**

Set the bit pattern only when Condition is set to True or False.

Set the Data bit pattern. Binary bit patterns are set using 0, 1, and X. Hexadecimal bit patterns are set using 0 to 9, A-F, and X. The length of the bit pattern is the number of bytes set by DLC.

**6.20 Setting the Trigger Conditions of the CAN Bus Signal (ENHANCED)**

**Note**

- If an Data bit pattern is set to X, the condition is assumed to be met regardless of the status of the corresponding bit.  
 Binary: Condition met on either 0 or 1  
 Hexadecimal: Condition met on any value (0 to 9 and A to F)
- If there is at least one "X" bit in a group of four bits of the Data bit pattern in the binary display, the corresponding hexadecimal display will show a "\$".

**Comparison Data**

Set the items below if Condition is set to Greater/Equal, Less/Equal, Between, or Out of Range.

• **Data, Data1, and Data2**

Set the value (Data, Data1, and Data2) that is compared against the Data in the data field in decimal notation. Set Data for Greater/Equal or Less/Equal. Set Data1 and Data2 for Between or Out of Range.  
 For the selectable ranges of Data, Data1, and Data2, see "Sign" below.

• **Byte Order**

Set the byte read order of the Data, Data1, and Data2 to Big Endian or Little Endian.  
 For example, when a node transmits four-byte data (12345678: hexadecimal notation), the image of the frame on the bus is as shown in the following figure.

• **Big Endian**

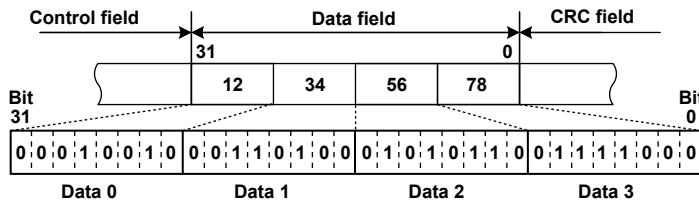

• **Little Endian**

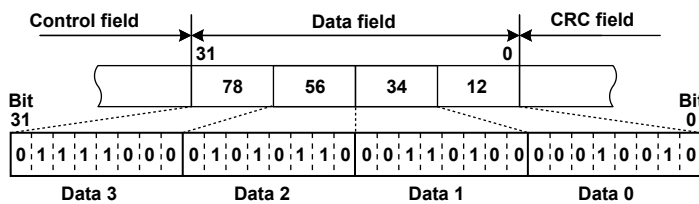

• **Sign**

Select whether to make Data, Data1, and Data2 signed numbers.  
 The selectable range of Data, Data1, and Data2 when you select Sign or Unsign is shown below.

Sign	-9E+18 to 9E+18
Unsign	0 to 9E+18

The Data, Data1, and Data2 values are displayed using exponential notation when the values exceed seven digits (example: 1234567E+10).

## 6.20 Setting the Trigger Conditions of the CAN Bus Signal (ENHANCED)

- **MSB/LSB**

Set the bit positions of Data, Data1, and Data2 to be compared using MSB and LSB. The selectable range is 0 to 63 (the selectable range may be limited depending on the DLC setting).

For example, to compare only bits 5 to 20 of the four-byte data (12345678: hexadecimal notation), set LSB to 5 and MSB to 20. The bits of the data field that are compared for this case are as shown in the figure below for the different byte order settings (Big Endian and Little Endian).

- **Big Endian**

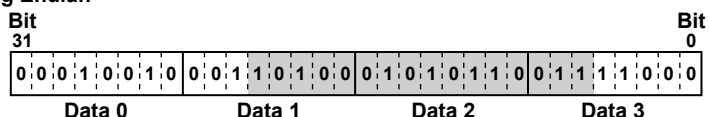

- **Little Endian**

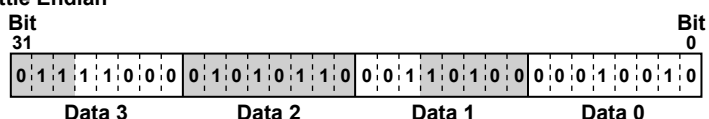

### Note

Relationship between the DLC, MSB, LSB, Data, Data1, and Data2 values  
The relationship between the DLC, MSB, LSB, Data, Data1, and Data2 values is shown below.

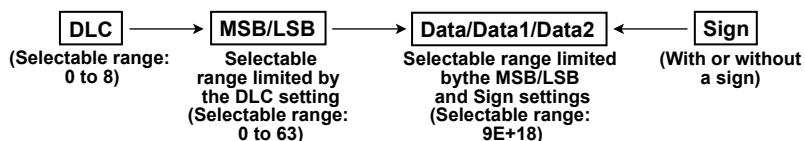

[Example] When DLC is set to 2 bytes  
 $0 \leq \text{LSB} \leq \text{MSB} \leq 15$  (equivalent to 2 bytes)  
 • Sign (signed number):  $-32768 \leq \text{Data1} \leq \text{Data2} \leq 32767$   
 • Unsign (unsigned number):  $0 \leq \text{Data1} \leq \text{Data2} \leq 65535$

### ACK Slot

The bus level of the ACK slot (recessive or dominant) can be used as a trigger condition.

Don't care	The bus level of the ACK slot is not used as a trigger condition.
NON ACK	A trigger is activated when the bus level of the ACK slot is recessive.
ACK	A trigger is activated when the bus level of the ACK slot is dominant.
NON ACK or ACK	A trigger is activated when the bus level of the ACK slot is recessive or dominant.

### Note

If you set the trigger mode to ID/Data OR and set the ACK slot to Don't care, set the ACK slot of all data frames or remote frames (ID/Data1 to ID/Data4) to Don't care.  
The trigger may not be activated in the correct position, if you mix Don't care and other settings (NON ACK, ACK, NONACK or ACK).

**When the Trigger Mode Is Set to ID/Data OR**

**IDs Take the OR Logic (Edit Condition)**

Set four trigger conditions (ID/Data1 to ID/Data4) of data frames or remote frames. You can enable or disable each ID/Data condition. You can select standard or extended format for each ID.

**ID Format**

Set the ID format to Std (standard format) or Ext (extended format).

**ID Bit Pattern (Set ID)**

The details are the same as when the trigger mode is set to ID Std/Data or ID Ext/Data. For details, see page 6-95.

**Remote Frame or Data Frame (RTR)**

The details are the same as when the trigger mode is set to ID Std/Data or ID Ext/Data. For details, see page 6-95.

**ACK Slot**

The details are the same as when the trigger mode is set to ID Std/Data or ID Ext/Data. For details, see page 6-97.

**Source Channel**

The source channel of the CAN bus signal is set using the SOURCE menu that appears when you press the SOURCE key. The menu used to set the source channel of the CAN bus signal appears only when Type is set to CAN in the ENHANCED menu.

**Specifying the Source Channel**

The source channel is specified using the SOURCE menu.

**Bus Level (Recessive)**

Select the bus level from either of the following: In either case, the logical value is: recessive = 1 and dominant = 0.

---

H	The recessive electric potential is set higher than the dominant electric potential.
L	The recessive electric potential is set lower than the dominant electric potential.

---

**Trigger Level, Trigger Coupling, Etc.**

Set the trigger level, trigger coupling, HF rejection, and hysteresis of each channel. For details on these items, see section 6.3.

## Frame Format and Trigger Point

The following figure shows the format and trigger point of each frame.

### Data Frame

#### • Standard format

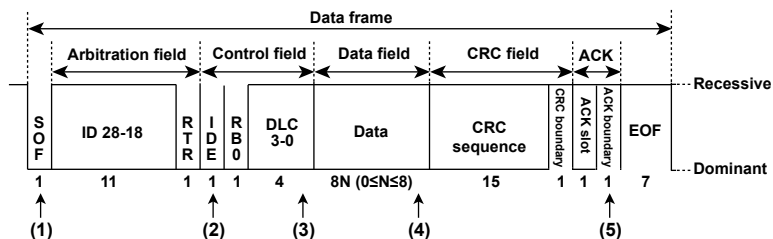

#### • Extended format

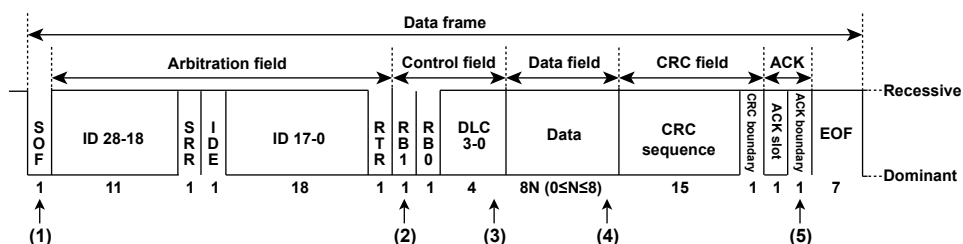

Items (1) to (5) above are the trigger points for the following conditions.

- (1) Mode: SOF
- (2) Mode: ID X\*, RTR: Don't care, and ACK: Don't care
- (3) Mode: ID X\*, RTR: Data, Condition: Don't care, and ACK: Don't care
- (4) Mode: ID X\*, RTR: Data, Condition: Other than Don't care, ACK: Don't care
- (5) ACK: Other than Don't care

\* ID X: For ID Std/Data, ID Ext/Data, or ID/Data OR

### Remote Frame

#### • Standard format

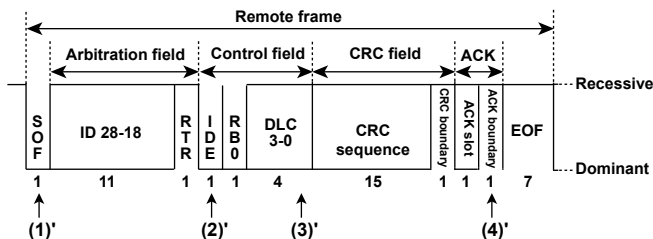

#### • Extended format

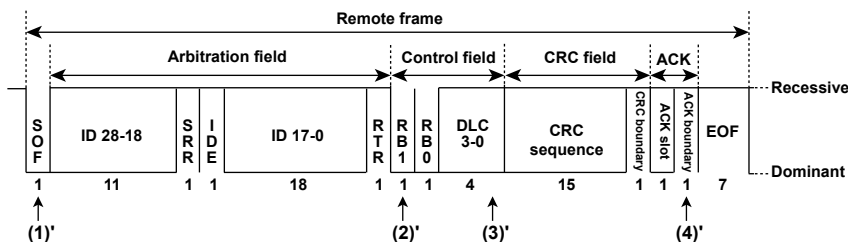

Items (1) to (5) above are the trigger points for the following conditions.

- (1)' Mode: SOF
- (2)' Mode: ID X\*, RTR: Don't care, ACK: Don't care
- (3)' Mode: ID X\*, RTR: Remote, ACK: Don't care
- (4)' ACK: Other than Don't care

\* ID X: For ID Std/Data, ID Ext/Data, or ID/Data OR

## 6.20 Setting the Trigger Conditions of the CAN Bus Signal (ENHANCED)

---

### Error Frame

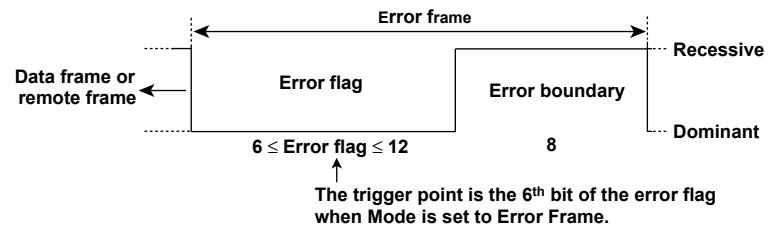

## 6.21 Setting the Trigger Conditions of the LIN Bus Signal (ENHANCED)

This function can be used on products with firmware version 2.40 or later.

### Procedure

#### Setting the Trigger Conditions of the LIN Bus Signal

1. Press **ENHANCED**. The ENHANCED menu appears.
2. Press the **Type** soft key. The trigger type selection menu appears.
3. Press the **LIN** soft key.

#### Setting the Bitrate

4. Press the **Bitrate** soft key. The bit rate selection menu appears.
5. Press the **19200 bps**, **9600 bps**, **4800 bps**, **2400 bps**, **1200 bps**, or **User** soft key to select the bit rate. If you select User, turn the rotary knob to set an arbitrary value.

#### Note

The trigger mode is fixed to Break.

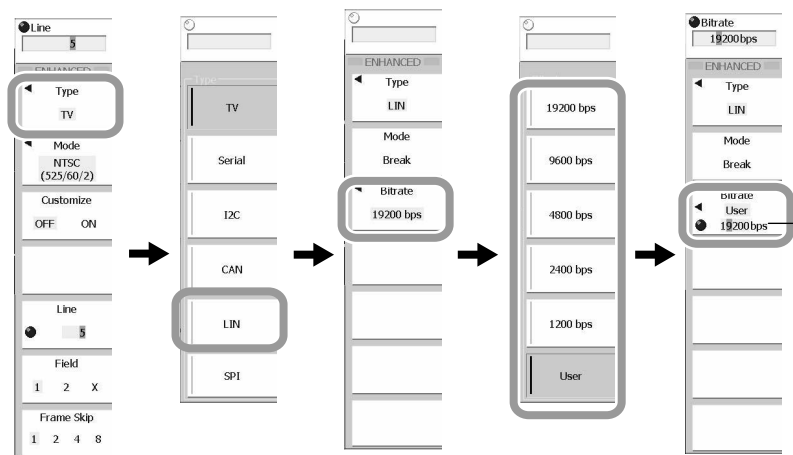

Displayed only when User is selected.



## 6.21 Setting the Trigger Conditions of the LIN Bus Signal (ENHANCED)

### Setting the Source Channel

6. Press **SOURCE**. The SOURCE menu appears.
7. Press the **Source** soft key. A menu used to select the source channel of the LIN bus signal appears.
8. Press any of the soft keys from **CH1** to **CH4** to select the source channel.

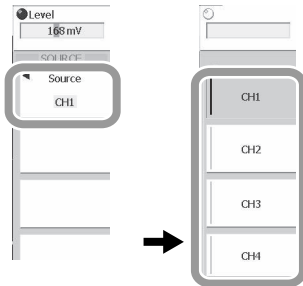

### Setting the Level, Coupling, HF Rejection, and Hysteresis

9. Press **LEVEL/COUPLING**. The LEVEL/COUPLING menu appears.

#### Selecting the Channel to Be Configured

10. Press the **CH** soft key. The menu used to select the channel appears.
11. Press any of the soft keys, **CH1** to **CH4**.

#### Setting the Level

12. Turn the **rotary knob** to set the level used to determine high/low.

#### Selecting the Coupling

13. Press the **Coupling** soft key to select DC.

#### Selecting the HF Rejection

14. Press the **HF Rejection** soft key. The menu used to select the HF rejection appears.
15. Press the **OFF**, **20MHz**, or **15kHz** soft key.

#### Selecting the Hysteresis

16. Press the **Hysteresis** soft key to select the hysteresis.

As necessary, repeat steps 10 to 16.

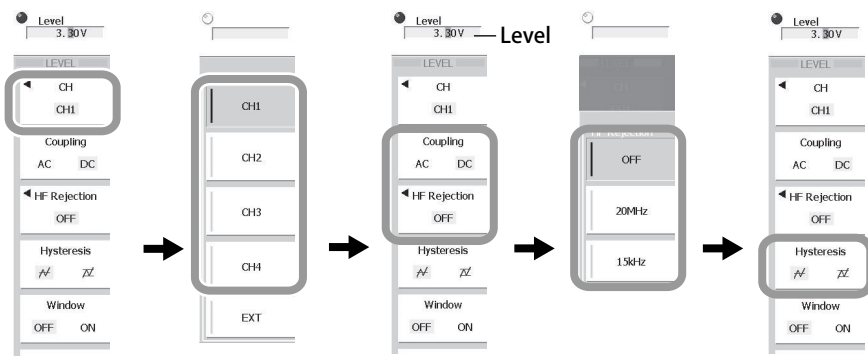

**Explanation**

LIN stands for Local Interconnect Network. This function can be used on products with firmware version 2.40 or later.

It is a serial communication protocol used mainly for automobiles and other vehicles. Note that the /F7 or /F8 option is required for analysis of LIN bus signals.

**Setting the Trigger Conditions of the LIN Bus Signal****Trigger Mode**

The trigger mode is fixed to Break.

The trigger activates on the rising edge of the Break delimiter of the LIN bus signal.

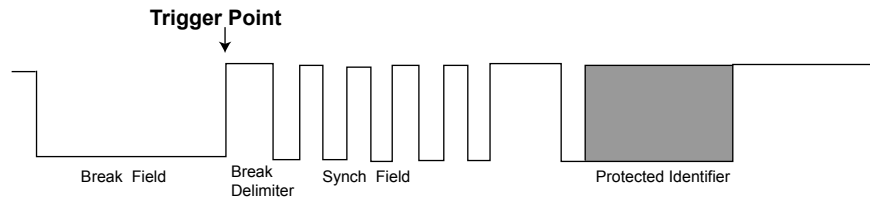
**Bitrate**

Select the transfer rate of the LIN bus signal from 19200bps, 9600bps, 4800bps, 2400bps, 1200bps, or User. If you select User, you can set an arbitrary value in the range of 1000 bps–20 kbps (setting resolution: 10bps).

**Source Channel**

The source channel of the LIN bus signal is set using the SOURCE menu that appears when you press the SOURCE key. The menu used to set the source channel of the LIN bus signal appears only when Type is set to LIN in the ENHANCED menu.

**Specifying the Source Channel**

The source channel is specified using the SOURCE menu.

**Trigger Level, Trigger Coupling, Etc.**

Set the trigger level, trigger coupling, HF rejection, and hysteresis of each channel. For details on these items, see section 6.3.

## 6.22 Setting the Trigger Conditions of the SPI Bus Signal (ENHANCED)

This function can be used on products with firmware version 1.60 or later.

### Procedure

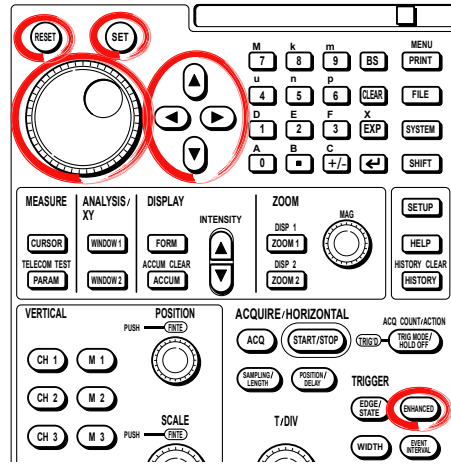

### Setting the Trigger Conditions of the SPI Bus Signal

1. Press **ENHANCED** to display the ENHANCED menu.
2. Press the **Type** soft key to display the Type menu.
3. Press the **SPI** soft key.

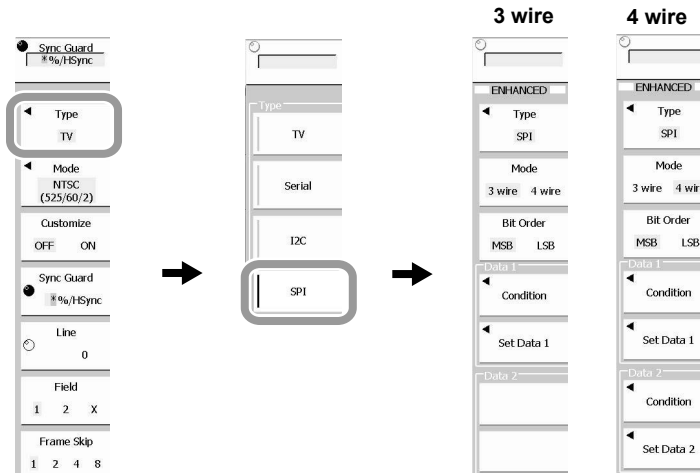

**Selecting Three-Wire or Four-Wire and Selecting the Bit Order**

4. Press the **Mode** soft key to select 3 wire or 4 wire.
5. Press the **Bit Order** soft key to set the read direction of the I/O data bits to MSB (MSB first) or LSB (LSB first).

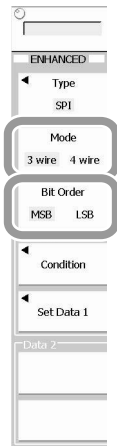

**Setting the Data Conditions**

• **Setting the Conditions**

6. Press the **Condition** soft key to display a menu used to set the condition and data size.
7. Press the **Condition** soft key to select True (match the specified bit pattern) or False (not match the specified bit pattern).
8. Press a soft key corresponding to the data size of the bit pattern (a trigger condition).
9. To activate a trigger the specified number of bytes after the assertion of the CS, use the **rotary knob** to set the trigger position (data position).

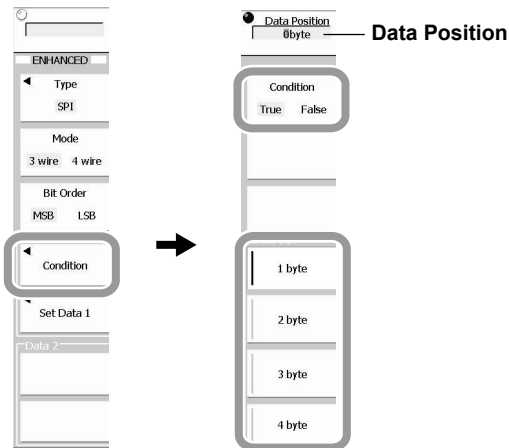

10. For four-wire, set the condition and data size for Data 2 in the same manner.
11. Press **ESC** to return to the previous screen.

## 6.22 Setting the Trigger Conditions of the SPI Bus Signal (ENHANCED)

- **Setting the Bit Pattern**

12. Press the **Set Data 1** soft key to display the bit pattern setting screen.
13. Turn the **rotary knob**, **arrow** keys, and **SET** key to set the pattern.  
You can use the soft keys to change the format to binary or hexadecimal or clear all the bits (X).

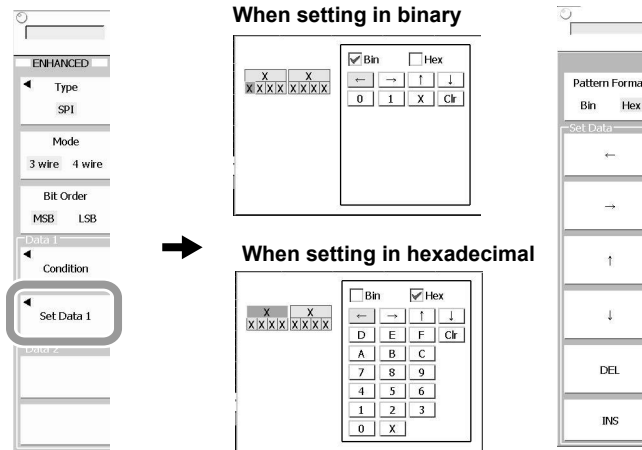

14. Press **ESC** to return to the previous screen.
15. For four-wire, set the bit pattern for Data 2 in the same manner.

### Setting the Source Channel

16. Press **SOURCE** to display the SOURCE menu.

- **Setting the CS**

17. Press the **Source** soft key under CS to display the CS source channel selection menu.
18. Press any of the soft keys **CH1** to **CH4** to assign the channel to the CS.
19. Press the **Active** soft key to select H (high) or L (low).

- **Setting the Clock**

20. Press the **Source** soft key under Clock to display the clock source channel selection menu.
21. Press any of the soft keys **CH1** to **CH4** to assign the channel to the clock channel.
22. Press the **Polarity** soft key to select rising or falling.

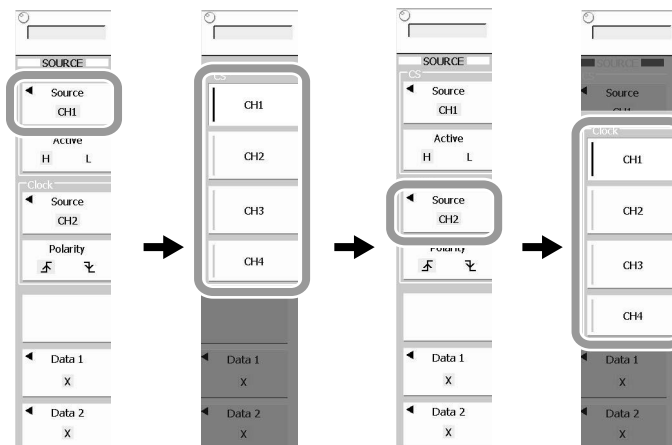

• **Select the Channel for Comparing the Bit Pattern**

23. Press the **Data 1** soft key to display a menu used to select the channel to compare to the bit pattern of Data 1.
24. Press any of the soft keys, **CH1** to **CH4**.
25. For four-wire, select the channel for comparing the bit pattern for Data 2 in the same manner.

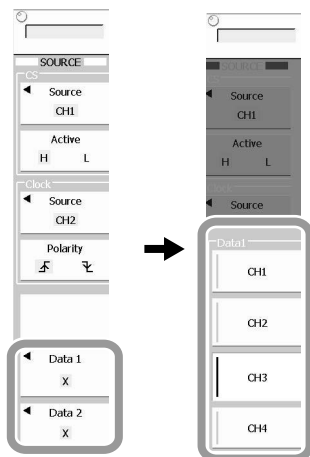

**Setting the Level, Coupling, HF Rejection, and Hysteresis**

26. Press **LEVEL/COUPLING**. The LEVEL/COUPLING menu appears.

**Selecting the Channel to Be Configured**

27. Press the **CH** soft key. The menu used to select the channel appears.
28. Press any of the soft keys, **CH1** to **CH4**.

**Setting the Level**

29. Turn the **rotary knob** to set the level used to determine high/low.

**Selecting the Coupling**

30. Press the **Coupling** soft key to select DC.

**Selecting the HF Rejection**

31. Press the **HF Rejection** soft key. The menu used to select the HF rejection appears.
32. Press the **OFF**, **20MHz**, or **15kHz** soft key.

**Selecting the Hysteresis**

33. Press the **Hysteresis** soft key to select the hysteresis.

As necessary, repeat steps 24 to 30.

**Explanation**

This is a trigger function for capturing SPI bus signals. This function can be used on products with firmware version 1.60 or later.

The SPI (Serial Peripheral Interface) Bus is a synchronized serial bus that is widely used for inter-IC communications and data communications. Note that the /F5 option is required to analyze SPI bus signals.

**Setting Three-Wire or Four-Wire**

For three-wire, triggers are activated on the Data 1 bit pattern.

For four-wire, triggers are activated on the Data 1 and Data 2 bit patterns. The Data 1 and Data 2 data patterns can also be used as independent trigger conditions.

**Bit Order**

You can select the bit order of Pattern A and Pattern B according to the signal flow of the input/output data. When setting the pattern in binary, set the data in the order of the flow regardless of the bit order setting. When setting the pattern in hexadecimal, enter the pattern according to the bit order setting, separated every four bits in the order of the flow.

MSB	Select this when the I/O data signal is flowing MSB first.
LSB	Select this when the I/O data signal is flowing LSB first.

**Setting the Bit Pattern**

• **Condition**

Select either of the following:

True	A trigger is activated when the data matches the specified bit pattern.
False	A trigger is activated when the data does not match the specified bit pattern.

• **Data Size**

Select the number of bytes (data length) of bit pattern to be specified in the range of 1 to 4 bytes.

• **Data Position**

Compares the pattern the specified number of bytes after the assertion of the chip select (CS). The data position can be set separately for Data 1 and Data 2. The selectable range is 0 to 9999.

• **Pattern Format**

Set the bit pattern format to either of the following:

Hex	Hexadecimal
Bin	Binary

• **Bit Pattern**

Set the bit pattern. When Pattern Format is set to Hex (hexadecimal), you can enter X, 0 to 9, or A to F in units of 4 bits. When Pattern Format is set to Bin (binary), you can enter X, 0, or 1 for each bit.

**Setting the Chip Select**

Select the CS from CH1 to CH4. Select whether to make the signal active when it is high or low with the Active item.

**Clock Signal**

Select the input signal to be the clock signal from CH1 to CH4.

The bit pattern is compared on the rising or falling edge of the signal.

### Setting the Channel for Comparing the Bit Pattern

Select the signal for comparing the bit pattern from CH1 to CH4.

### Setting the Trigger Level, Trigger Coupling, Etc.

Set the trigger level, hysteresis, trigger coupling, and HF rejection of each channel. For details on the trigger level, hysteresis, trigger coupling, and HF rejection, see section 6.3.

### Examples of SPI Bus Signal Trigger Conditions

The trigger point is set to the position indicated below depending on the clock edge polarity setting (see page 6-105).

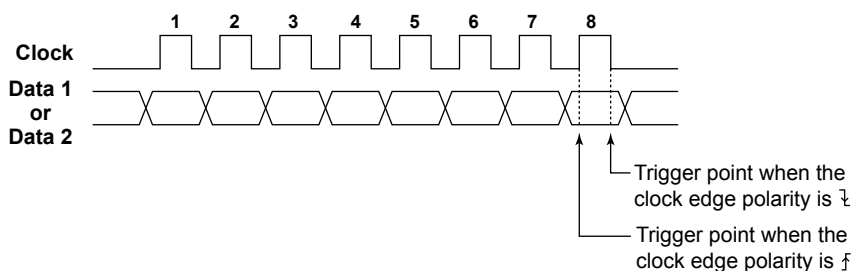

This section will display the data sequence in bytes in hexadecimal notation and indicate the position where the trigger will occur.

The shaded section is the figure indicates the byte pattern (sequence) that is compared.

We assume that CH1 is selected for comparing the bit pattern of Data 1 and CH2 is selected for comparing that of Data 2.

### Trigger Conditions

CS	L
Data 1	A4 and 25, Data Byte: 2, Condition: True, and Byte Position: 0
Data 2	85 and C8, Data Byte: 2, Condition: True, and Byte Position: 6

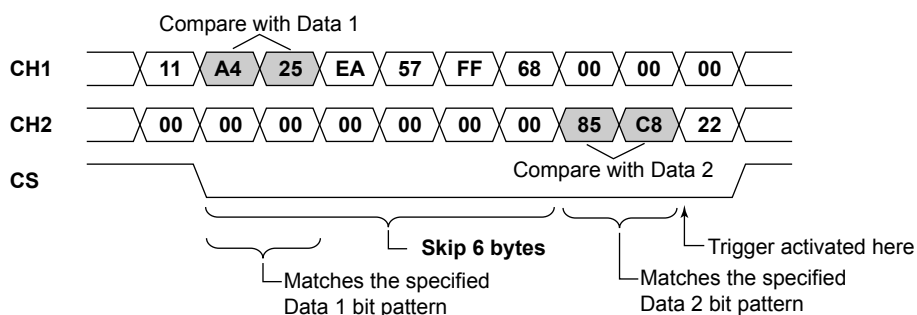



## 6.23 Trigger Settings of the Serial Bus Signal That Are Common to the Settings of the Serial Bus Signal Analysis and Search

The trigger settings of the serial bus signal on the menu that is entered through the ENHANCED key and the settings of the serial bus signal analysis and search on the menu entered through the WINDOW1, ZOOM1, or M1 (M1 is applicable only for CAN bus signal) key are common. The CH1 to CH4 sources are the waveforms of which the settings are common. The analysis and search functions of the I<sup>2</sup>C bus, CAN bus, and SPI bus signals are options.

### When the target is Serial

---

Bitrate, Clock ON/OFF, Data Source, Data Active, CS ON/OFF, Clock Source, Clock Polarity, Latch Source, and Latch Polarity (Serial only has trigger and search settings.)

---

### When the target is I<sup>2</sup>C bus signal

---

**Trigger settings of the I<sup>2</sup>C bus signal that are applied to the settings of both the I<sup>2</sup>C bus signal analysis and search**

---

Level (trigger level), Hysteresis (trigger hysteresis)

(The settings of the I<sup>2</sup>C bus signal analysis and search are not applied to the trigger settings of the I<sup>2</sup>C bus signal.)

---

**Item for which the trigger settings, analysis settings, and search settings of the I<sup>2</sup>C bus signal that are mutually applied**

---

SDA Source, SCL Source

---

### When the target is CAN bus signal

---

**Trigger settings of the CAN bus signal that are applied to the settings of CAN bus signal analysis, search, and stuff bit computation**

---

Level (trigger level), Hysteresis (trigger hysteresis), and Sample Point

(The settings of the CAN bus signal analysis, search, and stuff bit computation are not applied to the trigger settings.)

---

**Items for which the trigger settings, analysis settings, search settings, and stuff bit computation settings of the CAN bus signal are applied mutually**

---

Source, Bitrate, and Recessive

---

### When the target is LIN bus signal

---

**Trigger settings of the LIN bus signal that are applied to the settings of both the LIN bus signal analysis and search**

---

Level (trigger level), Hysteresis (trigger hysteresis), and Sample Point

(The settings of the LIN bus signal analysis and search are not applied to the trigger settings.)

---

**Items for which the trigger settings, analysis settings and search settings of the LIN bus signal are applied mutually**

---

Source, Bitrate

---

### When the target is SPI bus signal

---

**Trigger settings of the SPI bus signal that are applied to the settings of both the SPI bus signal analysis and search**

---

Level (trigger level), Hysteresis (trigger hysteresis)

(The settings of the SPI bus signal analysis and search are not applied to the trigger settings of the SPI bus signal.)

---

**Item for which the trigger settings, analysis settings, and search settings of the SPI bus signal are applied mutually**

---

Mode(3wire/4wire), Bit Order, CS Source, CS Active, Clock Source, Clock Polarity, Data1, Data2

---

### Note

#### When the target is Serial, I<sup>2</sup>C bus, or SPI bus signal

- M1 to M4 are does not apply to the common settings.
- The settings of the serial bus signal analysis and search on the menu entered through the WINDOW2 and ZOOM2 keys are not made common. They are independent settings.
- If you change common items (excluding Level and Hys) in the analysis and search menus while the waveform acquisition is in progress and the trigger type is set to serial, the waveform acquisition is restarted.
- The level and hysteresis settings are common to all types for analysis and search. Even if something other than serial bus is selected in the analysis or search menu, the level and hysteresis settings of the analysis and search are set to the same value if the trigger level or hysteresis setting is changed.
- When the trigger level or hysteresis is changed by executing auto setup, the level and hysteresis settings of the analysis and hysteresis are also set to the same new value. This also applies when the setup information is initialized.
- Trigger hysteresis  $\overline{\Delta}$  and  $\overline{\nabla}$  correspond to 0.6 division and 1.0 division, respectively, of the analysis or search.

#### When the target is CAN bus signal

- The settings of the CAN bus signal analysis, search, and stuff bit computation on the menu entered through the WINDOW2, ZOOM2, and M2 to M4 keys are not made common. They are independent settings.
- If you change common items (excluding Level, Hys, and Sample Point) in the analysis, search, and stuff bit computation menus while the waveform acquisition is in progress and the trigger type is set to CAN, the waveform acquisition is restarted.
- The level and hysteresis settings are common to all types for analysis and search. Even if something other than CAN bus is selected in the analysis or search menu, the level and hysteresis settings of the analysis and search menus are set to the same value if the level or hysteresis setting is changed.
- If the trigger level or hysteresis is changed by executing auto setup, the level and hysteresis settings of the analysis and search are also set to the same new value. This also applies when the setup information is initialized.
- Trigger Hys  $\overline{\Delta}$  and  $\overline{\nabla}$  correspond to 0.6 division and 1.0 division, respectively, of the analysis, search, or stuff bit computation.

# 7.1 Setting the Acquisition Mode

## Procedure

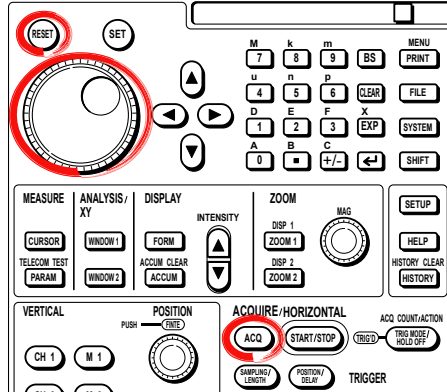

### Setting the Acquisition Mode

1. Press **ACQ**. The mode selection menu appears.
2. Press the soft key that corresponds to the desired setting, from **Normal**, **Envelope**, and **Average**.

### Setting the Number of Data Acquisitions for a Simple Average (When Mode is Average and the Trigger Mode is Single)

3. Use the **rotary knob** to set the number of waveform acquisitions.

### Setting the Damping Constant for a Sliding Average (When Mode is Average and the Trigger Mode is Auto, Auto Level or Normal)

4. Use the **rotary knob** to set the attenuation constant (Weight). The selectable range is 2 to 1024.

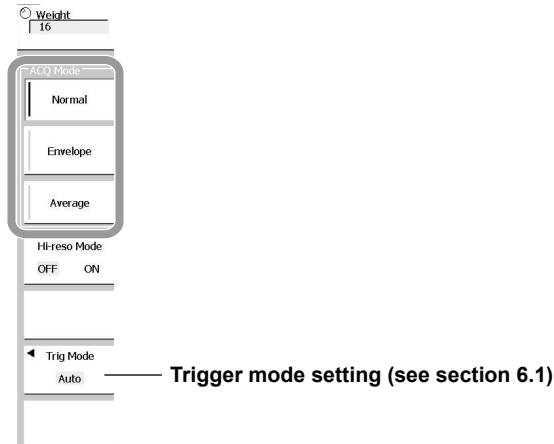

**Explanation**

**Selecting the Acquisition Mode: Mode**

You can select the acquisition mode from the following. The default setting is Normal.

- **Normal Mode**  
Sampled data is stored in the acquisition memory without special processing.
- **Envelope Mode**  
The maximum and minimum values are determined every acquisition interval from the data sampled at 2.5 GS/s (DL9040/DL9040L/DL9140/DL9140L) or 5 GS/s (DL9240/DL9240L). The maximum and minimum values are stored in the acquisition memory and an envelope waveform is displayed.
- **Averaging Mode**  
Sampled data is averaged and stored to the acquisition memory. The averaging method varies depending on the trigger mode setting.  
Exponential averaging is enabled when the trigger mode is Auto, Auto Level or Normal. You can set the concentration in a range of 2 to 1024.  
Simple averaging is enabled when the trigger mode is Single or N-Single. Set the averaging count to a range of 2 to 65536. If set to N-Single, you can specify the average count by setting the N item on the trigger mode setting menu.

- **Exponential average**  
(when trigger is set to Auto / Auto Level / Normal)

$$A_n = \frac{1}{N} \{(N-1)A_{n-1} + X_n\}$$

A<sub>n</sub>: nth averaged value  
X<sub>n</sub>: nth measured value  
N: Attenuation (2 to 1024, 2<sup>n</sup> steps)

- **Simple average**  
(when trigger is set to Single / N-Single)

$$A_N = \frac{\sum_{n=1}^N X_n}{N}$$

X<sub>n</sub>: nth measured value  
N: Average count (acquisition count, 2<sup>n</sup> steps)

**Precautions when Averaging**

- Averaging is effective only for repetitive waveforms.
- Correct averaging is not possible if the waveform has imperfect triggering (incomplete synchronization), and the displayed waveform will be distorted.
- Roll mode display is disabled when averaging is used.
- If you stop waveform acquisition by pressing START/STOP, the averaging process also stops. Averaging restarts from the beginning when acquisition resumes.
- If you are using simple averaging, the DL9000 terminates acquisition automatically when it completes the specified number of acquisitions (acquisition count).
- The following is data saved in the history memory when acquiring waveforms in the averaging mode.

When using exponential averaging (Trigger mode: Auto; Auto Level; or Normal)  
Saves averaging results for a specified amount of time in a multiple of records.

When using simple averaging (Trigger mode: Single)  
Saves the measurements of one time in one record.

When using simple averaging (Trigger mode: N-Single)  
N times of data specified by the trigger mode.

- The maximum length of records for which averaging is possible is 625 KW for DL9040/DL9140/DL9240, and 1.25 MW for DL9040L/DL9140L/DL9240L.

## 7.2 Turning ON/OFF the High Resolution Mode

### Procedure

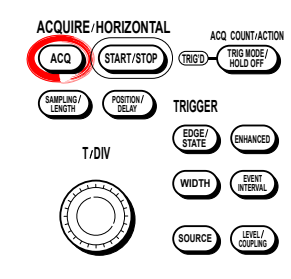

1. Press **ACQ**.
2. Press the **Hi-Res Mode** soft key to select ON or OFF.

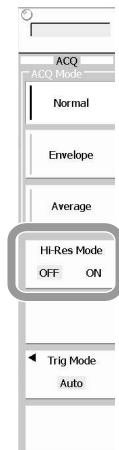

### Explanation

Bandwidth filter processing reduces the data quantization noise, allowing high-resolution data, exceeding 8 bits, to be handled. Normally, data is saved in the acquisition memory as 8-bit data so high resolution data that exceeds 8 bits is lowered to 8 bits for saving. By turning high resolution mode ON, data can be stored using 16-bit data (effective number of bits is 12). This allows high resolution data exceeding 8 bits to be stored without sacrificing the high resolution.

The maximum record lengths change for each instrument in the following way when high resolution mode is ON.

- 701307/701310/701312(DL9040/DL9140/DL9240): 2.5 MW → 1.25 MW
- 701308/701311/701313(DL9040L/DL9140L/DL9240L): 6.25 MW → 2.5 MW

Turning the high resolution mode ON when bandwidth limit is FULL will automatically set the instrument to a 200 MHz bandwidth limit.

## 7.3 Setting the Record Length

### Procedure

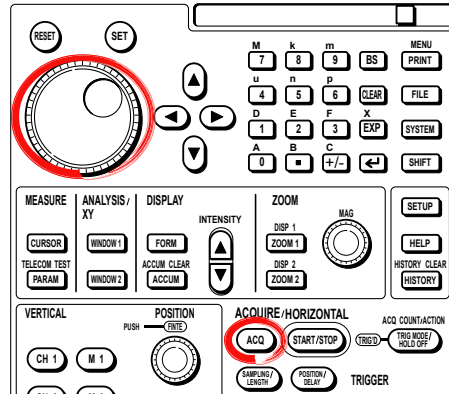

1. Press **SAMPLING/LENGTH**.
2. Use the **rotary knob** to set the record length. Press the soft key corresponding to the desired record length.

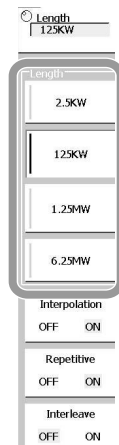

### Explanation

You can set the acquisition record length (the amount of data) to be stored to the acquisition memory.

2.5 k words; 6.25 k words; 12.5 k words; 25 k words; 62.5 k words; 125 k words; 250 k words; 625 k words; 1.25 M words; 2.5 M words; 6.25 M words (DL9040L/DL9140L/DL9240L)

## 7.4 Turning ON/OFF Repetitive Sampling Mode

### Procedure

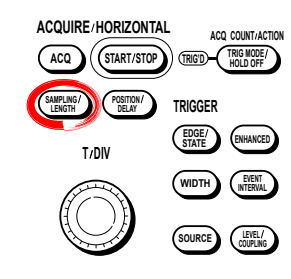

1. Press **SAMPLING/LENGTH**.
2. Press the **Repetitive** soft key to select ON or OFF.

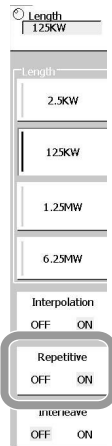

### Explanation

In the repetitive sampling mode, based in a trigger point in a repeating signal, a number of cycles of the data are sampled, yielding a higher apparent sample rate. If the repetitive sampling mode and interpolation are both ON, interpolation takes precedence at a sample rate less than 500 GS/s, and repetitive sampling mode takes precedence at a time axis setting less than or equal to 50 ns/div and a sample rate greater than or equal to 500 GS/s.

Even when the repetitive sampling mode is OFF, and interpolation is OFF, if the time axis setting is such that the record length is less than 100 points, waveforms are automatically acquired in the repetitive sampling mode.

#### Precautions for Repetitive Sampling

Exponential averaging is applied to the averaging of repetitive sampling. Simple averaging is not used the trigger mode is Single or N-Single.

## 7.5 Turning ON/OFF the Interleave Mode

### Procedure

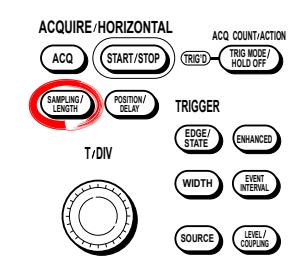

1. Press **SAMPLING/LENGTH**.
2. Press the **Interleave** soft key to select ON or OFF.

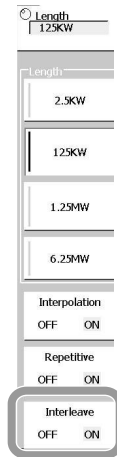

### Explanation

You can turn the interleave mode ON or OFF.

If interleave mode is turned ON, there is a limit to the channels that can be used. In the realtime sampling mode, it is 5 GS/s for 701307/701308/701310/701311(DL9040/DL9040L/DL9140/DL9140L); and 10 GS/s for 701312/701313(DL9240/DL9240L). When set to 5 GS/s for 701310/701311(DL9140/DL9140L); and 10 GS/s for 701312/701313(DL9240/DL9240L), CH2 and CH4 automatically become disabled. For a description of the limitations of the record length, sample rate, and other items when the interleave mode is turned ON, see Appendix 1 Relationship between the Time Axis Setting, Sample Rate and Record Length.



## 7.6 Turning ON/OFF the Interpolation

### Procedure

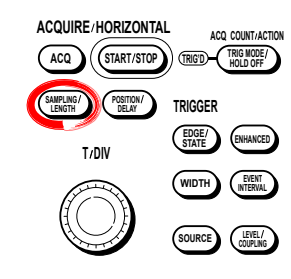

1. Press **SAMPLING/LENGTH**.
2. Press the **Interpolation** soft key to select ON or OFF.

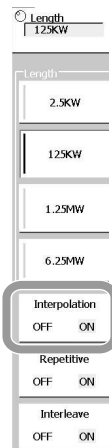

### Explanation

This function interpolates actual sampled data up to 1000 times (or 2000 times when using the high resolution mode) to increase the substantial sampling speed (maximum of 2.5 TS/s).

The following outlines the relationship between interpolation and repetitive sampling when the maximum sample rate is reached.

- When interpolation is ON and repetitive sampling is also ON, interpolation is used if T/div is higher than 50 ns, and the sample rate is less than 500 GS/s. When T/div is less than 50 ns and the sample rate is higher than 500 GS/s, repetitive sampling is used.
- When interpolation is ON, but repetitive sampling is OFF, record length is maintained and interpolated.
- When interpolation is OFF and repetitive sampling is ON, repetitive sampling is performed at a record length less than or equal to 1.25 MW (less than or equal to 625 kW for the DL9040, DL9140, and DL9240).
- If both interpolation and repetitive sampling are OFF, the record length after the maximum sample rate is shortened. Repetitive sampling is performed when the record length is less than 100 W.

## 7.7 Displaying Accumulation

### Procedure

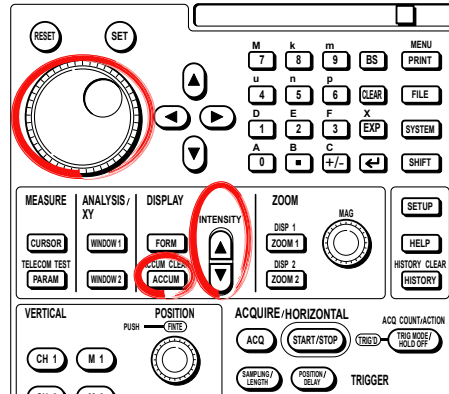

#### Setting the Accumulation Mode

1. Press **ACCUM**.
2. Press the **Accum** soft key to turn the mode ON.
3. Press the **Mode** soft key to select the accumulation mode.

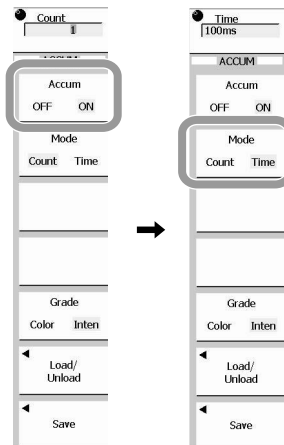

#### Setting the Accumulation Count and Time

4. Use the **rotary knob** to set the count and time.
  - Count: 0 (unlimited)
  - 1 to (number of history waveforms)
  - Time: Infinite
  - 100 ms to 1 s (100 ms intervals)
  - 1 s to 10 s (0.2 s intervals)
  - 10 s to 100 s (2 s intervals)

##### Set to Count Mode

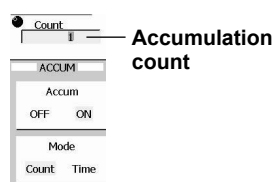

##### Set to Time Mode

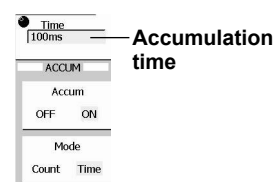

### Setting the Gradation Mode (Grade)

- Press the **Grade** soft key to select the color.  
You can change the brightness of the waveform by using the **INTENSITY** key.

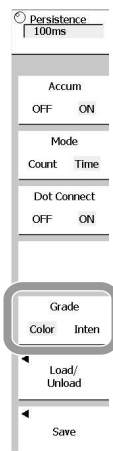

### Saving and Loading an Accumulated Waveform

- Press the **Save** soft key. The save menu appears.
- Press the **Trace** soft key. A menu used to select the waveform to be saved appears.
- Press the soft key corresponding to the waveform to be saved.
- Press the soft key of the internal memory slot to use as the save destination.
- Press the **Load/Unload** soft key. The Load/Unload menu appears.
- To unload the currently loaded accumulated waveform, press the **Unload** soft key.

To load an accumulated waveform, press the soft key of the internal memory slot where the waveform is saved. If an accumulated waveform is already loaded, it is overwritten when the new accumulated waveform is loaded.

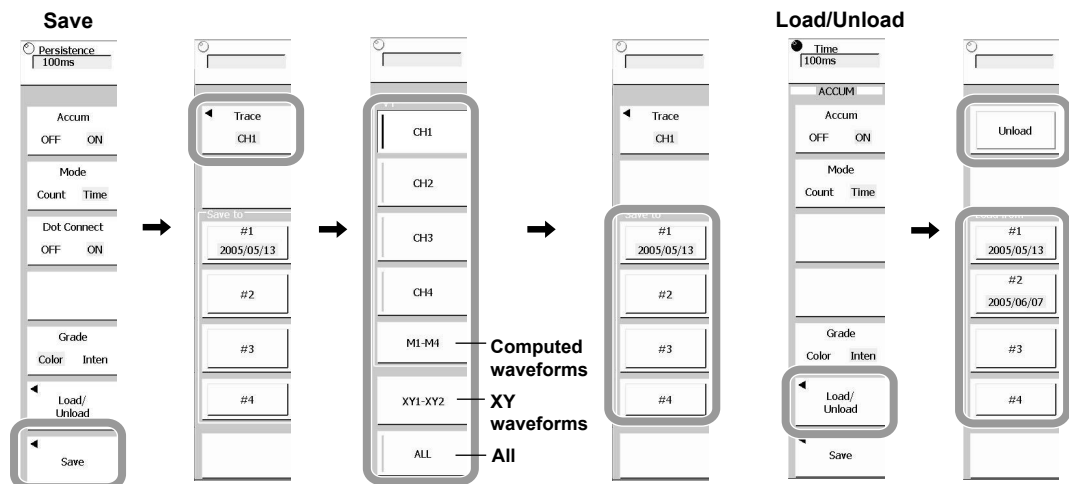

### Explanation

Normally, the display is updated every time a trigger is activated making it difficult to capture transient conditions such as sudden distortion of waveforms. By using the accumulate function, the waveform display of the acquired data remains on the screen for the specified time.

#### **Mode: Mode**

Count: The specified number of the latest waveforms are superimposed.

Time: Waveforms acquired over the specified time are superimposed. The waveforms are displayed with steadily decreasing intensity.

#### **Grade: Grade**

Color: The sequence of colors blue - green - yellow - red - white is used to represent 15 levels of frequency, in ascending order.

Inten: Displays frequency with intensity.

#### **Accumulation Count: Count**

When the mode is Count, the accumulation count is set from 0 to the number of history waveforms. When 0 is selected, waveforms are superimposed indefinitely. The default value is the number of history memory maximum waveforms.

#### **Accumulation Time: Time**

In the Time mode, make the setting Infinite, or in the range 100 ms to 100 s. The default value is 100 ms.

When Infinite is selected, waveforms are superimposed indefinitely.

#### **Precautions for Accumulation**

- Automated measurement of waveform parameters and GO/NO-GO determination are executed on the newest waveform.
- If waveform acquisition is stopped by pressing the START/STOP key, accumulation is temporarily interrupted. All waveforms are cleared and the system starts accumulation starts again from the beginning when accumulation is restarted.
- The following operations occur if the display format is changed while displaying accumulation.
  - During accumulation: The screen is cleared and display starts from the beginning.
  - During accumulation stop time (Time): Waveforms are not cleared.
  - During accumulation stop time (Count): Accumulates the number of history waveforms maintained when in infinite. It may not be the same screen as before. Accumulates the specified number of history waveforms when not in infinite.

#### **Clearing Accumulated Waveforms**

You can clear accumulated waveforms by pressing SHIFT + ACCUM.

#### **Saving and Loading an Accumulated Waveform**

Accumulated waveforms can be saved in four internal memory slots.

Each accumulated waveform that is saved can also be loaded for review. An accumulated waveform that is loaded appears in white.

## 7.8 Setting the Action-on-Trigger

### Procedure

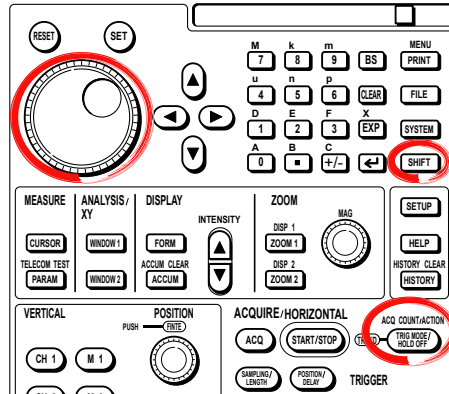

1. Press **SHIFT + TRIG MODE/HOLD OFF**.
2. Press the **Action on TRG** soft key.
3. Press the soft key corresponding to the desired mode.

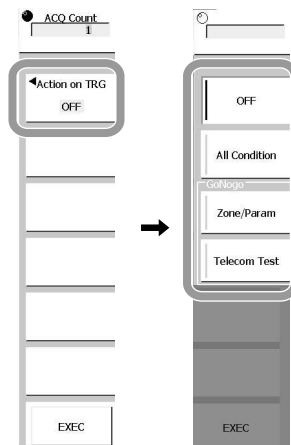

- **OFF:** The specified number of waveforms are acquired. Action-on-trigger is not executed.
- **All Condition:** When the trigger is activated, the waveform is acquired, and the specified action carried out. After the specified number of waveforms have been acquired, the process stops.
- **Zone/Param:** See sections 7.10 to 7.15
- **Telecom Test:** See section 7.16

## 7.8 Setting the Action-on-Trigger

### Action When Trigger Activated

4. Press the **Action** soft key.
5. Press the soft key that corresponds to the desired item and select ON or OFF. If you set Mail-Mode to ON, turn the rotary knob to set the interval.
6. Press ESC. This returns to the Action on Trigger setting screen.

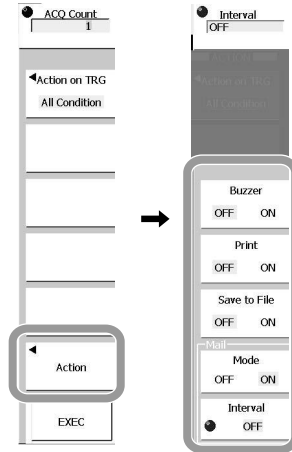

### Setting the Waveform Acquisition Count

7. Turn the **rotary knob** to set the waveform acquisition count. You can use the arrow keys to move the digits to be set.

### Executing the Action-on-Trigger

8. Press the **EXEC** soft key to start acquiring waveforms and execute the action-on-trigger. The EXEC display changes to Abort.

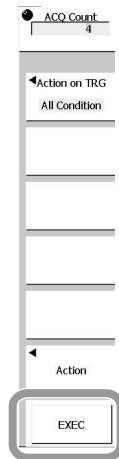

### Stopping the Action-on-Trigger

9. Either press the **Abort** soft key or **START/STOP** to stop acquiring waveforms and to stop the action-on-trigger.

**Explanation****Selecting the Mode**

Select the timing of executing the Action below next subheading.

- **OFF**  
Performs the acquisition for the specified number of times. Acquisition stops at the number of times specified by ACQ Count. The trigger mode this is activated is Normal.
- **All Condition**  
Press EXEC to execute the action when the trigger conditions are established. Stops when the acquisition of the ACQ Count is reached. The trigger mode operates under Normal mode. (This is independent from the "TRIG MODE" in TRIG MODE/HOLD OFF.)
- **Zone/Parameter (GoNogo)**  
Performs GO/NO-GO determination using zone or parameters. Press EXEC to execute the action each time the ZONE/PARAMETER determination conditions are established. Four conditions can be set by mixing zone and parameters. Furthermore, it is also possible to set a logic (AND/OR) for each condition. Stops either when the acquisition of the ACQ Count is reached or when the condition is established for Nogo Count. The trigger mode operates under Normal mode.
- **Telecom Test (GoNogo)**  
Performs GO/NO-GO determination using a Telecom Test. The action is executed each time the determination condition of the Telecom Test is met. Because a Telecom Test measures accumulated waveforms like a Mask Test, it is not performed at the same time as ZONE/PARAMETER.

**Action to Be Performed When the Trigger Condition Is Met**

The specified action (of those below) is performed whenever a trigger is activated.

- **Beep Sound: Buzzer**  
Sounds a warning tone.
- **Print Screen Image: Print**  
Prints the screen image to the destination printer (Printer: built-in printer; USB: USB printer) specified by "Copy to" in the PRINT menu, and saves the screen image data on the specified storage media.
- **Save Waveform Data: Save to File**  
The waveform data is saved to the destination (PC card, USB storage) specified in the FILE menu in binary, ASCII or floating-point format. The format used for saving is linked to the data type (see section 13.5) of the FILE menu.
- **Mail transmission: Mail-Mode/Interval**  
Sends a mail message to a specified address (when Ethernet interface option is installed).  
For the procedure to set the address, "Setting the Mail Transmission" in chapter 15.

**Note**

If you select mail transmission for the action to be taken when a trigger is activated, it is recommended that you place a limitation on the number mails to be sent to prevent overloading the mail server. You can set the upper limit of the number of mail transmissions using ACQ Count or Nogo Count (selectable only when using GoNogo determination).

## 7.8 Setting the Action-on-Trigger

### Number of Actions: ACQ Count

1 to 1000000: Repeats the action the specified number of counts.

Infinite: Repeats the action until waveform acquisition is stopped.

### Operation When Action Is Set to Print or Save to File

The DL9000 operates according to the settings in the Print or FILE menu. For the setup procedure, see chapter 12, "Printing Screen Image", section 13.5, "Saving/Loading the Measurement Data," or section 13.8, "Saving Screen Image Data." If the auto naming function of the File menu is OFF, the file is saved using Numbering. Otherwise, the file is saved using the specified method.

### Trigger mode

The trigger mode is Normal.

This is independent of the trigger mode described in Chapter 6.

### GO/NO-GO determination

For details on GO/NO-GO determination (see sections 7.10 to 7.16).

### Mail Transmission Action

#### Turning Mail Transmission ON/OFF (Mode)

When the Mode is turned ON, mails are transmitted to the address specified by Network > E-Mail Setup > Address (To Address/From Address) in the SYSTEM menu.

### Interval

The mail is sent on the first occurrence of the trigger after the specified interval elapses.

A mail is also sent when action-on-trigger (determination) is finished (or aborted).

The following mail transmission intervals are available. If you select OFF, a mail is sent each time a trigger is activated.

OFF to 1440 min (1 min steps)

#### • Mail Transmission Example When Interval Is Specified

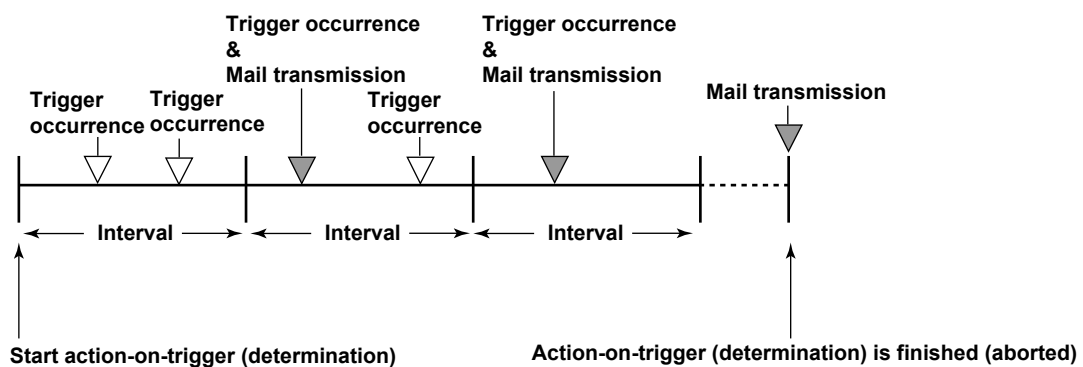



### Contents of the Transmitted Mail

The contents that are sent vary depending on the selected action and the criteria. For the contents that are sent when the action is set to Nogo, see page 7-20.

#### • When Action Is Set to All Condition

<Subject> The subject of the mail. It is shown as a subject or title depending on the mail client. The contents of the subject are shown below. The number inside the parentheses is the Nogo count.  
All Condition Triggered Report (No.) or All Condition Interval Report (No.)

[Comment] Comment

[Trigger Date and Time] Trigger time

[ACQ Count] Number of acquisitions

#### Transmission Example

<Subject> All Condition Interval Report 2  
-----Body of the message from here

[Comment] Sample-All Condition

[Trigger Date and Time] 2006/03/01 16:47:04

[ACQ Count] 1367

### Note

#### Precautions to Be Taken When Setting Action on Trigger

- Settings cannot be changed while action-on-trigger is in progress.
- Averaging uses exponential averaging.
- GO/NO-GO determination is applied for each history waveform when repetitive sampling mode is turned ON.

#### Note When Action Is Set to Save to File

- Do not specify the root directory of the medium as the save destination directory. (Only up to 512 files can be saved to the root directory of a storage medium that has been formatted using the DL9000.)
- If you selected Numbering for the file name assignment method (Auto Name) in the FILE menu, the creation of files takes time when the number of saved files becomes large. In addition, the number of files that are saved when the auto naming function is set to Numbering is up to 1000. To create more than 1000 files, set the auto naming function to Date.
- If a file with the same name exists in the same directory (save destination) when saving data files using the auto naming function, the GO/NO-GO determination stops at that point. To prevent this from happening, prepare a new folder with no files in it or remove all files in the destination folder before starting the GO/NO-GO determination.
- The number of directories and files that can be displayed in the file list is 2500. If the number of directories and files in a directory exceeds 2500, the file list randomly displays 2500 of the directories and files.

## 7.9 Using a GO/NO-GO Determination to Apply an Action-on-Trigger

### Procedure

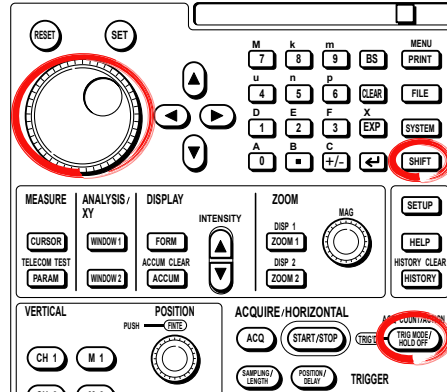

1. Press **SHIFT + TRIG MODE/HOLD OFF**.
2. Press the **Action on TRG** soft key. A menu for the action-on-trigger mode settings appears.
3. Press the **Zone/Param** or **Telecom Test** soft key.

### Selecting the Logic for Determination

4. Press the **Logic** soft key to select either AND or OR.

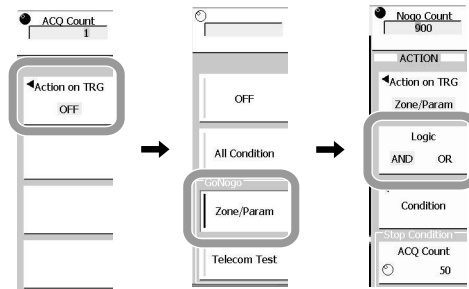

You can make a maximum of four settings for the determination conditions. The GO/NO-GO determination is based on whether all of these determination conditions hold (AND), or whether any one of them holds (OR).

**Setting the Determination Count**

5. Press the **ACQ Count** soft key.
6. Turn the **rotary knob** to set ACQ Count (determination count).
7. Press the **Nogo Count** soft key.
8. Turn the **rotary knob** to set the Nogo Count.

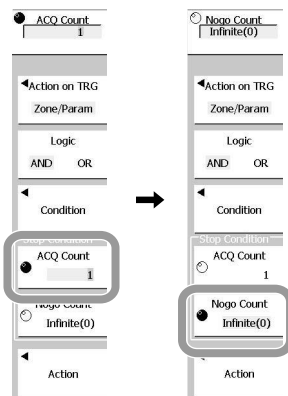

**Selecting the Action After Determination**

9. Press the **Action** soft key.
10. Press the **Buzzer**, **Print**, and **Save** soft keys to turn them ON or OFF.
11. Press **ESC**.

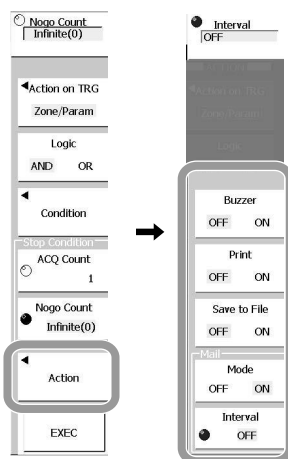

**Executing Determination**

12. Press the **EXEC** soft key. This executes determination. It switches to the Abort soft key. When determination is completed, waveform acquisition automatically stops.

To abort determination, press the Abort soft key or START/STOP.

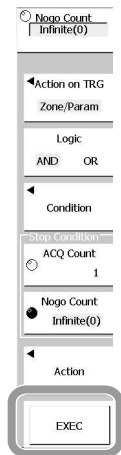

**Stopping or Aborting the Determination**

13. Waveform acquisition stops automatically, when determination is finished, To abort the GO/NO-GO determination, press the **Abort** soft key or **START/STOP**.

**Explanation**

When the specified GO/NO-GO determination conditions are met, the action-on-trigger is applied. For details of the determination condition settings, see sections 7.10 to 7.16.

**Selecting the Mode: Action on TRG**

Select from the following.

- **Zone/Param**  
If Zone/Param is selected, you must set additional determination conditions for each determination mode below. See sections 7.10 to 7.15.
  - Wave: GO/NO-GO determination based on a waveform zone. For the method of setting, see section 7.10.
  - Rect: GO/NO-GO determination based on a rectangular zone. For the method of setting, see section 7.11.
  - Polygon: GO/NO-GO determination based on a polygonal waveform zone. For the method of setting, see section 7.12.
  - Parameter: GO/NO-GO determination based on waveform parameter, XY waveform parameters, and FFT parameters. For the method of setting waveform parameters, see section 7.13, for setting XY waveform parameters see section 7.14, and for FFT parameters see section 7.15.
- **Telecom Test:**  
GO/NO-GO determination based on telecom test result. For the method of setting, see section 7.16.

**Setting the Determination Logic: Logic**

You can make a maximum of four settings for the GO/NO-GO determination conditions. Each of these can have any of the above modes selected. Set the logical operator used to combine this maximum of four determination conditions.

- AND: NO-GO determination when all of determination conditions 1 to 4 hold
- OR: NO-GO determination when any one of determination conditions 1 to 4 holds

**Setting the Determination Count: ACQ Count/Nogo Count**

When the specified count for ACQ Count or Nogo Count is reached, waveform acquisition stops.

**ACQ Count**

Set the number of waveform acquisitions.

- 1 to 1000000: The specified number of waveforms are acquired then the process stops.
- Infinite (0): Waveform acquisition continues until stopped by the Abort soft key or START/STOP.

**Nogo Count**

When the specified number of NO-GO acquisitions has been reached, waveform acquisition is stopped.

- 1 to 1000: Process stops after the specified number of NO-GO determinations.
- Infinite (0): Waveform acquisition continues until stopped by the Abort soft key or START/STOP.

**Action After Determination: Action**

There are four actions that can occur when the condition is met.

**Beep Sound: Buzzer**

Sounds a warning tone.

**Print Screen Image: Print**

Prints the screen image to the destination printer (Printer: built-in printer; USB: USB printer) specified by "Copy to" in the PRINT menu, and saves the screen image data on the specified storage media.

**Save Waveform Data: Save to File**

The waveform data is saved to the destination (PC card, USB storage) specified in the FILE menu in binary, ASCII or floating-point format. The format used for saving is linked to the data type (see section 13.9) of the FILE menu.

**Mail transmission: Mail-Mode/Interval**

Sends a mail message to a specified address (when Ethernet interface option is installed).

For the procedure to set the address, "Setting the Mail Transmission" in chapter 15.

**Operation When Action Is Set to Print or Save to File**

The DL9000 operates according to the settings in the Print or FILE menu. For the setup procedure, see chapter 12, "Printing Screen Image", section 13.5, "Saving/Loading the Measurement Data," or section 13.8, "Saving Screen Image Data." If the auto naming function of the File menu is OFF, the file is saved using Numbering. Otherwise, the file is saved using the specified method.

## 7.9 Using a GO/NO-GO Determination to Apply an Action-on-Trigger

### Mail Transmission Action

#### Turning Mail Transmission ON/OFF (Mode)

When the Mode is turned ON, mails are transmitted to the address specified by Network > E-Mail Setup > Address (To Address/From Address) in the SYSTEM menu.

#### Interval

The mail is sent on the first occurrence of the trigger after the specified interval elapses. A mail is also sent when action-on-trigger (determination) is finished (or aborted). The following mail transmission intervals are available. If you select OFF, a mail is sent each time a trigger is activated.

OFF to 1440 min (1 min steps)

#### • Mail Transmission Example When Interval Is Specified

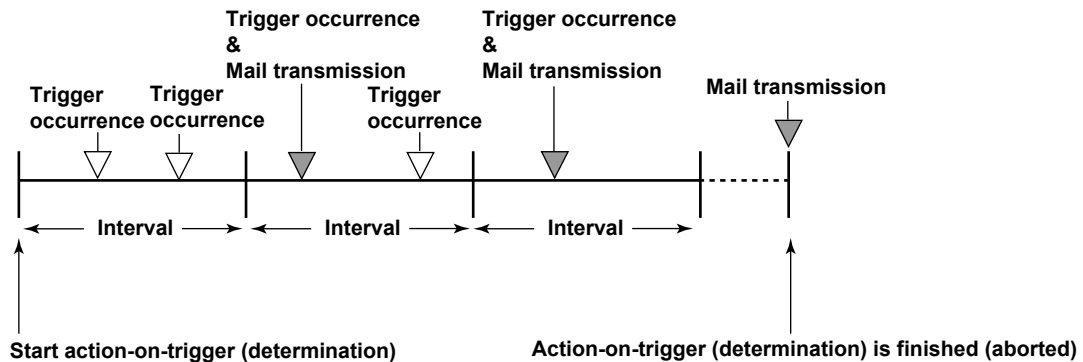

### Contents of the Transmitted Mail

#### When Action Is Set to Nogo (Interval = OFF)

<Subject>	The subject of the mail. The contents of the subject are shown below. The number inside the parentheses is the Nogo count. GoNogo Triggered Report (No.)
[Comment]	Comment
[Setup Information] limits)	Contents of select 1 to 4 (criteria) (parameter and upper/lower limits)  Logic (AND/OR) Stop Nogo/ACQ Count (number of Nogo determinations/ number of waveform acquisitions)
[Trigger Date and Time]	Trigger time
[Nogo/Exec Count]	Nogo count/determination execution count
[Nogo Factor]	Details and measured value of the criteria that resulted in Nogo*

\* Measured value sent only when performing GO/NO-GO determination of waveform parameters

**When Action Is Set to Nogo (Interval Is Not OFF)**

<Subject>	The subject of the mail. The contents of the subject are shown below. The number inside the parentheses is the Nogo count. GoNogo Interval Report (No.)
[Comment]	Comment
[Setup Information]	Contents of select 1 to 4 (criteria) Logic (AND/OR) Stop Nogo/ACQ Count (number of Nogo determinations/ number of waveform acquisitions)
[TimeRange]	Time from start to now
[Nogo/ExecCount]	Nogo count/determination execution count
[EachNogoCount]	Nogo count of each criteria up to now (when the logic is OR) Not included when the logic is AND.

**Transmission Example**

```

Subject      GoNogo Triggered Report 23
-----Body of the message from here
[Comment]   Sample-GoNogo
[Setup Information] Select1:Rect(C1,Main) (Left:-3.0000E+00,Right:-2.5000E+00,Upper: 500.00E-03,Lower:-500.00E-03,Condition:In)
                Select2:Wave(C2,Z1) (Range1:-5.0000E+00,Range2: 5.0000E+00,Condition:Out)
                Select3:Polygon(C3,Z2) (Condition:In)
                Select4:Measure(Max(C4)) (Upper: 1.0000E+00,Lower:-1.0000E+00,Condition:Out)

                Logic:OR
                Stop Nogo/ACQ Count:100/100

[Trigger Date and Time]      2006/03/06 13:53:46

[Nogo/Exec Count]           23/56

[Nogo Factor]               Select1:Rect(C1,Main)
                            Select2:Wave(C2,Z1)
                            Select3:Polygon(C3,Z2)

```

## 7.9 Using a GO/NO-GO Determination to Apply an Action-on-Trigger

---

### **Note**

#### **Precautions for GO/NO-GO Determination**

- The results of the determination (the determination count and fail count) are displayed on the screen.
- All keys other than the START/STOP key and the Abort soft key are disabled while determination is in progress. (When Remote is ON, the Exec (One Shot) soft key is also enabled.)
- When GO/NO-GO determination is executed, the trigger mode is automatically changed to "Normal".

#### **Note When Action Is Set to Save to File**

- Do not specify the root directory of the medium as the save destination directory. (Only up to 512 files can be saved to the root directory of a storage medium that has been formatted using the DL9000.)
- If you selected Numbering for the file name assignment method (Auto Name) in the FILE menu, the creation of files takes time when the number of saved files becomes large. In addition, the number of files that are saved when the auto naming function is set to Numbering is up to 1000. To create more than 1000 files, set the auto naming function to Date.
- If a file with the same name exists in the same directory (save destination) when saving data files using the auto naming function, the GO/NO-GO determination stops at that point. To prevent this from happening, prepare a new folder with no files in it or remove all files in the destination folder before starting the GO/NO-GO determination.
- The number of directories and files that can be displayed in the file list is 2500. If the number of directories and files in a directory exceeds 2500, the file list randomly displays 2500 of the directories and files.

#### **Note When Action Is Set to Mail-Mode Interval**

- It is recommended that you place a limitation on the number mails to be sent to prevent overloading the mail server. You can set the upper limit of the number of mail transmissions using ACQ Count or Nogo Count (selectable only when using GoNogo determination).
  - The screen image can be attached only when the interval is set to OFF.
-



## 7.10 Setting the Waveform Zone GO/NO-GO Determination Conditions

### Procedure

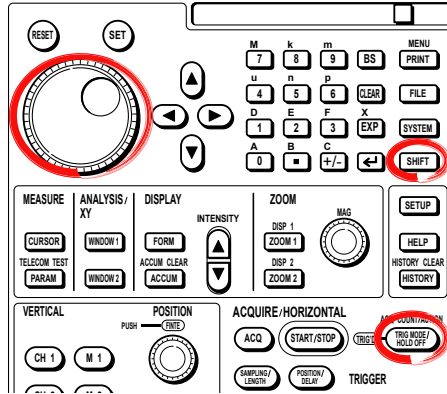

#### Setting the GO/NO-GO Determination Mode

1. Press **SHIFT + TRIG MODE/HOLD OFF**.
2. Press the **Action** on TRG soft key.
3. Press the **Zone/Param** soft key.
4. Press the **Condition** soft key. The Condition setting menu appears.

#### Setting the Determination Condition Number

5. Press the **Select** soft key.
6. Select the determination condition number. Press the soft key corresponding to the number.

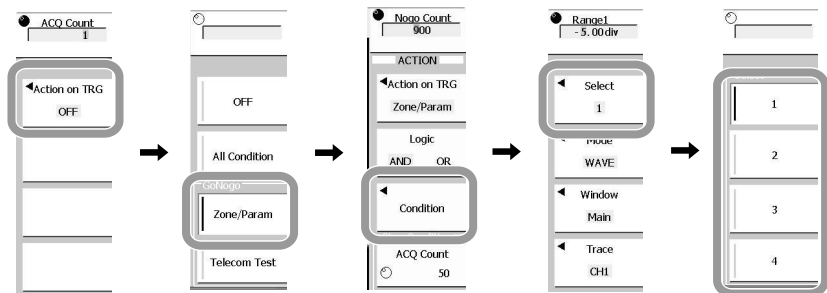

#### Setting the Determination Mode

7. Press the **Mode** soft key. The Mode setting menu appears.
8. Press the **WAVE** soft key. The waveform zone setting menu appears.

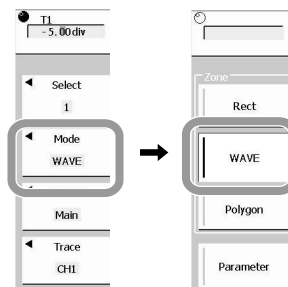

## 7.10 Setting the Waveform Zone GO/NO-GO Determination Conditions

### Selecting the Window for the Determination

9. Press the **Window** soft key. The menu for setting the Window for the determination appears.
10. Select the Window for the determination from Main, Zoom1, and Zoom2.

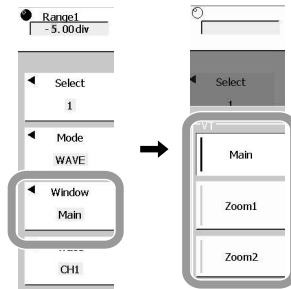

### Selecting the Waveform Targeted for Determination

11. Press the **Trace** soft key.
12. Select a channel. Press the soft key corresponding to CH1 to CH4. To select M1 to M4, press the **M1-M4** soft key. Select one after it is switched.

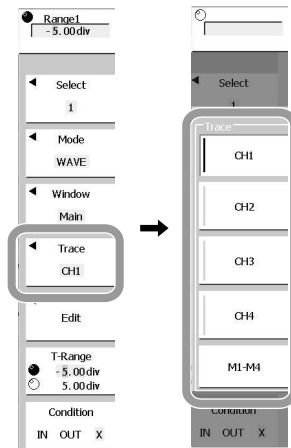

**Creating a New Determination Zone**

13. Press the **Edit** soft key.
14. Press the **New REF Trace** soft key.
15. Specify the trace to be used as the zone base. Press the soft key corresponding to the desired channel to be traced. To trace M1 to M4, press the **M1-M4** soft key. After it is switched, press the corresponding soft key again.
16. Press the **Whole/Part** soft key to specify the range to edit. To edit the entire zone, select Whole; To edit a portion of the zone, select Part.

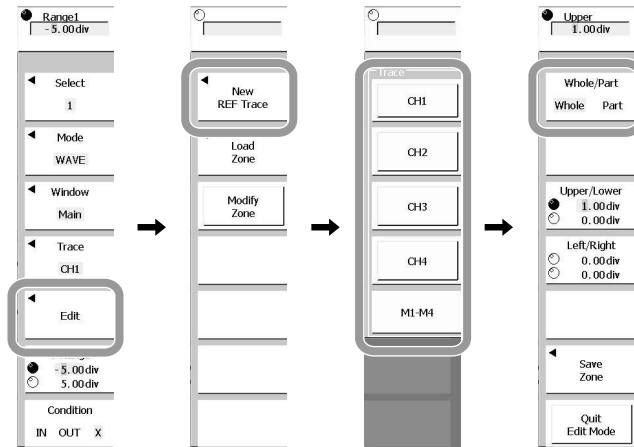

• **Editing the Whole Zone**

17. Press the **Upper/Lower** or **Left/Right** soft key to select direction to set the zone.
18. Use the **rotary knob** to create a zone.
19. Repeat steps 17 to 18 to edit the zone.
20. To save the zone, press the **Save Zone** soft key. This will open a menu for setting the location to register the zone you edited.
21. Specify the destination for the zone to be registered. Press the soft key corresponding to #1 to #4.
22. Press the **Quit Edit Mode** soft key to confirm the registration.  
To edit part of the zone, proceed to step 23. To quit creating zones, proceed to step 39.

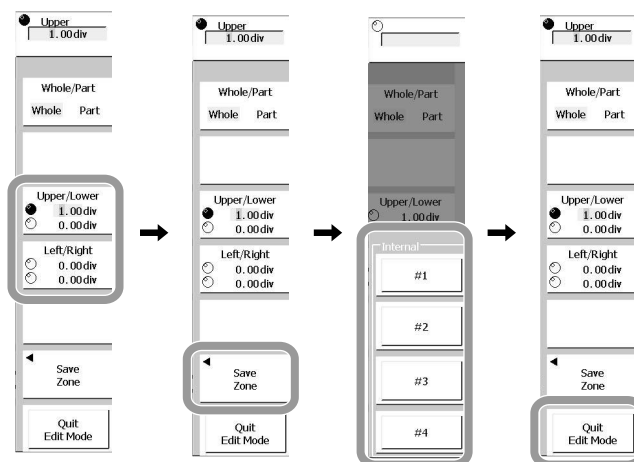

## 7.10 Setting the Waveform Zone GO/NO-GO Determination Conditions

- **Editing Part of the Zone**

23. Press the **Whole/Part** soft key, then select Part.
24. Press the **Edit Range** soft key to select the left or the right cursor.
25. Use the **rotary knob** to set the right and left edges of the part of the zone.  
Similarly, set the left or right edge settings that have not yet been set, to specify the range to create the zone.
26. Press the **Upper/Lower** soft key to select the direction to set the zone.
27. Use the **rotary knob** to create a zone.
28. Repeat steps 24 to 27 to edit the zone.
29. To save the zone, press the **Save Zone** soft key. This will open a menu for setting the location to register the zone you edited.  
Specify the destination for the zone to be registered. Press the soft key corresponding to #1 to #4.
30. Press the **Quit Edit Mode** soft key to confirm the registration.

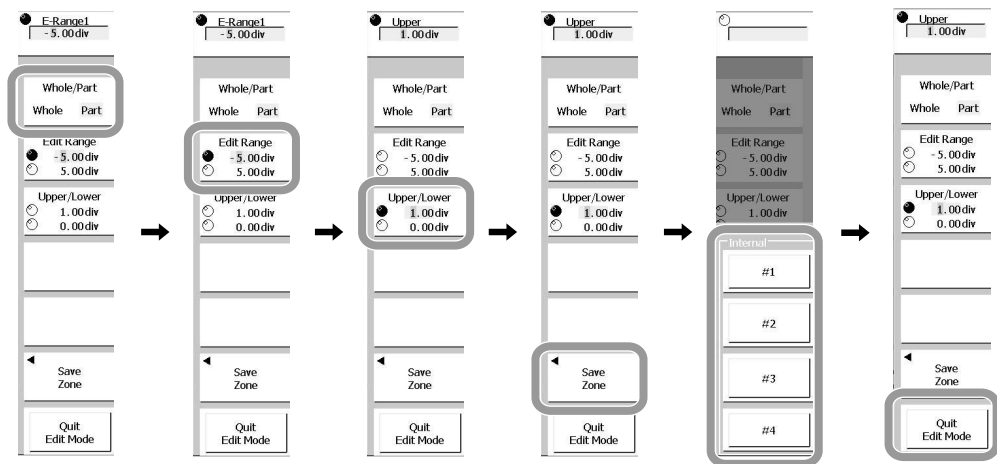

- **Modifying a Zone**

31. To edit a previously registered zone, press the **Load Zone** soft key. To edit the currently used zone, skip to step 33.
32. Specify the registration location of the determination zone to modify. Press the soft key corresponding to #1 to #4. The determination zone saved before is loaded.
33. Press the **Modify Zone** soft key.
34. Modify the waveform according to the steps 17 to 30.
35. When you finish the modifications, press the **Quit Edit Mode** soft key.

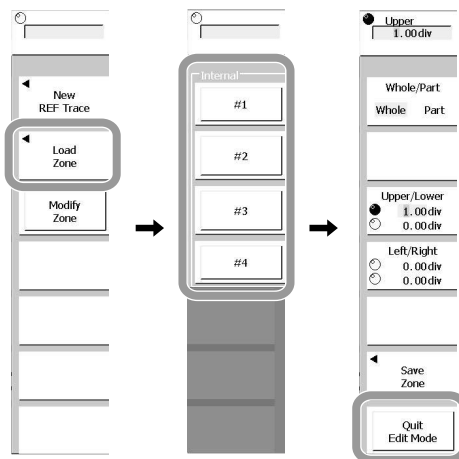

**Setting the Determination Interval**

36. Press the **Time Range** soft key.
37. Use the **rotary knob** to set the determination interval.

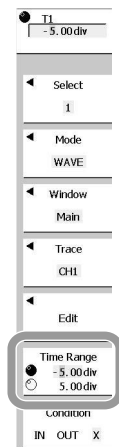
**Selecting the Reference for Determination**

38. Press the **Condition** soft key to select from IN, OUT or X.
39. Press **ESC** to return to the GO/NO-GO menu.

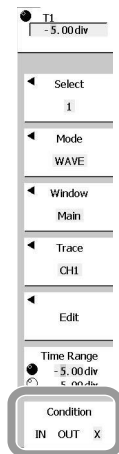

If necessary, repeat the steps above for the determination condition numbers 1 to 4.

### Explanation

This section explains creating a zone based on a reference waveform and performing GO/NO-GO determination on whether the waveform exits or enters that zone.

#### **Selecting the Basic Waveform: Edit**

Select the basic waveform to create a determination zone. Select the basic waveform from CH1 to CH4 and M1 to M4 that is displayed as a trace. You cannot select traces that are not displayed.

#### **Creating a Determination Zone: New REF Trace**

Up to four determination zones can be set. The following shows the setting range.

- Setting range in the up and down directions:  $\pm 8$  divisions from the basic waveform
  - Setting range in the left and right directions:  $\pm 5$  divisions from the screen center
- Targeted waveforms that are determined using the determination zone registered in determination condition numbers 1 to 4, can be selected from the input signal waveforms (CH1 to CH4) and operation waveforms (M1 to M4). Zones that are enabled by the condition settings are displayed on the screen.

#### **Setting the Determination Conditions: Condition**

- **Selecting the Target Waveform: Trace**  
Select from the CH1 to CH4 and M1 to M4 waveforms.
- **Setting the Determination Conditions: Select**  
Select the determination condition number for setting the determination condition. Each of the four determination conditions can be set.
- **Setting the Determination Interval: Time Range**  
In the initial settings, the  $\pm 5$  divisions in the frame displayed for the time axis are the determination range. However, this can be limited to any desired range. Consider the determination range to be the same as the setting range for the cursor display position in cursor measurements.
- **Setting the Reference for Determination: Condition**
  - IN: Performs NO-GO when the targeted waveform enters the determination zone.
  - OUT: Performs NO-GO when the targeted waveform exits the determination zone.
  - X: GO/NO-GO determination is not performed.

# 7.11 Setting the Rectangular Zone GO/NO-GO Determination Conditions

## Procedure

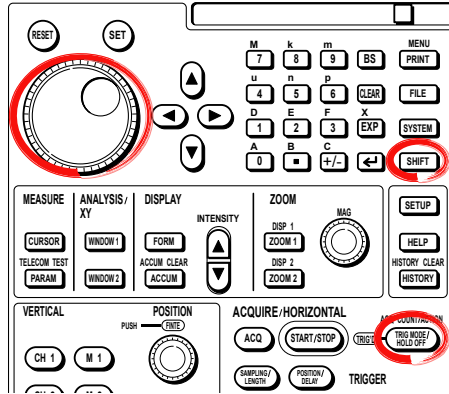

### Setting the GO/NO-GO Determination Mode

1. Press **SHIFT + TRIG MODE/HOLD OFF**.
2. Press the **Action on TRG** soft key.
3. Press the **Zone/Param** soft key.
4. Press the **Condition** soft key.

### Selecting the Determination Condition Number

5. Press the **Select** soft key.
6. Select the determination condition number. Press the soft key corresponding to the number to be set.

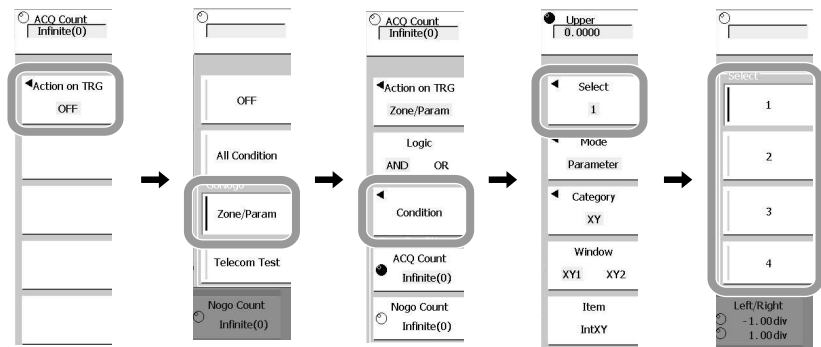

### Setting the Determination Mode

7. Press the **Mode** soft key. The Mode setting menu appears.
8. Press the **RECT** soft key. The rectangular zone setting menu appears.

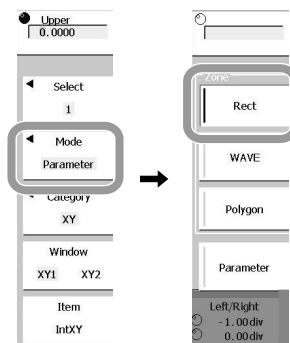

## 7.11 Setting the Rectangular Zone GO/NO-GO Determination Conditions

### Selecting the Reference for Determination

9. Press the **Condition** soft key to select from IN, OUT or X. When you select IN or OUT, the zone appears on the screen.

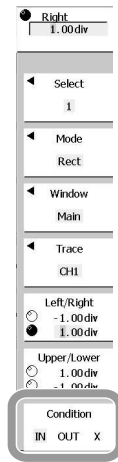

### Setting a Determination Zone

10. Press the **Left/Right** or **Upper/Lower** soft key to select the direction to set the zone.
11. Use the **rotary knob** to create a zone.
12. Repeat steps 10 to 11 to edit the zone.

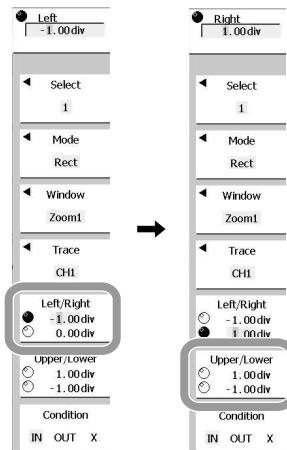



**Setting the Determination Conditions**

• **Selecting the Window Targeted for Determination**

- 13. Press the **Window** soft key.
- 14. Select the window to target for determination. Press the soft key corresponding to the desired window to target for determination.

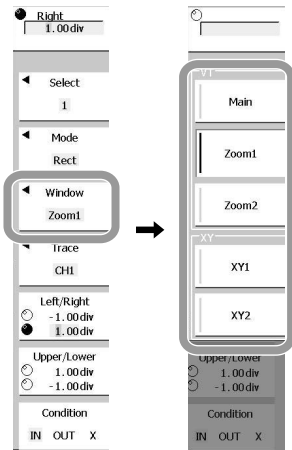

• **Selecting the Target Waveform**

- 15. Press the **Trace** soft key.
- 16. Select a channel. Press the soft key corresponding to CH1 to CH4. To select M1 to M4, press the **M1-M4** soft key. Select one after it is switched.

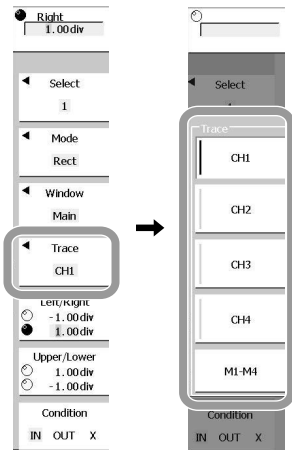

- 17. Press **ESC** to return to the GO/NO-GO menu.

If necessary, repeat the steps above for the determination condition numbers 1 to 4.

### Explanation

Create a rectangular waveform by setting the up/down, and left/right limit values on the screen. GO/NO-GO determination is performed either when the waveform enters into that range or does not enter that range.

#### Setting a Determination Zone: Left/Right, Upper/Lower

Sets the range for determining determination conditions. One determination zone can be set. The setting range is shown below.

- Setting range in the up and down directions: Setting resolution of  $\pm 4$  divisions from the basic waveform: 0.01 div
- Setting range in the left and right directions: Setting resolution of  $\pm 5$  divisions from the screen center: 0.01 div

#### Note

---

The rectangular zone disappears when Condition is set to X, or the display of the relevant waveform is set to OFF.

---

#### Setting the Determination Conditions: Select

Select the determination condition number for setting the determination condition. Each of the four determination conditions can be set.

- **Selecting the Window Targeted for Determination: Window**
  - Main: Targets normal waveforms.
  - Zoom1: Targets zoom box 1 waveforms.
  - Zoom2: Targets zoom box 2 waveforms.
  - XY1: Targets XY window 1 waveforms.
  - XY2: Targets XY window 2 waveforms.
- **Selecting the Target Waveform: Trace**

Select from the CH1 to CH4 and M1 to M4 waveforms.
- **Selecting the Reference for Determination: Condition**
  - IN: Performs NO-GO when the targeted waveform enters the determination zone.
  - OUT: Performs NO-GO when the targeted waveform exits the determination zone.
  - X: GO/NO-GO determination is not performed.

## 7.12 Performing GO/NO-GO Determination Using a Polygon Waveform

### Procedure

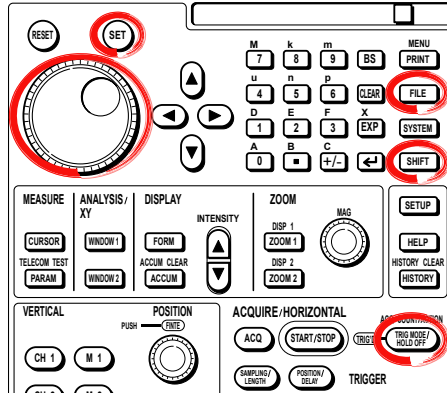

### Loading a Polygon Figure

This section describes simply how to load a polygon. For more details, see section 13.7.

1. Press **FILE**.
2. Select the directory of the PC card or USB memory where the polygon figure file is saved.
3. Press the **Open** soft key.
4. Select the targeted file and press **SET**.
5. Press the **Load** soft key. Displays a menu used to load files.
6. Press the **Type** soft key. Displays a menu used to select polygon figure or mask pattern.
7. Press the **Zone Polygon** soft key.
8. Press the soft key corresponding to the zone number of the destination for loading.
9. Press the **Load EXEC** soft key. The selected file is loaded.

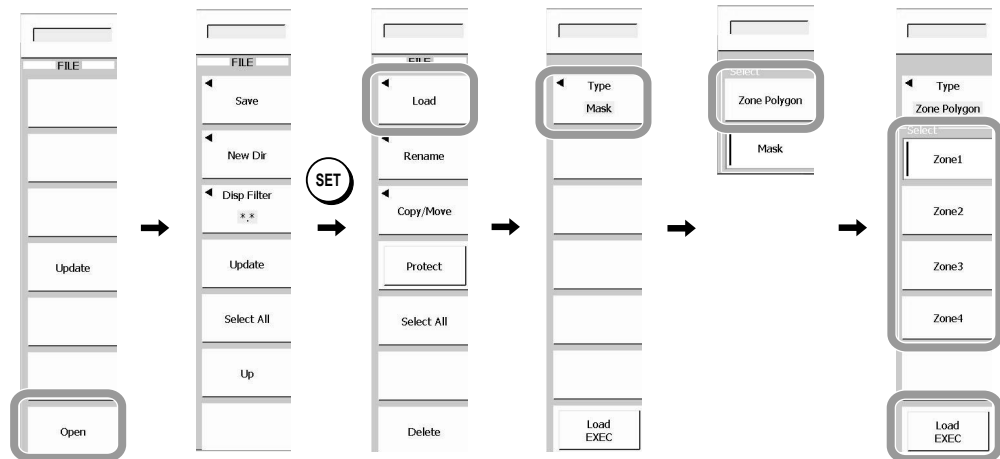

## 7.12 Performing GO/NO-GO Determination Using a Polygon Waveform

### Setting the GO/NO-GO Determination Mode

10. Press **SHIFT + TRIG MODE/HOLD OFF**.
  11. Press the **Action on TRG** soft key.
  12. Press the **Zone/Param** soft key.
  13. Press the **Condition** soft key.
- **Selecting the Determination Condition Number**
    14. Press the **Select** soft key.
    15. Select the determination condition number. Press the soft key corresponding to the number to be set.

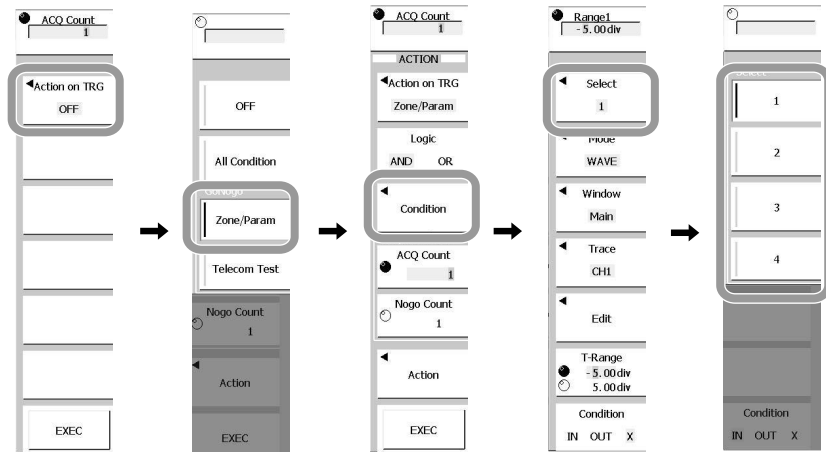

- **Setting the Determination Mode**

16. Press the **Mode** soft key.
17. Press the **Polygon** soft key.

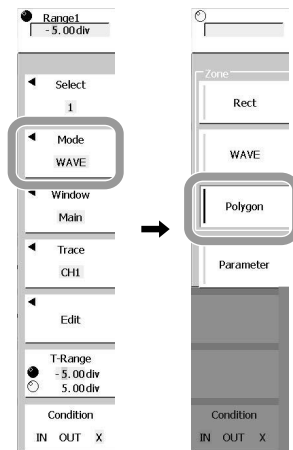

### Setting the Determination Conditions

- **Selecting the Window Targeted for Determination**

18. Press the **Window** soft key.
19. Select the window to target for determination. Press the soft key corresponding to the desired window to target for determination.

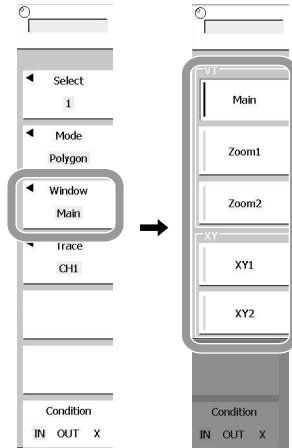

- **Selecting the Target Waveform**

20. Press the **Trace** soft key.
21. Select a channel. Press the soft key corresponding to CH1 to CH4. To select M1 to M4, press the **M1-M4** soft key. Select one after it is switched.

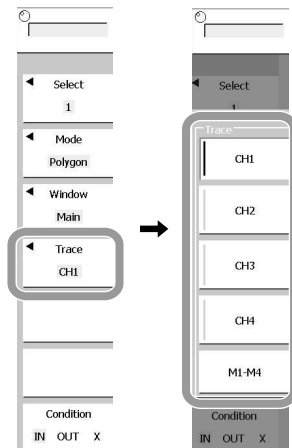

## 7.12 Performing GO/NO-GO Determination Using a Polygon Waveform

- **Selecting the Reference for Determination**
  22. Press the **Condition** soft key to select from IN, OUT or X.
  23. Press **ESC** to return to the GO/NO-GO menu.

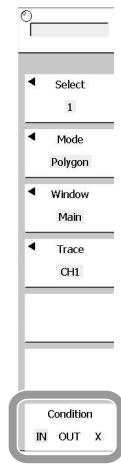

If necessary, repeat the steps above for the determination condition numbers 1 to 4.

### Explanation

Load the polygon figure generated on your PC. GO/NO-GO determination is performed either when the figure enters into that range or does not enter that range.

#### Loading a Polygon Figure

Load a polygon figure in advance. Use a dedicated software application on your PC to generate a polygon figure.

#### Setting the Determination Conditions: Select

Select the condition number for setting the determination condition. Each of the four determination conditions can be set.

- **Selecting the Window Targeted for Determination: Window**
  - Main: Targets normal waveforms.
  - Zoom1: Targets zoom box 1 waveforms.
  - Zoom2: Targets zoom box 2 waveforms.
  - XY1: Targets XY window 1 waveforms.
  - XY2: Targets XY window 2 waveforms.
- **Selecting the Target Waveform: Trace**

Select from the CH1 to CH4 and M1 to M4 waveforms.
- **Selecting the Reference for Determination: Condition**
  - IN: Performs NO-GO when the targeted waveform enters the determination zone.
  - OUT: Performs NO-GO when the targeted waveform does not enter the determination zone.
  - X: GO/NO-GO determination is not performed.

## 7.13 Setting the Waveform Parameter GO/NO-GO Determination Conditions

### Procedure

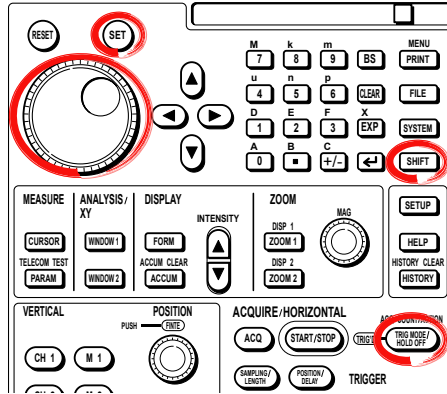

#### Setting the GO/NO-GO Determination Mode

1. Press **SHIFT + TRIG MODE/HOLD OFF**.
2. Press the **Action** on TRG soft key.
3. Press the **Zone/Param** soft key.
4. Press the **Condition** soft key.

#### • Selecting the Determination Condition Number

5. Press the **Select** soft key.
6. Select the determination condition number. Press the soft key corresponding to the number to be set.

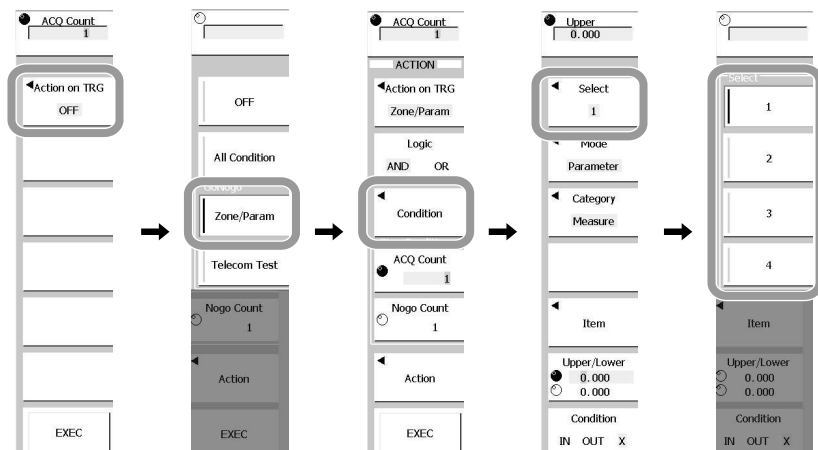

#### • Setting the Determination Mode

7. Press the **Mode** soft key.
8. Press the **Parameter** soft key.

## 7.13 Setting the Waveform Parameter GO/NO-GO Determination Conditions

- **Setting a Category**

9. Press the **Category** soft key.  
Displays a menu used to select a category.
10. Press the **Measure** soft key.

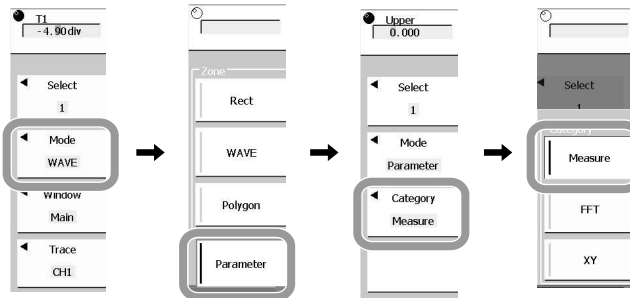

### Selecting the Area Targeted for Determination

11. Press the **Item** soft key.
12. Press the **Area** soft key to select Area 1 or Area 2.  
Another selection menu appears on products with firmware version 3.6 or later. Select Area1 or Area2 on that menu.

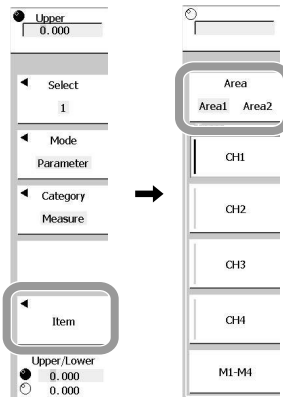

### Selecting the Target Waveform

13. Select a channel. Press the soft key corresponding to CH1 to CH4 or M1 to M4.  
To select M1 to M4, press the **M1-M4** soft key. Select one after it is switched.
14. Turn the **rotary knob** to select an item. Then press SET.

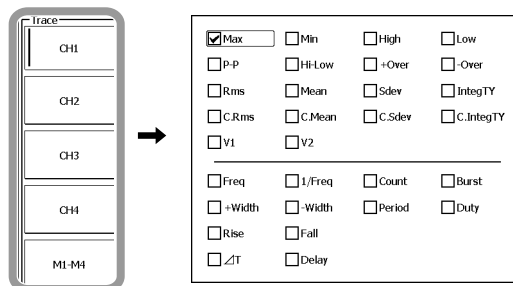



### Selecting a Computation

15. Use **Calc** soft key to select a computation value that uses the waveform parameter value for that item.  
 On products with firmware version 3.6 or later, press the **Calc** soft key in step 12.
16. Turn the **rotary knob** to select an equation. Then press SET. Select an equation from among those set by automatic measurement of waveform parameters.
17. Press **ESC**.

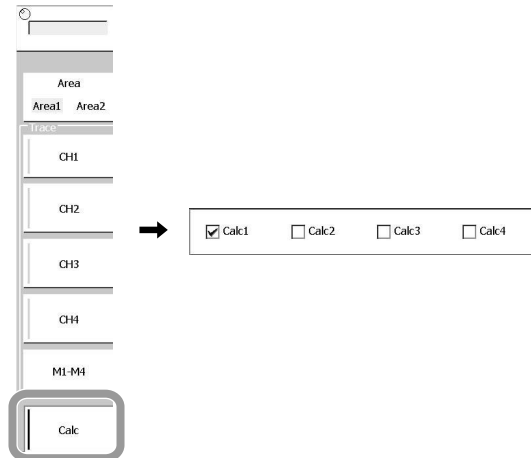

### Setting a Determination Zone

18. Press the **Upper/Lower** soft key to select the item to set a range.
19. Use the **rotary knob** to set the Upper and Lower.

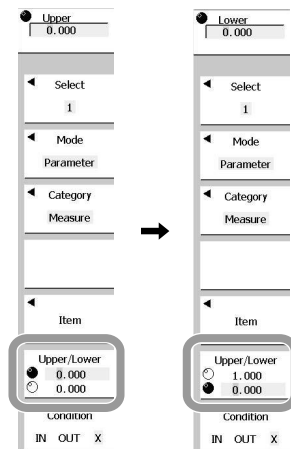

## 7.13 Setting the Waveform Parameter GO/NO-GO Determination Conditions

---

### Selecting the Reference for Determination

20. Press the **Condition** soft key to select from IN, OUT or X.
21. Press **ESC** to return to the GO/NO-GO menu.

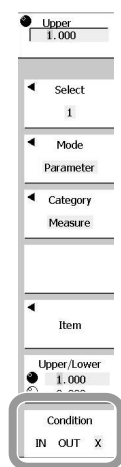

If necessary, repeat the steps above for the determination condition numbers 1 to 4.

### Explanation

GO/NO-GO determination is performed either when the values enter into the specified range or they are outside of that range, using the automatically measured values of the waveform parameter.

### Setting the Determination Conditions: Select

Specify the determination condition number. Each of the four determination conditions can be set.

### Selecting the Area Targeted for Determination: Area

Select from Area 1 and Area 2.

### Selecting the Reference for Determination: Condition

- IN: Performs NO-GO when the value of the waveform parameter targeted for determination is within the upper and lower limit values.
- OUT: Performs NO-GO when the value of the waveform parameter targeted for determination is outside of the upper and lower limit values.
- X: GO/NO-GO determination is not performed.

### Note

When the waveform parameter measurement is set to cycle statistical processing (PARAM > Mode = Cycle Statistics), the "Statistic" item appears in the soft key menu that is displayed in step 4 (when the Condition soft key is pressed). In addition, the Area soft key in step 12 does not appear.

Press the Statistic soft key and select the item on which to perform statistical processing. Max (maximum value), Min (minimum value), Mean,  $\sigma$  (standard deviation)

For a description of the cycle statistical processing, see section 10.3.

---

## 7.14 Setting the FFT Parameter GO/NO-GO Determination Conditions

### Procedure

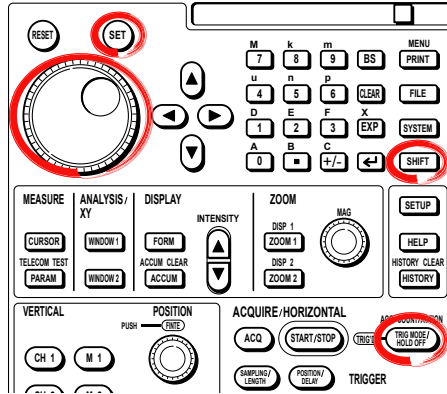

#### Setting the GO/NO-GO Determination Mode

1. Press **SHIFT + TRIG MODE/HOLD OFF**.
  2. Press the **Action** on TRG soft key.
  3. Press the **Zone/Param** soft key.
  4. Press the **Condition** soft key.
- **Selecting the Determination Condition Number**
    5. Press the **Select** soft key.
    6. Select the determination condition number. Press the soft key corresponding to the number to be set.

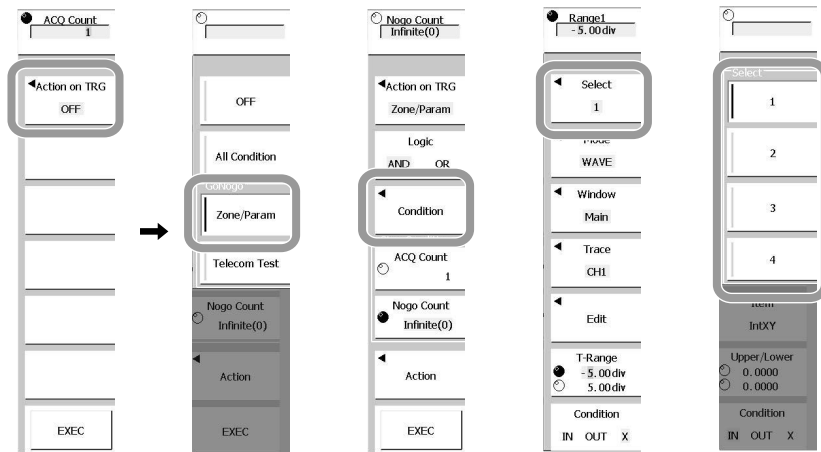

## 7.14 Setting the FFT Parameter GO/NO-GO Determination Conditions

7. Press the **Mode** soft key.
8. Press the **Parameter** soft key.
9. Press the **Category** soft key.
10. Press the **FFT** soft key.

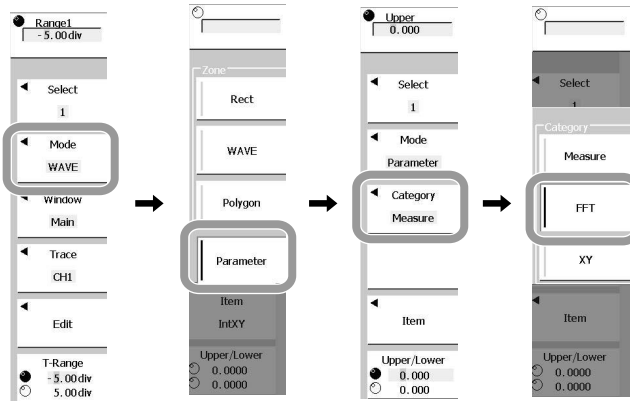

### Setting the Determination Conditions

- **Selecting a Window of a Targeted Item**

11. Press the **Window** soft key to select FFT 1 (result of Window 1 analysis) or FFT 2 (result of Window 2 analysis).

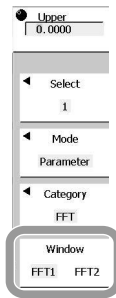

- **Selecting an Item**

12. Press the **Item** soft key.
13. Press the **Basic** soft key.
14. Select an item from the dialog box that is displayed. Use the **rotary knob** to select the item. Then, press SET to apply a check mark.

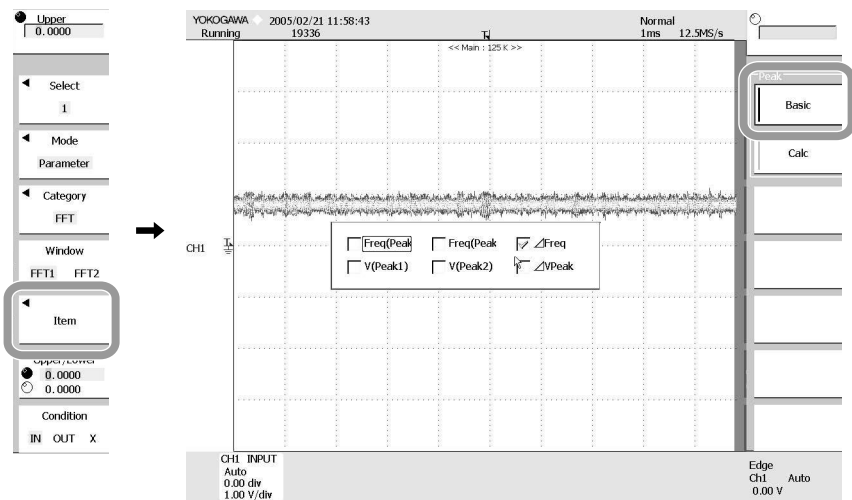

• **Setting a Computation**

15. Use Calc soft key to select a computation value that uses an FFT value for that item.
16. Select the Calc to use to apply a check mark.  
Turn the **rotary knob** to select the item. Then, press SET to apply a check mark. Select an equation from among those set by FFT analysis.
17. Press **ESC**.

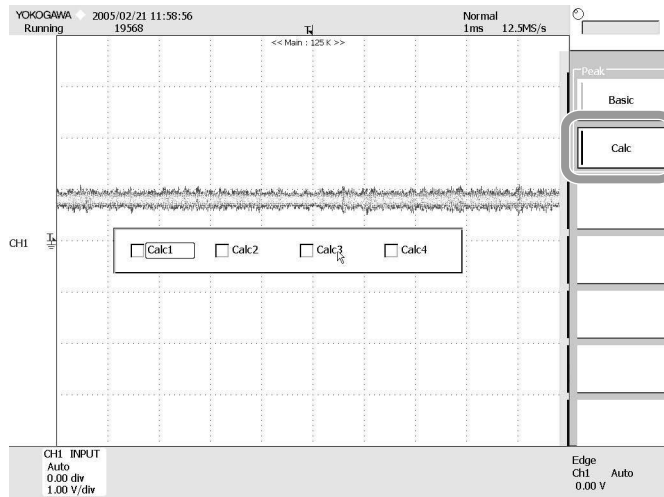

• **Setting the Determination Range**

18. Press the **Upper/Lower** soft key to select the item to set a range.
19. Use the **rotary knob** to set either the Upper or the Lower.

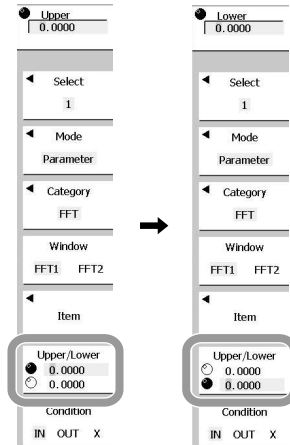

## 7.14 Setting the FFT Parameter GO/NO-GO Determination Conditions

- **Selecting the Reference for Determination**
  20. Press the **Condition** soft key to select from IN, OUT or X.
  21. Press **ESC** to return to the GO/NO-GO menu.

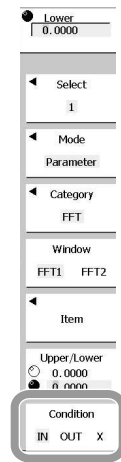

If necessary, repeat the steps above for the determination condition numbers 1 to 4.

### Explanation

GO/NO-GO determination is performed either when the values enter into the specified range or they do not enter that range using the item of the measurements of FFT, or the results of the computation that used that item.

### Determination Conditions: Condition

- **Setting the Determination Conditions: Select**

Select the determination condition number for setting the determination condition. Each of the four determination conditions can be set.
- **Selecting the Window Targeted for Determination: Window**

Use the marker loaded values of the selected FFT window. See section 11.6 for details on setting using FFT.
- **Selecting a Item: Item**

Select the item to use in determination from the measured items of the window selected using the window to target for determination.

  - Basic: Select one from the six types.
  - Calc: Select when using a computation that uses the computed values of FFT. Select from Calc 1 to Calc 4. See section 10.9 for details on setting each item.
- **Setting the Determination Range: Upper/Lower**

Sets the upper and lower limit values for the values of the specified determination item.
- **Selecting the Reference for Determination: Condition**
  - IN: Performs NO-GO when the value of the item targeted for determination is within the upper and lower limit values.
  - OUT: Performs NO-GO when the value of the item targeted for determination is outside of the upper and lower limit values.
  - X: GO/NO-GO determination is not performed.

## 7.15 Setting the XY Waveform Parameter GO/NO-GO Determination Conditions

### Procedure

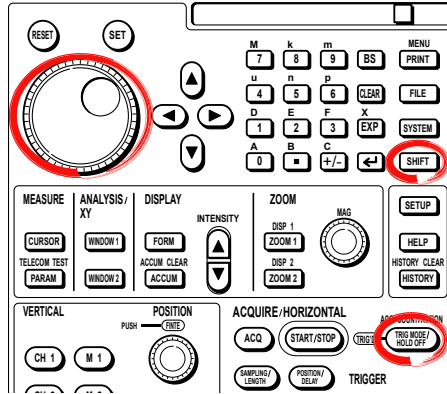

#### Setting the GO/NO-GO Determination Mode

1. Press **SHIFT + TRIG MODE/HOLD OFF**.
  2. Press the **Action** on TRG soft key.
  3. Press the **Zone/Param** soft key.
  4. Press the **Condition** soft key.
- **Selecting the Determination Condition Number**
    5. Press the **Select** soft key.
    6. Select the determination condition number. Press the soft key corresponding to the number to be set.

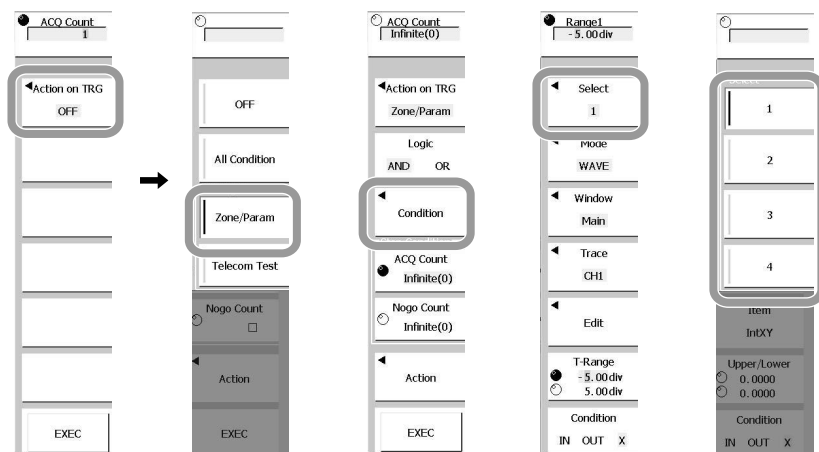

## 7.15 Setting the XY Waveform Parameter GO/NO-GO Determination Conditions

- **Setting the Determination Mode**
  7. Press the **Mode** soft key.
  8. Press the **Parameter** soft key.
  9. Press the **Category** soft key.
  10. Press the **XY** soft key.

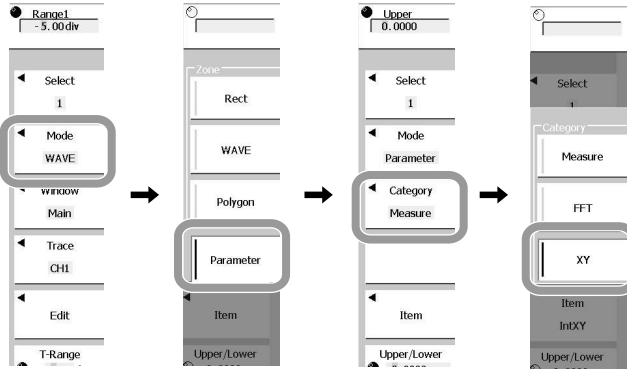

### Setting the Determination Conditions

- **Selecting the Window Targeted for Determination**
  11. Press the **Window** soft key to select XY1 (XY of Window 1) or XY2 (XY of Window 2).

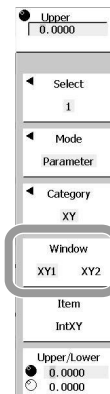

- **Setting the Determination Range**
  12. Press the **Upper/Lower** soft key to select the item to set a range.
  13. Use the **rotary knob** to set either the Upper or the Lower.

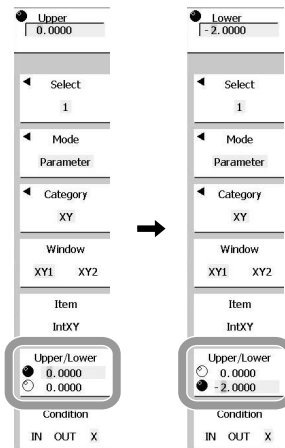



- **Selecting the Reference for Determination**
  14. Press the **Condition** soft key to select from IN, OUT or X.
  15. Press **ESC** to return to the GO/NO-GO menu.

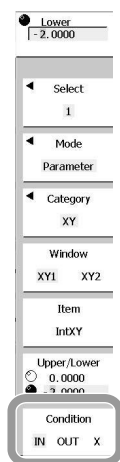

If necessary, repeat the steps above for the determination condition numbers 1 to 4.

### Explanation

Perform GO/NO-GO determination is performed either when the values enter into the specified range or they are outside of that range using the measured XY waveform value.

### Determination Conditions: Condition

- **Setting the Determination Conditions: Select**  
Select the determination condition number for setting the determination condition. Each of the four determination conditions can be set.
- **Selecting the Window Targeted for Determination: Window**
  - XY1: Targets XY window 1 waveforms.
  - XY2: Targets XY window 2 waveforms.
- **Setting the Determination Range: Upper/Lower**  
Sets the upper and lower limit values for the values of the specified determination item.
- **Selecting the Reference for Determination: Condition**
  - IN: Performs NO-GO when the value of the item targeted for determination is within the upper and lower limit values.
  - OUT: Performs NO-GO when the value of the item targeted for determination is outside of the upper and lower limit values.
  - X: GO/NO-GO determination is not performed.

## 7.16 Setting the Telecom Test GO/NO-GO Determination Conditions

### Procedure

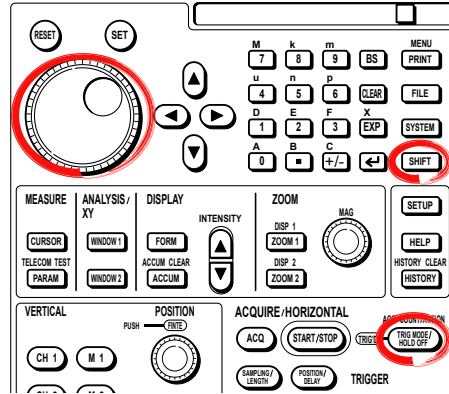

#### Setting the GO/NO-GO Determination Mode

1. Press **SHIFT + TRIG MODE /HOLD OFF**.
  2. Press the **Action on TRG** soft key.
  3. Press the **Telecom Test** soft key.
  4. Press the **Condition** soft key.
- **Selecting the Determination Condition Number**
    5. Press the **Select** soft key.
    6. Select the determination condition number. Press the soft key corresponding to the number.

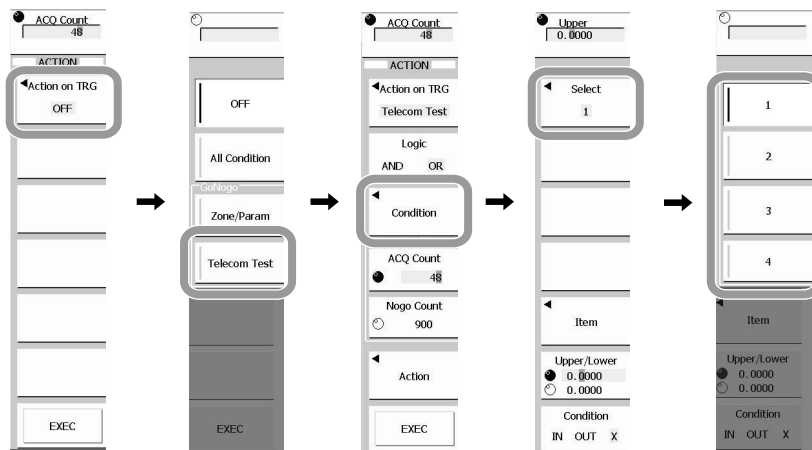

• **Setting the Item**

7. Press the **Item** soft key. The item setting menu appears.
8. Press the soft key corresponding to the element to be set.
9. With the rotary knob, move the cursor to the item, from Wave Count, Wave Count %, Sample Point Count, and Sample Point Count %, to be set for the GO/NO-GO determination.
10. Press **SET**. This places a check mark in the checkbox.
11. Repeat steps 8 to 10 as required, to set other elements.

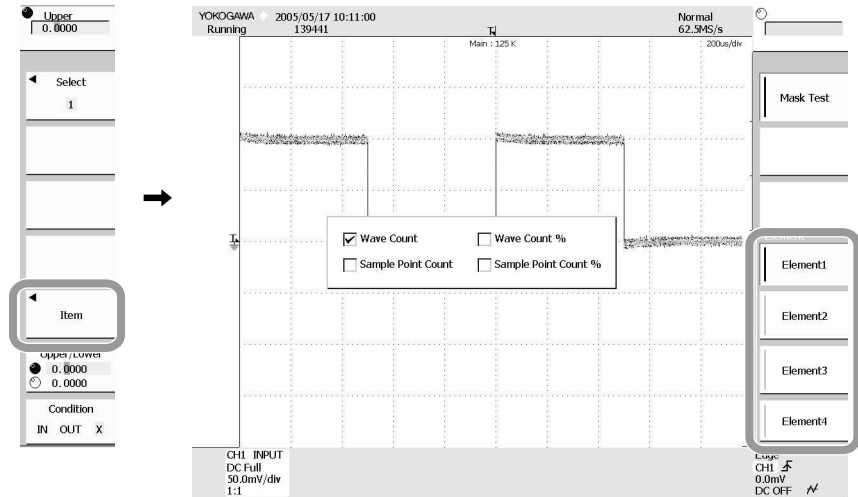

• **Setting the Determination Range**

12. Press the **Upper/Lower** soft key, and select the item for which the range is to be set.
13. With the **rotary knob**, select Upper or Lower.

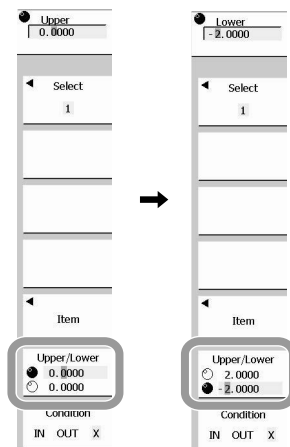

## 7.16 Setting the Telecom Test GO/NO-GO Determination Conditions

---

- **Selecting the Determination Criterion**
  14. Press the **Condition** soft key, and select IN, OUT, or X.
  15. Press **ESC**, and return to the GO/NO-GO menu.

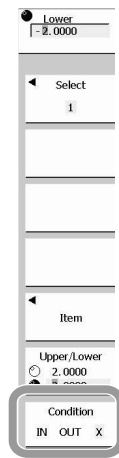

If necessary, repeat the steps above for the determination condition numbers 1 to 4.

### Explanation

Using the telecom test parameters, the GO/NO-GO determination is based on being within the range or outside the range.

#### Determination Condition: Condition

- **Setting the Determination Condition: Select**

Select the number of the determination condition for the determination condition to be set. Each of four determination conditions can be set.
- **Selecting the Item: Item**

The following items can be set for each of Element1 to Element4.

  - Wave Count: Error count of acquisition
  - Wave Count %: Error rate with respect to acquisition count
  - Sample Point Count: Error count of sample data for the element
  - Sample Point Count %: Error rate with respect to number of data samples for the element
- **Setting the Determination Range: Upper/Lower**

Set upper and lower limits for the value of the specified determination item.
- **Selecting the Determination Criterion: Condition**
  - IN: When the value of the item in the determination is within the range of upper and lower limits, this is a NO-GO result.
  - OUT: When the value of the item in the determination is outside the range of upper and lower limits, this is a NO-GO result.
  - X: The GO/NO-GO determination is not made.

#### Note

Because the sample point count is calculated using interpolated data, it may not display a value corresponding to the record length.

---

# 8.1 Changing the Display Format

## Procedure



### Setting the Display Format

1. Press **FORM**. The Format menu appears.
2. Press the **VT Form** soft key.
3. Press the soft key for the desired format, from **Single** through **Quad**.

### Setting the Waveform Mapping

4. Press the **Mapping** soft key.
5. Select either Auto or Manual. If you select Auto, proceed to step 8.
6. Press the desired channel from among CH1 to CH4 and M1 to M4. To select M1 to M4, first switch press the **M1-M4** soft key.
7. Select the area to display the selected waveform.
8. Press **ESC**.

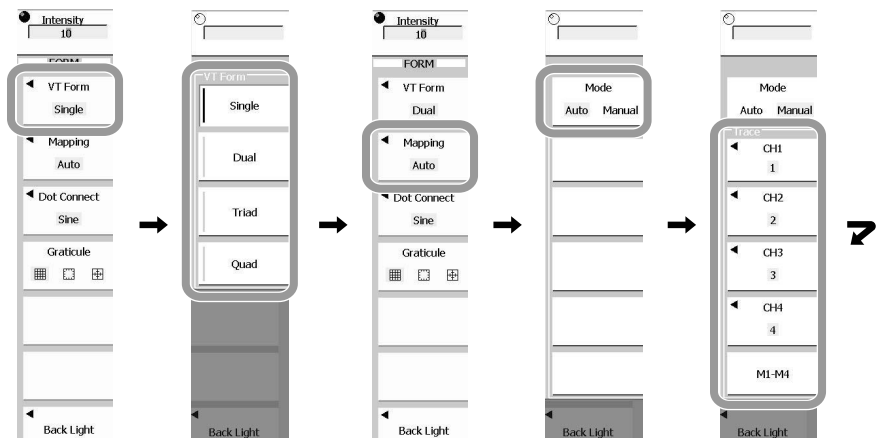

### Mapping: When Manual is selected

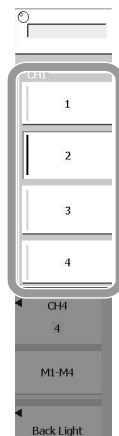

## 8.1 Changing the Display Format

---

### Explanation

Select the number of windows for displaying the analog waveforms. The position for the waveform of each channel varies depending on the display format.

#### Display Format

Single: 1 window                      Triad: 3 windows  
Dual: 2 windows                        Quad: 4 windows

#### Waveform Mapping

- **Auto**

The waveforms are mapped in the order CH1, CH2, CH3, CH4, M1, M2, M3, and M4, from the top of the divided screen. When the mapping reaches the bottom of the divided screen it begins again from the top. Channels with displays that are turned OFF are excluded.

- **Manual**

Specify where to map CH1 to CH4 and M1 to M4.

The number of points that can be displayed within 8 div vertically depends on the display format (when the Main window only is displayed). The vertical resolution remains unchanged.

Single(□): 640 points                      Triad(☐): 208 points  
Dual(☐): 320 points                        Quad(☐): 160 points

## 8.2 Setting the Interpolation Method

### Procedure

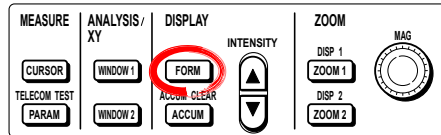

1. Press **FORM**.

### Setting the Interpolation Method

2. Press the **Dot Connect** soft key.
3. Press the **OFF**, **Pulse**, **Line**, or **Sine** soft key to select the interpolation method.

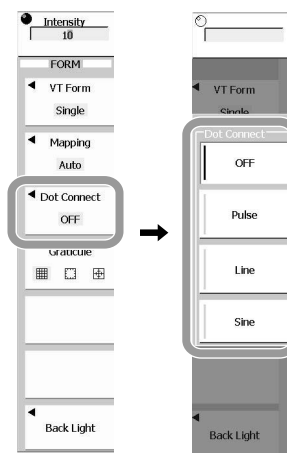

### Explanation

#### Setting the Interpolation Method: Dot Connect

Set the method by which sampled data are connected to display the waveform. If the Main and ZOOM1 or ZOOM2 display record length is as follows, the sampled data are only connected in the vertical direction. There is no difference between Sine, Line, and Pulse.

- 4 kWord, 5 kWord
- 10 kWord or higher

If the display record length is higher than the above, new interpolation points are generated between sampled data according to the specified interpolation method, and the interpolation points are connected in the vertical axis direction.

Sine: Interpolates between two points using the  $(\sin x)/x$  function.

Line: Linearly interpolates between two points.

Pulse: Interpolates between two points by drawing a horizontal line to the time of the next data point, then connecting the end of the horizontal line to the next data point with a vertical line.

OFF: No interpolation.

#### Interpolation Image

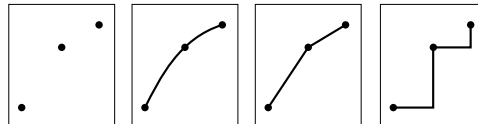

Dot Connect:    OFF            Sine            Line            Pulse



## 8.3 Changing the Graticule

### Procedure

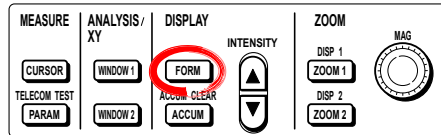

1. Press **FORM** to display the FORM menu.
2. Press the **Graticule** soft key to select the graticule.

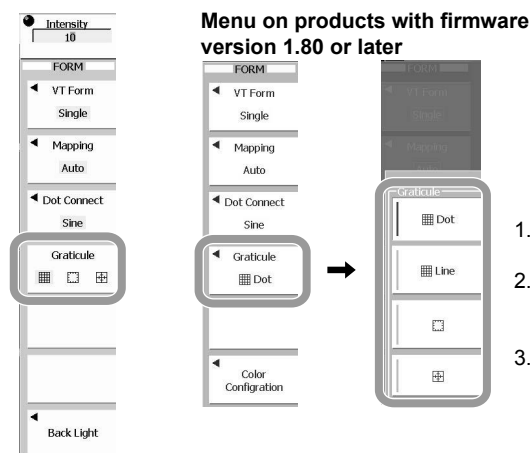

1. Press **FORM** to display the FORM menu.
2. Press the **Graticule** soft key. The Graticule menu appears.
3. Press the soft key corresponding to the graticule you wish to display.

### Explanation

Select from the following four types. The line setting can be used on products with firmware version 1.80 or later.

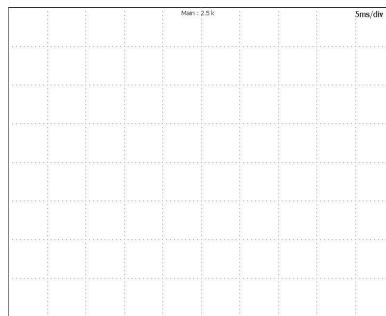

Dot

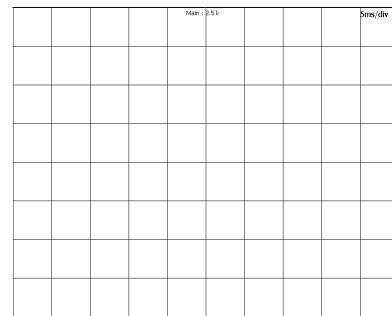

Line

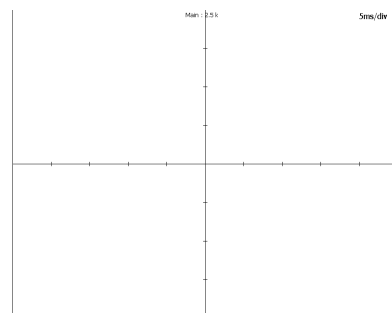
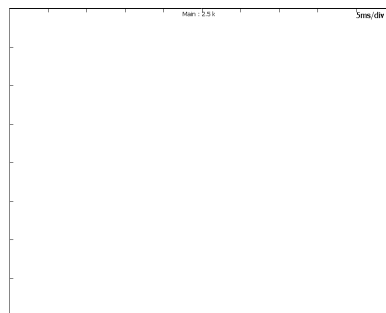

## 8.4 Adjusting the Backlight

### Procedure

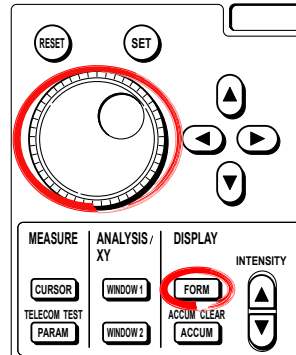

1. Press **FORM**.
2. Press the **Back Light** soft key. The LCD menu appears.

### Setting Auto OFF for the Backlight

3. Press the **Auto OFF** soft key to select ON or OFF.  
If you select ON, continue with step 4.
4. Push the **Time Out** soft key to view the rotary knob.
5. Use the **rotary knob** to set the time when the backlight automatically goes off.

### Setting the Backlight Brightness

6. Push the **Brightness** soft key to view the rotary knob.
7. Use the **rotary knob** to set the backlight brightness.

### Turning the Backlight ON/OFF

8. Press the **LCD OFF** soft key. The backlight turns OFF.  
Press any key to return to the measurement screen.

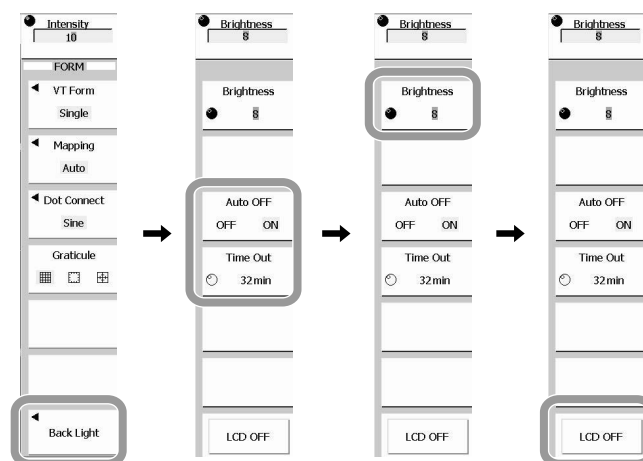

**Explanation****Setting Auto OFF for the Backlight: Auto OFF, Time Out**

The backlight automatically turns OFF if there is no panel key operation for the specified time.

If any key is pressed the backlight turns ON.

**Setting the Backlight Brightness: Brightness**

You can change the brightness of the backlight. Set it in the range from 1 (dark) to 8 (bright).

You can prolong the lifetime of the backlight by setting it to dark or turning it off when screen observation is not necessary.

**Turning the Backlight ON/OFF: LCD OFF**

You can turn the LCD backlight ON/OFF. If any key is pressed when the backlight is turned OFF, it turns ON.

## 8.5 Setting Waveform Labels

### Procedure

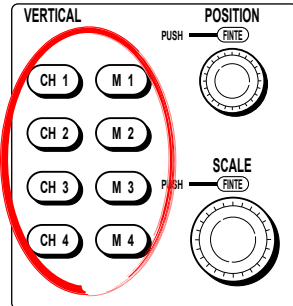

1. Press one of the **CH1** to **CH4** or **M1** to **M4** keys to select the channel.
2. Press the **Next 1/2** soft key.
3. Press the **Label** soft key.

### Turning the Waveform Label Display ON/OFF

4. Press the **Trace Label** (waveform label) soft key to select ON or OFF.

### Setting the Waveform Label

5. Press the **Define Label** soft key. A keyboard appears.
6. Input the waveform label according to the procedure given in section 4.2.
7. When input is complete, press **ESC**.

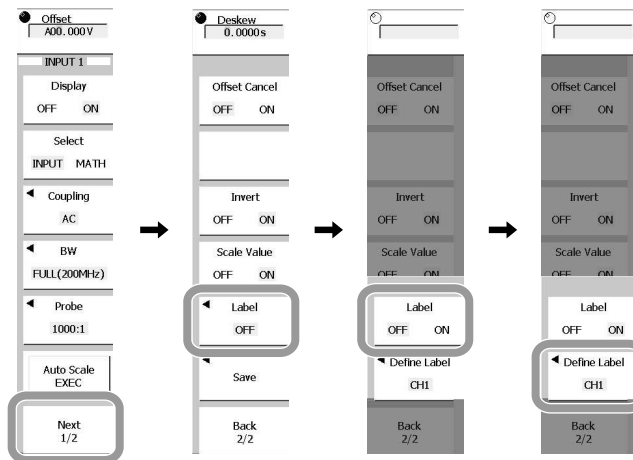

### Explanation

#### Setting the Waveform Label: Define Label

You can set the waveform label of each channel using up to eight characters.

#### Turning the Waveform Label Display ON/OFF: Label

You can select whether to display the channel for the displayed waveform.

#### Note

The waveform label may not be displayed if the waveform area is small, depending on the display format and zoom format.

## 8.6 Taking and Clearing Snapshots

### Procedure

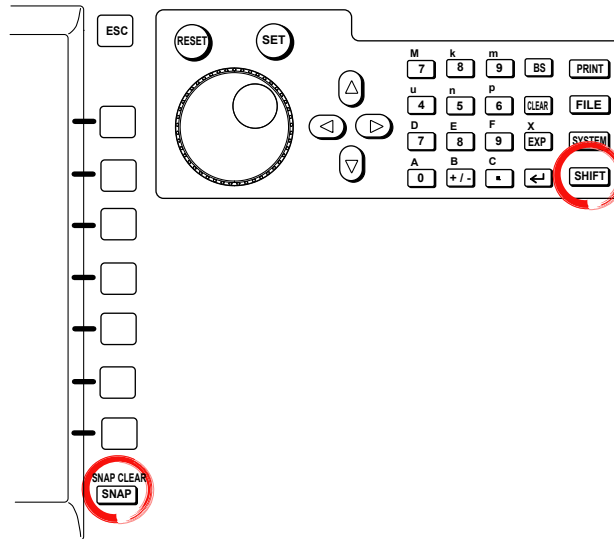

#### Taking a Snapshot

Press **SNAP**. The snapshot is taken.

#### Clearing a Snapshot

Press **SHIFT + SNAP**. The waveform is cleared.

### Explanation

#### Snapshot

The snapshot function keeps the current displayed waveform on the screen. You can update the display without stopping the waveform acquisition. This function is useful in situations such as when you wish to compare waveforms.

- You cannot perform the following operations on snapshot waveforms.  
Cursor measurements, automated measurement of waveform parameters, zoom, and computation
- Snapshot waveforms can be saved and loaded in bitmap format. (See section 13.8.)

#### Clearing Snapshots

- Clears all the snapshot waveforms that are currently displayed on the screen.

#### Conditions That Disable the SNAP and SNAP CLEAR Keys

- When printing, during auto setup, and while the storage medium is being accessed.
- When GO/NO-GO determination, action-on-trigger, or waveform search is in progress.

## 8.7 Setting the Waveform Display Color and the Brightness of the Grid, Zoom Box, Cursor, and Marker

### Procedure

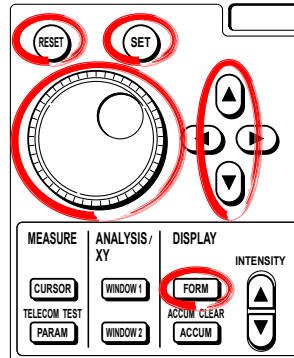

1. Press the **FORM** soft key.
2. Press the **Color Configuration** soft key.

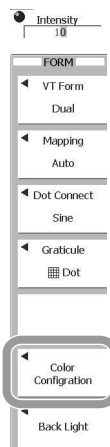

### Setting the Waveform Display Color

3. Press the **Waveform** soft key to display the Waveform menu.
4. Press the **CH1 to CH4, REF1-REF4, MATH1-MATH4** soft key to select the waveform of which you wish to change the color.
  - Pressing the REF1-REF4 soft key opens the REF1, REF2, REF3, and REF4 soft keys.
  - Pressing the MATH1-MATH4 soft key opens the MATH1, MATH2, MATH3, and MATH4 soft keys.
5. Turn the **rotary knob** or **up and down arrow keys** to select the display color.
6. Press **SET** to confirm the color.

To reset to the default value, press **RESET**. Only the brightness of the waveform selected in step 4 is reset to its default value.

## 8.7 Setting the Waveform Display Color and the Brightness of the Grid, Zoom Box, Cursor, and Marker

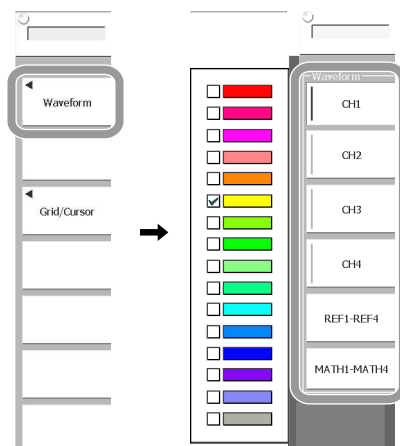

### Setting the Brightness of the Grid, Zoom Box, Cursor, and Marker

3. Press the **Grid/Cursor** soft key.
4. Press any of the **Grid, Zoom Box, Cursor, and Marker** soft keys to select the item of which you wish to change the brightness.
5. Turn the **rotary knob** to set the brightness.  
To reset to the default value, press **RESET**. Only the brightness of the item selected in step 4 is reset to its default value.

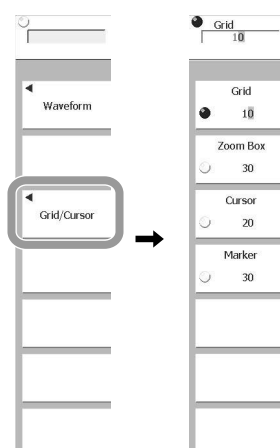

### Explanation

You can set the waveform display color and the brightness of the grid, zoom box, cursor, and marker. This function can be used on products with firmware version 1.80 or later.

### Setting the Waveform Display Color

- The waveform color of input waveforms CH1 to CH4\*, reference waveforms REF1 to REF4, and computation waveforms MATH1 to MATH4 can be selected from 16 colors.
  - \* If computation waveforms are assigned to input channels, CH1 to CH4 correspond to MATH5 to MATH8, respectively. And, the colors of CH1 to CH4 are assigned to the corresponding computation channels.
- On products with firmware version 3.6 or later, this waveform color setting also applies to the title bar color of the menu that appears when a channel key is pressed.

### Setting the Brightness of the Grid, Zoom Box, Cursor, and Marker

You can set the brightness of the grid, zoom box, cursor, and marker.

Selectable range: 0 to 31

### Resetting

Press **RESET** to reset the waveform display color or the brightness of the grid, zoom box, cursor, or marker to the default value.

# 9.1 Linear Scaling

## Procedure

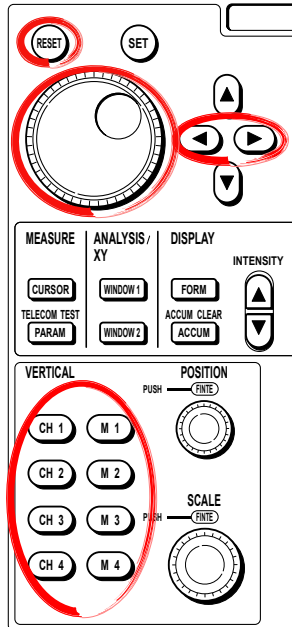

1. Press one of the **CH1** to **CH4** or **M1** to **M4** keys to select the channel.
2. Press the **Select** soft key and select **MATH**.

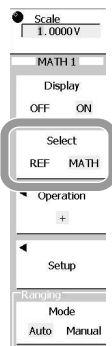

### Selecting the Operator

3. Press the **Operation** soft key.
4. Press the **Filter** soft key.

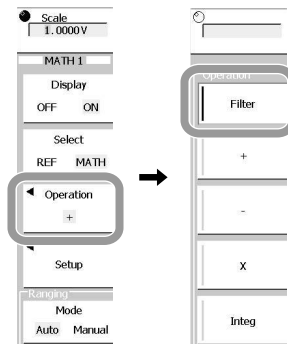



**Setting the Operation**

5. Press the **Setup** soft key.

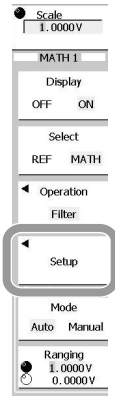

• **Setting the Waveform To Be Computed**

6. Press the **Source** soft key. A menu used to select the waveform to be computed appears.

When CH1 to CH4 on the front panel are set, the waveform to be computed is fixed to the channel that is set. A menu used to select the waveform to be computed don't appears. Proceed to step 8.

7. Press the soft key corresponding to the target waveform.

To select REF1 to REF4, first switch to **REF1-REF4** by pressing the corresponding soft key.

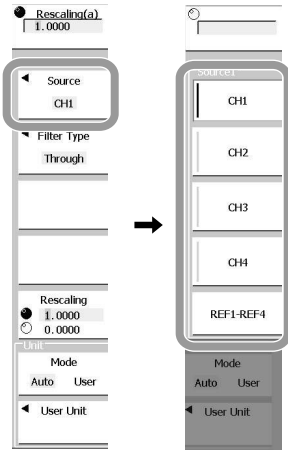

• **Setting the Filter Type**

8. Press the **Filter Type** soft key.
9. Press the **Through** soft key.

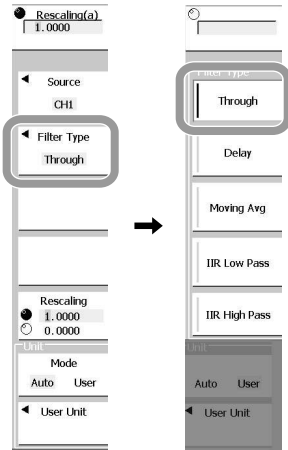

• **Setting Scalling for the Operation Results**

10. Press the **Rescaling** soft key.
11. Turn the **rotary knob** and set a and b in the linear scaling equation  $y = ax + b$ .  
Pressing RESET resets the values.  
You can use the arrow keys to move the digit that is currently being set.

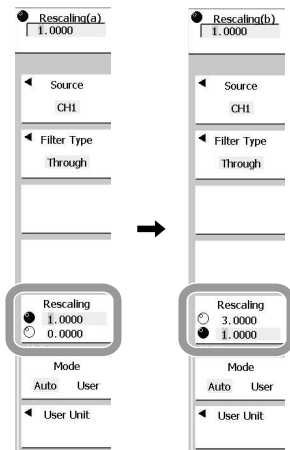

**Setting the Unit**

12. Press the **Mode** soft key to select Auto or User.  
If Auto is selected, proceed to step 15.
13. Press the **User Unit** soft key.
14. See section 4.2. Enter the unit and press the **Enter** soft key.
15. Press **ESC**.

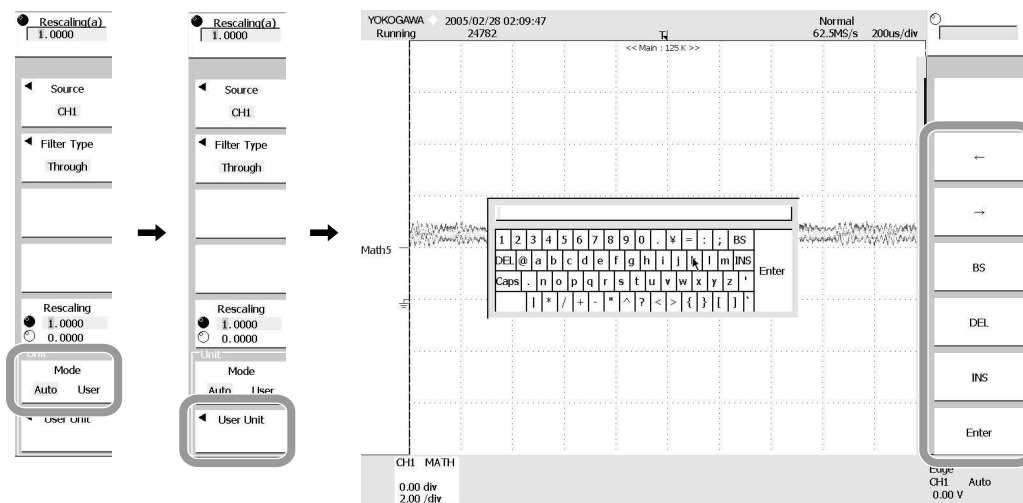

**Scale Conversion (setting the display range)**

16. Press the **Mode** soft key to select Auto or Manual.
17. If Manual is selected, press the **Ranging** soft key and use the rotary knob to set the voltage per division and the center position voltage.

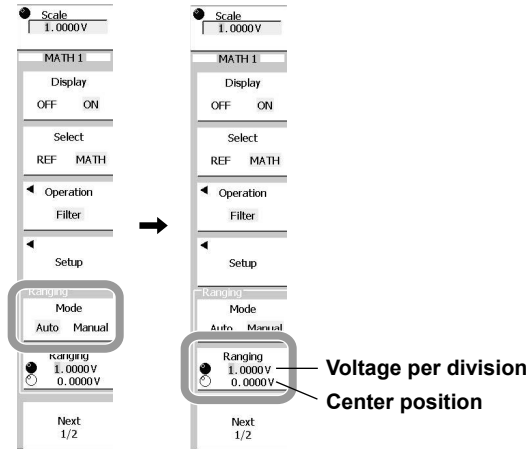

**Explanation**

Using the set scaling factor A and offset value B, the following expression is evaluated, and the scaled value obtained is used to display cursor measurement values and values from automatic waveform parameter measurement. It is also possible to add a unit indication to the scaled value.

$$Y = AX + B \text{ (X = measured value; Y = linear scaling result)}$$

**Setting Scaling Coefficient A and Offset Value B**

Selectable range of A and B	-10.000E+30 to +10.000E+30
Default settings	A 1.0000E+00 B 0.0000E+00

**Waveform to Be Computed**

Select from among CH1 to CH4, or REF1 to REF4. When CH1 to CH4 on the front panel are used for operation, the waveform to be computed is fixed to the channel that is being operated.

**Scale Conversion (Ranging)**

Set the waveform display range.

- Auto:** The waveform display range is automatically determined based on the V/div, operator, offset value, etc., of the target waveform.
- Manual:** The waveform display range is determined based on the setting of the voltage per division and the center position voltage on the screen. If the operator is changed, the Auto display range changes automatically in accordance with the operator that was changed. The mode remains set to Manual.

**Unit**

- Auto:** Uses the initial value.  
Initial value: V, A, VV, AA, VA
- User:** A character string of up to four characters can be set.

**Displaying the Scale Value**

The upper and lower limits of the vertical axis of each channel can be displayed using scaled values (the Ranging function). For the procedure of displaying scale values (see section 5.12).

## 9.2 Performing Arithmetic Functions

### Procedure

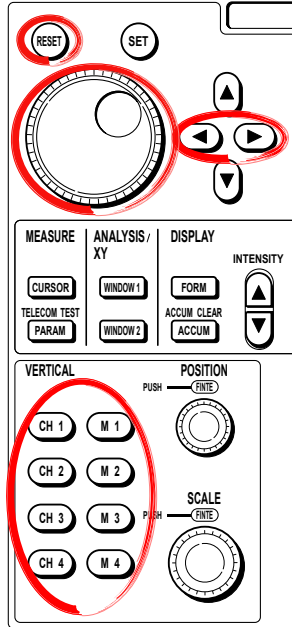

1. Press one of the **CH1** to **CH4** or **M1** to **M4** keys to select the channel.
2. Press the **Select** soft key and select **MATH**.

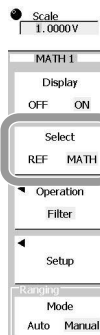

### Selecting the Operator

3. Press the **Operation** soft key.
4. Select the operator from among CH1 **+**, **-**, or **x** and press the corresponding soft key.

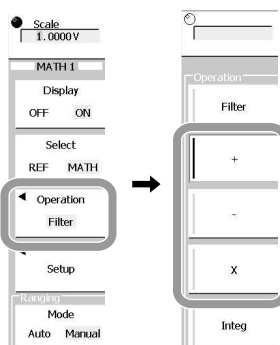

**Setting the Operation**

5. Press the **Setup** soft key.

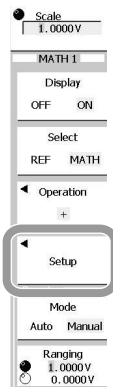

• **Selecting the Target Waveform**

6. Press the **Source1** soft key. A menu used to select the waveform to be computed appears.

When CH1 to CH4 on the front panel are set, the waveform to be computed is fixed to the channel that is set. A menu used to select the waveform to be computed don't appears. Proceed to step 8.

7. Press the soft key corresponding to the target waveform.

To select REF1 to REF4, first switch to **REF1-REF4** by pressing the corresponding soft key.

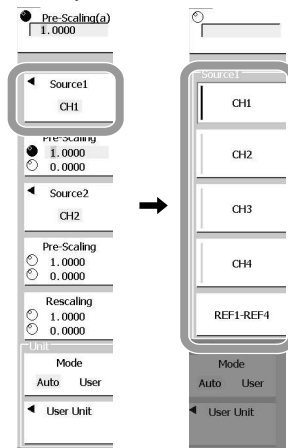

8. Press the **Source2** soft key.
9. Press the soft key corresponding to the target channel.

To select REF1 to REF4, first switch to **REF1-REF4** by pressing the corresponding soft key.

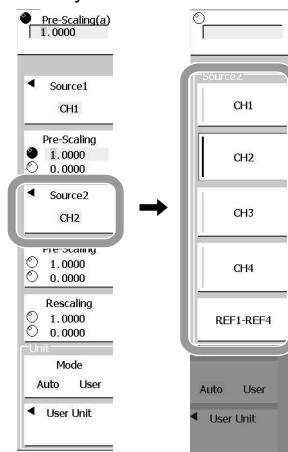

• **Setting Pre-Scaling**

10. Press the **Pre-Scaling** soft key corresponding Source 1 or Source 2 as necessary in order to set the rotary knob target.
11. Turn the **rotary knob** and set a and b in the scaling equation  $y = ax + b$ .  
Pressing RESET resets the values.  
You can use the arrow keys to move the digit that is currently being set.
12. Repeat steps 10 and 11 as necessary, setting Source 1 and Source 2.

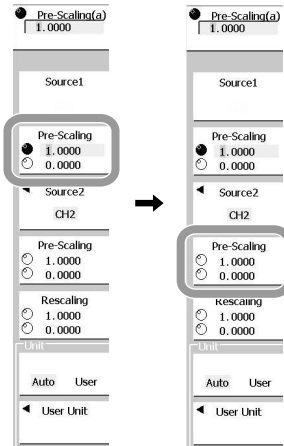

• **Setting Scaling for the Operation Results**

13. Press the **Rescaling** function if necessary.
14. Turn the **rotary knob** and set a and b in the scaling equation  $y = ax + b$ .  
Pressing RESET resets the values.  
You can use the arrow keys to move the digit that is currently being set.

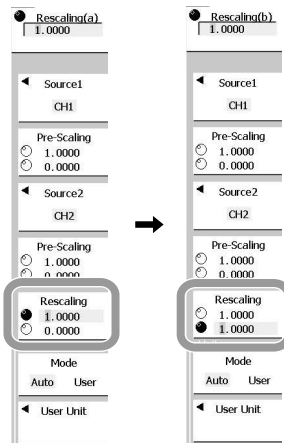

## 9.2 Performing Arithmetic Functions

### Setting the Unit

15. Press the **Mode** soft key to select Auto or User.
- If you select Auto, proceed to step 18.
16. Press the **User Unit** soft key.
17. See section 4.2. Enter the unit and press the **Enter** soft key.
18. Press **ESC**.

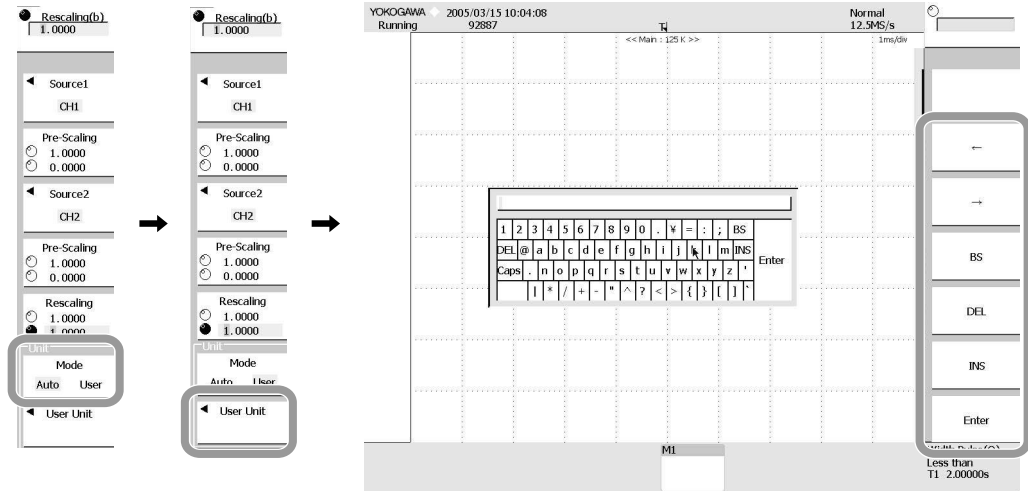

### Ranging (setting the display range)

19. Press the **Mode** soft key to select Auto or Manual.
20. If Manual is selected, press the **Ranging** soft key and use the rotary knob to set the voltage per division and the center position voltage.

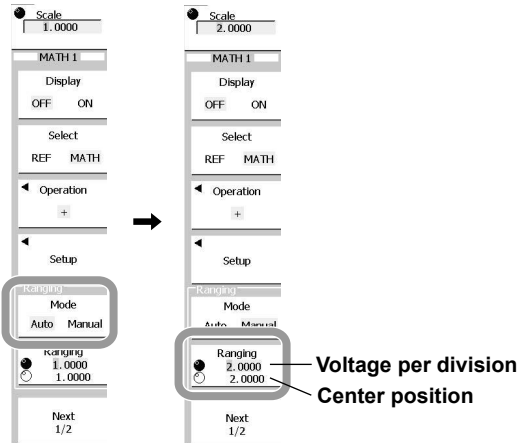

**Explanation**

The arithmetic operation is performed on the specified trace waveform.

**Waveform to Be Computed: Source1/Source2**

Select from among CH1 to CH4, or REF1 to REF4. When CH1 to CH4 on the front panel are used for operation, the waveform to be computed is fixed to the channel that is being operated.

**Scaling Prior To the Operation: Pre-Scaling**

This sets scaling on pre-operation values for individual sources.

**Scaling Computed Results: Rescaling**

This sets scaling on computed results.

**Unit**

Auto: Uses the initial value.

Initial value: V, A, VV, AA, VA

User: A character string of up to four characters can be set.

**Ranging**

Set the waveform display range.

Auto: The waveform display range is automatically computed based on the V/div, operator, offset value, etc., of the target waveform.

Manual: The waveform display range is determined based on the setting of the voltage per division and the center position voltage on the screen.  
If the operator is changed, the Auto display range changes automatically in accordance with the operator that was changed. The mode remains set to Manual.



## 9.3 Integrating

### Procedure

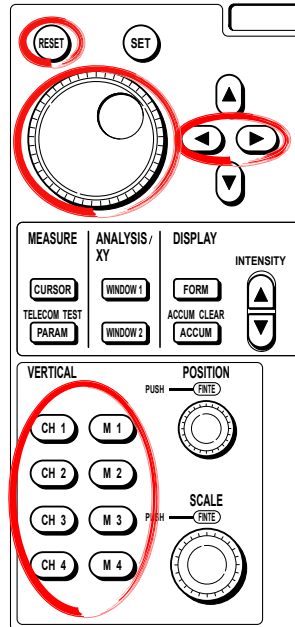

1. Press one of the **CH1** to **CH4** or **M1** to **M4** keys to select the channel.
2. Press the **Select** soft key and select **MATH**.

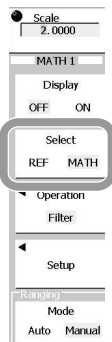

#### Selecting the Operator

3. Press the **Operation** soft key.
4. Press the **Next 1/2** soft key.
5. Press the **Integ** soft key.

#### If the Channel Is M1

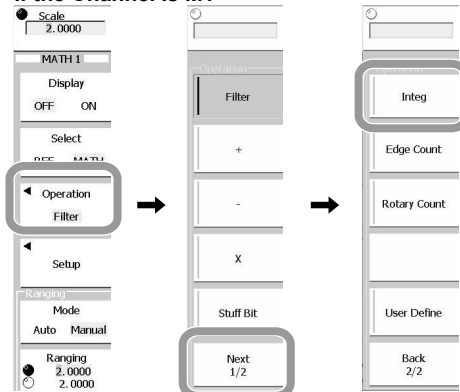

### Setting the Operation

- Press the **Setup** soft key.

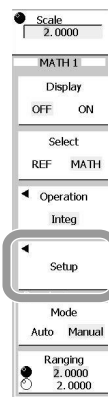

- Setting the Target Waveform for the Operation

- Press the **Source** soft key. A menu used to select the waveform to be computed appears.

When CH1 to CH4 on the front panel are set, the waveform to be computed is fixed to the channel that is set. A menu used to select the waveform to be computed don't appears. Proceed to step 9.

- Press the soft key corresponding to the target waveform.

To select REF1 to REF4, first switch to **REF1-REF4** by pressing the corresponding soft key.

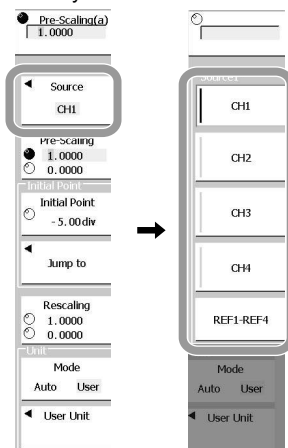

- Setting the Input Source Scaling Prior to the Operation

- Press the **Pre-Scaling** soft key and change the rotary knob target.
- Turn the **rotary knob** to set pre-scaling.

Pressing RESET resets the values.

You can use the arrow keys to move the digit that is currently being set.

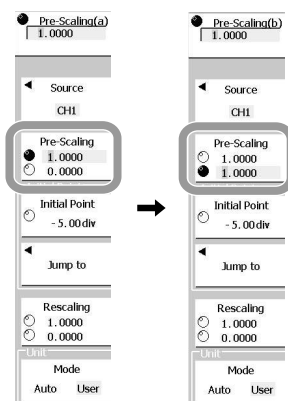

- **Setting the Operation Initial Point**

11. Press the **Initial Point** soft key.
12. Either turn the **rotary knob** to set the initial point, or else press the Jump to soft key.
13. If you pressed the Jump to soft key, select the Jump destination. Press the Jump destination soft key.

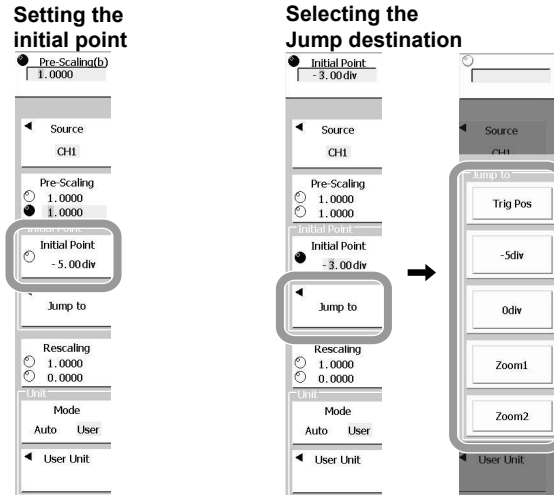

- **Setting Scaling for the Operation Results**

14. Press the **Rescaling** soft key.
15. Turn the **rotary knob** to set rescaling. Pressing RESET resets the values. You can use the arrow keys to move the digit that is currently being set.

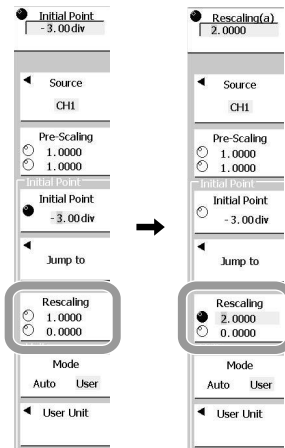

### Setting the Unit

16. Press the **Mode** soft key to select Auto or User.  
If you select Auto, proceed to step 19.
17. Press the **User Unit** soft key.
18. See section 4.2. Enter the unit and press the **Enter** soft key.
19. Press **ESC**.

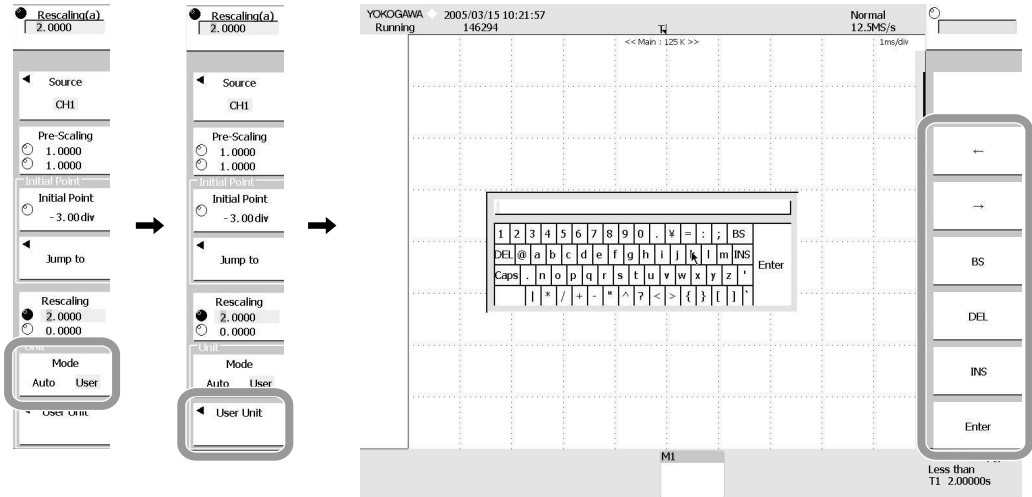

### Ranging (setting the display range)

20. Press the **Mode** soft key to select Auto or Manual.
21. If Manual is selected, press the **Ranging** soft key and use the rotary knob to set the voltage per division and the center position voltage.

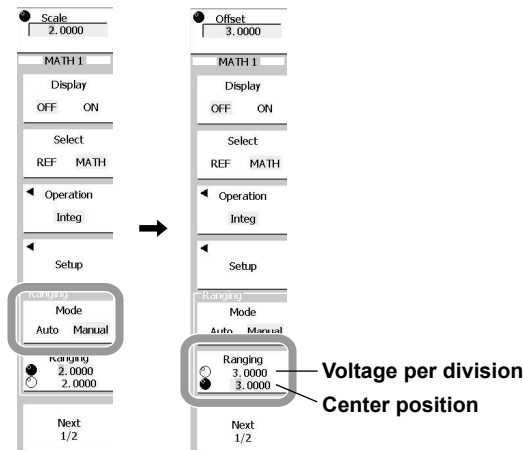

### Explanation

The specified trace waveform is integrated.

#### **Operation Target Waveform: Source**

Select from among CH1 to CH4, or REF1 to REF4. When CH1 to CH4 on the front panel are used for operation, the waveform to be computed is fixed to the channel that is being operated.

#### **Setting the Operation Initial Point: Initial Point**

Set the initial point of the operation.

- Item: -5 div to 5 div
- Initial value for div resolution: -5 div

The following points can be set directly (Jump to).

Trig Pos (trigger position), -5 div, 0 divisions, Zoom1 (Center of Zoom 1 enlarged position), Zoom2 (Center of Zoom 2 enlarged position)

#### **Scaling Computed Results: Rescaling**

This sets scaling on computed results.

#### **Unit**

Auto: Uses the initial value.

Initial value: Vs, As, VVs, AAs, VAs

User: A character string of up to four characters can be set.

#### **Ranging**

Set the waveform display range.

Auto: The waveform display range is automatically computed based on the V/div, operator, offset value, etc., of the target waveform.

Manual: The waveform display range is determined based on the setting of the voltage per division and the center position voltage on the screen.

If the operator is changed, the Auto display range changes automatically in accordance with the operator that was changed. The mode remains set to Manual.

## 9.4 Shifting the Phase

### Procedure

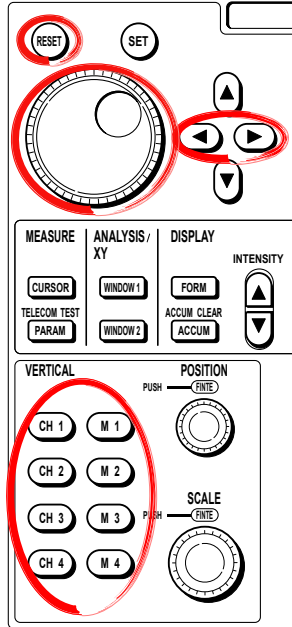

1. Press one of the **CH1** to **CH4** or **M1** to **M4** keys to select the channel.
2. Press the **Select** soft key and select **MATH**.

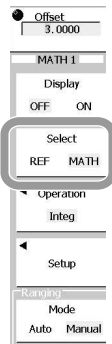

### Selecting the Operator

3. Press the **Operation** soft key.
4. Press the **Filter** soft key.

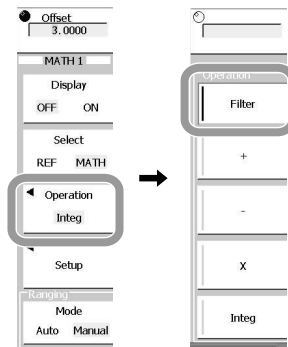

**Setting the Operation**

5. Press the **Setup** soft key.

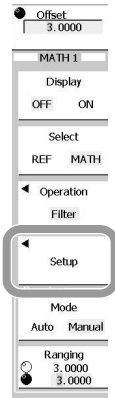

• **Selecting the Target Waveform**

6. Press the **Source** soft key. A menu used to select the waveform to be computed appears.

When CH1 to CH4 on the front panel are set, the waveform to be computed is fixed to the channel that is set. A menu used to select the waveform to be computed don't appears. Proceed to step 8.

7. Press the soft key corresponding to the target waveform.

To select REF1 to REF4, first switch to **REF1-REF4** by pressing the corresponding soft key.

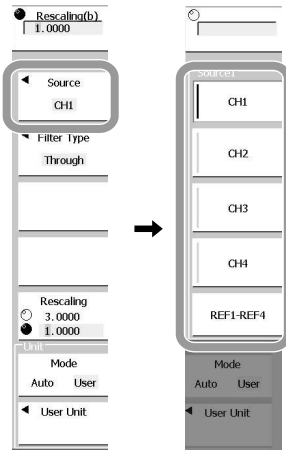

• **Setting the Filter Type**

8. Press the **Filter Type** soft key.
9. Press the **Delay** soft key.

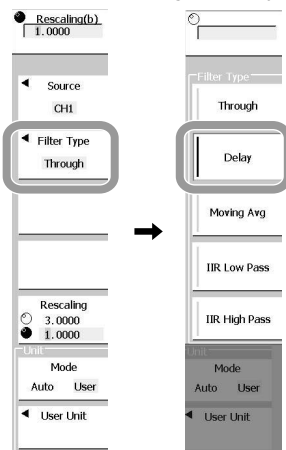

- **Setting the Time for Shifting the Phase**

10. Press the **Delay** soft key and change the rotary knob target.
11. Turn the **rotary knob** and set the time for shifting the waveform phase.  
Pressing RESET resets the values.  
You can use the arrow keys to move the digit that is currently being set.

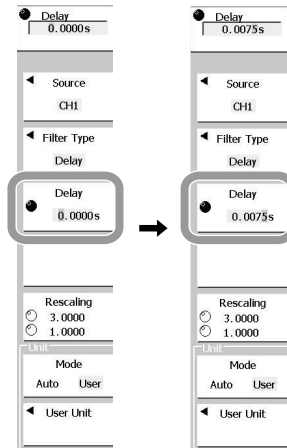

- **Setting Scaling for the Operation Results**

12. Press the **Rescaling** soft key.
13. Turn the **rotary knob** to set rescaling.  
Pressing RESET resets the values.  
You can use the arrow keys to move the digit that is currently being set.

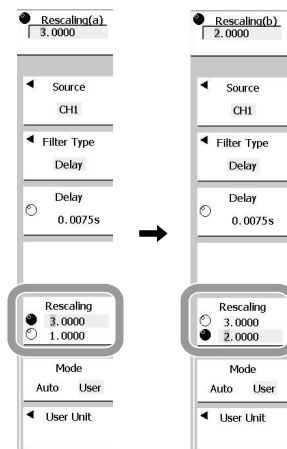



**Setting the Unit**

14. Press the **Mode** soft key to select Auto or User.
- If you select Auto, proceed to step 17.
15. Press the **User Unit** soft key.
16. See section 4.2. Enter the unit and press the **Enter** soft key.
17. Press **ESC**.

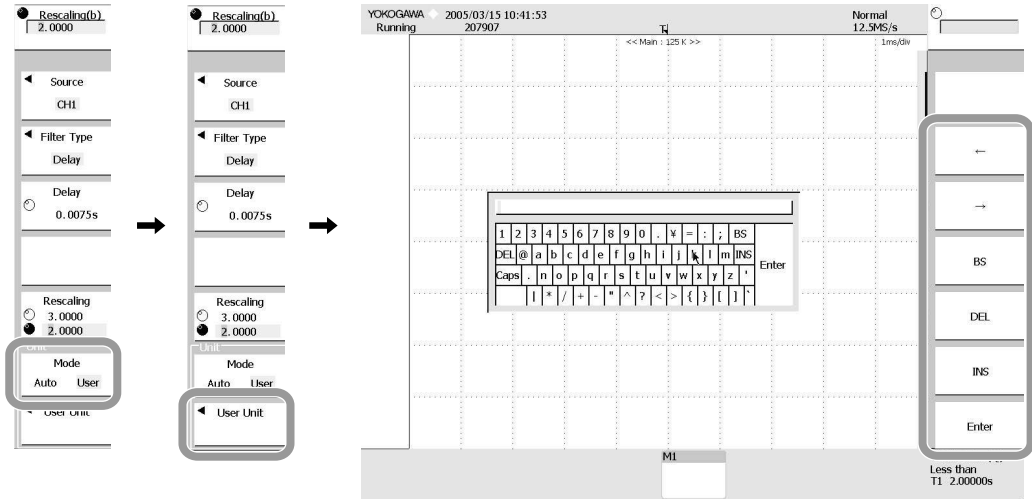

**Ranging (setting the display range)**

18. Press the **Mode** soft key to select Auto or Manual.
19. If Manual is selected, press the **Ranging** soft key and use the rotary knob to set the voltage per division and the center position voltage.

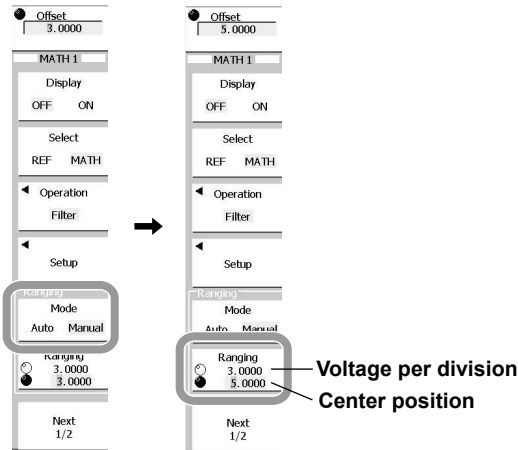

**Explanation**

The target waveform can be displayed with phase shift.

**Waveform to Be Computed**

Select from among CH1 to CH4, or REF1 to REF4. When CH1 to CH4 on the front panel are used for operation, the waveform to be computed is fixed to the channel that is being operated.

**Setting the Delay Time: Delay**

The delay can be set over a range equivalent to  $\pm 5$  divisions.

**Scaling Computed Results: Rescaling**

This sets scaling on computed results.

**Unit**

Auto: Uses the initial value.

Initial value: V, A, VV, AA, VA

User: A character string of up to four characters can be set.

**Ranging**

Set the waveform display range.

Auto: The waveform display range is automatically computed based on the V/div, operator, offset value, etc., of the target waveform.

Manual: The waveform display range is determined based on the setting of the voltage per division and the center position voltage on the screen.

If the operator is changed, the Auto display range changes automatically in accordance with the operator that was changed. The mode remains set to Manual.

## 9.5 Setting a Filter (IIR Filter)

### Procedure

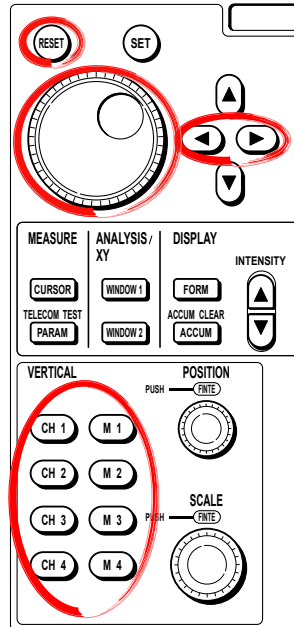

1. Press one of the **CH1** to **CH4** or **M1** to **M4** keys to select the channel.
2. Press the **Select** soft key and select **MATH**.

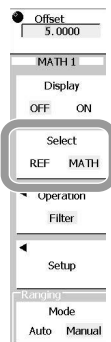

### Selecting the Operator

3. Press the **Operation** soft key.
4. Press the **Filter** soft key.

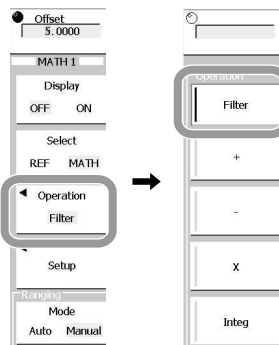

**Setting the Operation**

5. Press the **Setup** soft key.

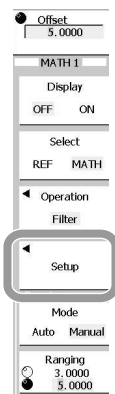

• **Selecting the Target Waveform**

6. Press the **Source** soft key. A menu used to select the waveform to be computed appears.

When CH1 to CH4 on the front panel are set, the waveform to be computed is fixed to the channel that is set. A menu used to select the waveform to be computed don't appears. Proceed to step 8.

7. Press the soft key corresponding to the target waveform.

To select REF1 to REF4, first switch to **REF1-REF4** by pressing the corresponding soft key.

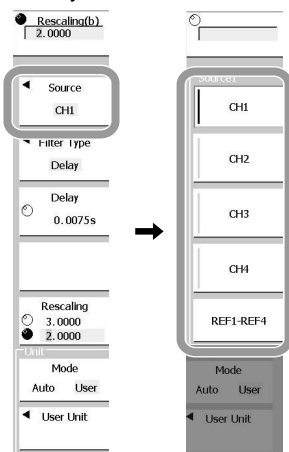

• **Setting the Filter Type**

8. Press the **Filter Type** soft key.
9. Press the **IIR Low Pass** or **IIR High Pass** soft key.

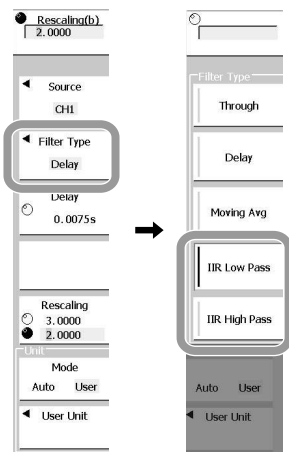

## 9.5 Setting a Filter (IIR Filter)

- **Setting the Cutoff Frequency**

10. Press the **Cut off** soft key and change the rotary knob target.

11. Turn the **rotary knob** to set the cutoff frequency.

Pressing RESET resets the values.

You can use the arrow keys to move the digit that is currently being set.

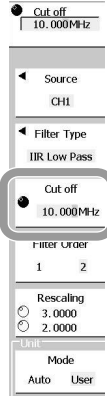

- **Selecting the Filter Order**

12. Press the **Filter Order** soft key to select 1 or 2.



- **Setting Scaling for the Operation Results**

13. Press the **Rescaling** soft key.

14. Turn the **rotary knob** to set rescaling.

Pressing RESET resets the values.

You can use the arrow keys to move the digit that is currently being set.

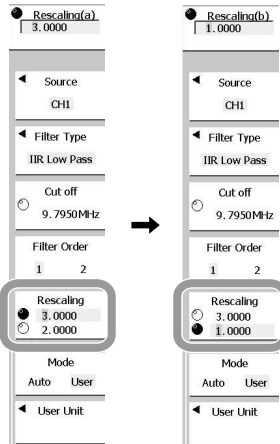

**Setting the Unit**

15. Press the **Mode** soft key to select Auto or User.  
If you select Auto, proceed to step 18.
16. Press the **User Unit** soft key.
17. See section 4.2. Enter the unit and press the **Enter** soft key.
18. Press **ESC**.

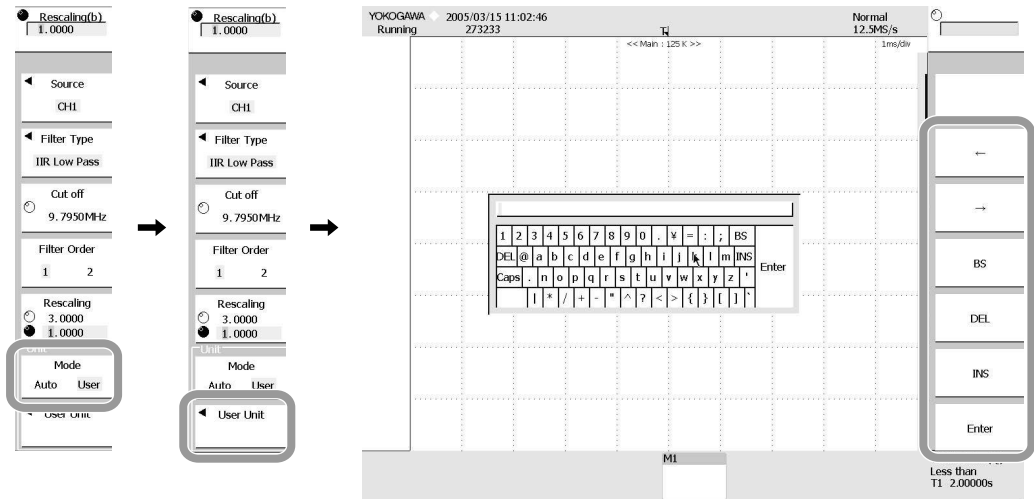

**Ranging (setting the display range)**

19. Press the **Mode** soft key to select Auto or Manual.
20. If Manual is selected, press the **Ranging** soft key and use the rotary knob to set the voltage per division and the center position voltage.

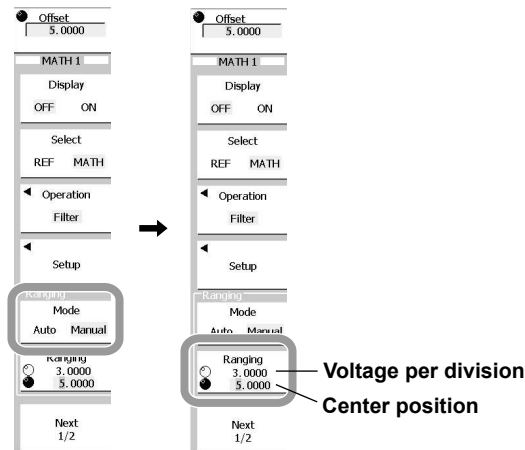

## 9.5 Setting a Filter (IIR Filter)

---

### Explanation

Low Pass Filter and High Pass Filter can be set by combining a temporary low pass filter and a differentiator.

### Waveform to Be Computed

Select from among CH1 to CH4, or REF1 to REF4. When CH1 to CH4 on the front panel are used for operation, the waveform to be computed is fixed to the channel that is being operated.

### Setting the Cutoff Frequency: Cut off

Can be set to a value up to 1 GHz.

### Selecting the Filter Order: Filter Order

The setting differs, depending on the specified filter type.

Filter Type	Filter order	Phase change
High Pass	1	The phase advances.
Low Pass	1	The phase is delayed.
High Pass/Low Pass	2	Phase 0

### Scaling Computed Results: Rescaling

This sets scaling on computed results.

### Unit

Auto: Uses the initial value.

Initial value: V, A, VV, AA, VA

User: A character string of up to four characters can be set.

### Ranging

Set the waveform display range.

Auto: The waveform display range is automatically computed based on the V/div, operator, offset value, etc., of the target waveform.

Manual: The waveform display range is determined based on the setting of the voltage per division and the center position voltage on the screen.

If the operator is changed, the Auto display range changes automatically in accordance with the operator that was changed. The mode remains set to Manual.

### Note

---

In the filter calculation (IIR filter), since the initial value is indeterminate, correct calculation is not possible immediately after the start of calculation. With a first-order filter the left end of the waveform is not shown, and with a second-order filter, both ends of the waveform are not shown.

---

## 9.6 Smoothing Waveforms (Using a Moving Average)

### Procedure

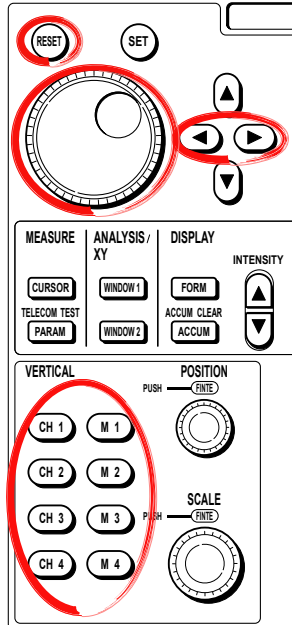

1. Press one of the **CH1** to **CH4** or **M1** to **M4** keys to select the channel.
2. Press the **Select** soft key and select **MATH**.

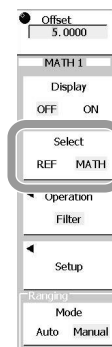

### Selecting the Operator

3. Press the **Operation** soft key.
4. Press the **Filter** soft key.

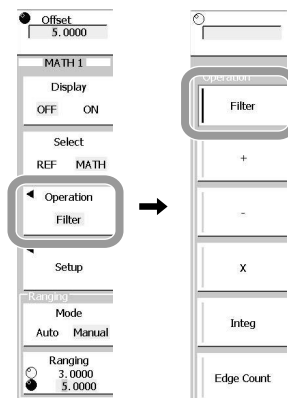



**Setting the Operation**

5. Press the **Setup** soft key.

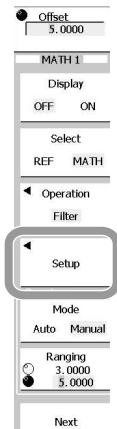

• **Selecting the Target Waveform**

6. Press the **Source** soft key. A menu used to select the waveform to be computed appears.

When CH1 to CH4 on the front panel are set, the waveform to be computed is fixed to the channel that is set. A menu used to select the waveform to be computed don't appears. Proceed to step 8.

7. Press the soft key corresponding to the target waveform.

To select REF1 to REF4, first switch to **REF1-REF4** by pressing the corresponding soft key.

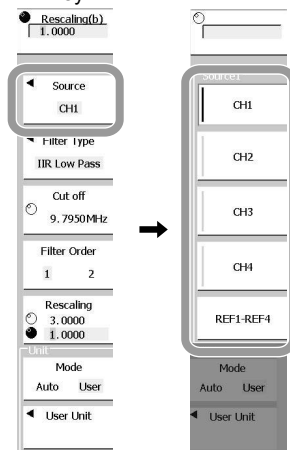

• **Setting the Filter Type**

8. Press the **Filter Type** soft key.
9. Press the **Moving Avg** soft key.

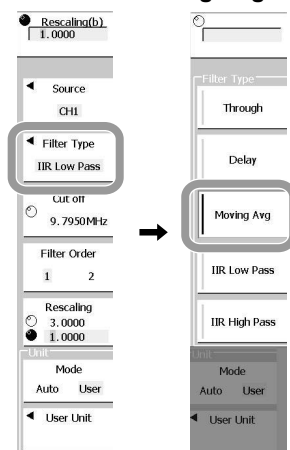

• **Setting Weighted Points**

10. Use the rotary knob to set the number of weighted points used to calculate the weighted moving average.

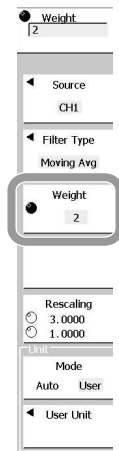

• **Setting Scaling for the Operation Results**

11. Press the **Rescaling** soft key.
12. Turn the **rotary knob** to set rescaling.  
Pressing RESET resets the values.  
You can use the arrow keys to move the digit that is currently being set.

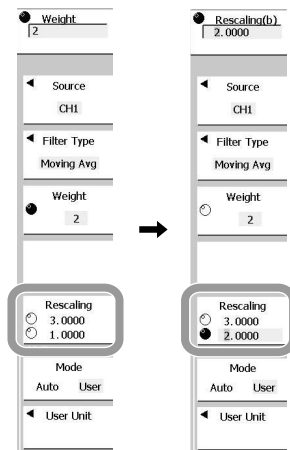

## 9.6 Smoothing Waveforms (Using a Moving Average)

### Setting the Unit

13. Press the **Mode** soft key to select Auto or User.  
If you select Auto, proceed to step 16.
14. Press the **User Unit** soft key.
15. See section 4.2. Enter the unit and press the **Enter** soft key.
16. Press **ESC**.

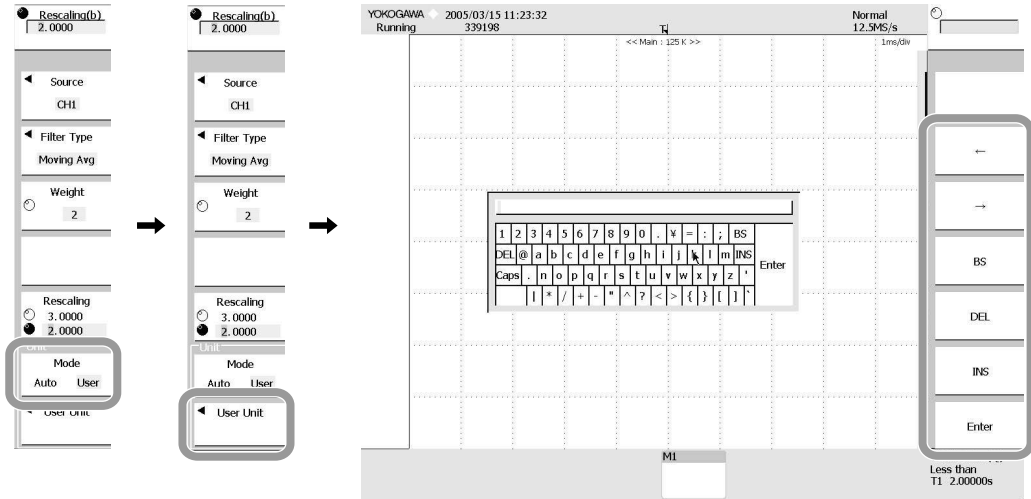

### Ranging (setting the display range)

17. Press the **Mode** soft key to select Auto or Manual.
18. If Manual is selected, press the **Ranging** soft key and use the rotary knob to set the voltage per division and the center position voltage.

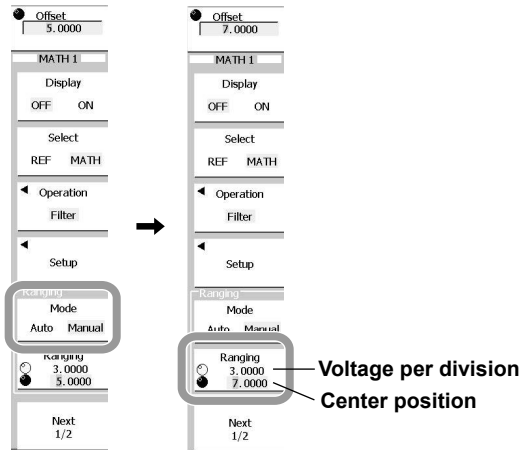

**Explanation****Moving Average (Smoothing)**

The averaging is carried out using the following formula.

$$X_n = \left( \sum_{i=n-N}^{n+N-1} X_i + \sum_{i=n-N+1}^{n+N} X_i \right) / (2N \times 2)$$

(When Weight is set to 2N)

**Weighted Points**

Sets the number of points to be smoothed.

A value ranging from 2 to 128(2<sup>7</sup>) can be set.

**Waveform to Be Computed**

Select from among CH1 to CH4, or REF1 to REF4. When CH1 to CH4 on the front panel are used for operation, the waveform to be computed is fixed to the channel that is being operated.

**Scaling Computed Results: Rescaling**

This sets scaling on computed results.

**Unit**

Auto: Uses the initial value.

Initial value: V, A, VV, AA, VA

User: A character string of up to four characters can be set.

**Ranging**

Set the waveform display range.

Auto: The waveform display range is automatically computed based on the V/div, operator, offset value, etc., of the target waveform.

Manual: The waveform display range is determined based on the setting of the voltage per division and the center position voltage on the screen.

If the operator is changed, the Auto display range changes automatically in accordance with the operator that was changed. The mode remains set to Manual.

## 9.7 Edge Count

This function can be used on products with firmware version 1.60 or later.

### Procedure

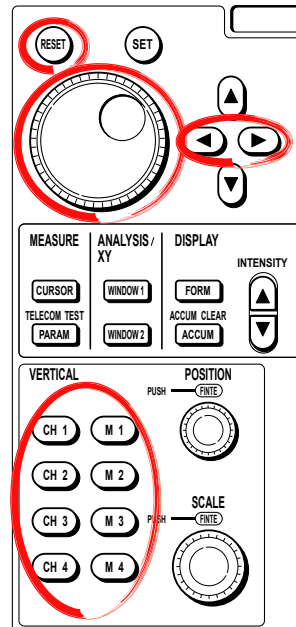

1. Press any of the **CH1** to **CH4** and **M1** to **M4** keys to select the channel to be configured.
2. Press the **Select** soft key to select MATH.

### Selecting the Operator

3. Press the **Operation** soft key to display the Operation menu.
4. Press the **Edge Count** soft key.

#### For CH1

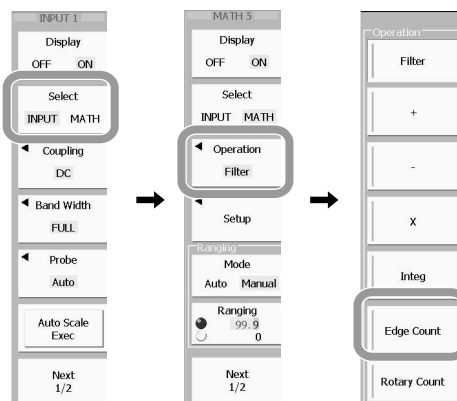

### Setting the Count Conditions

5. Press the **Setup** soft key.
6. Press the **Source** soft key. A menu used to select the waveform to be computed appears. Press the soft key corresponding to the target waveform.

To select REF1 to REF4, first switch to **REF1-REF4** by pressing the corresponding soft key.

When CH1 to CH4 on the front panel are set, the waveform to be computed is fixed to the channel that is set. A menu used to select the waveform to be computed don't appears.

7. Turn the **rotary knob** to set the threshold level for detecting edges.
8. Press the **Polarity** soft key to select  $\uparrow$  or  $\downarrow$ .
9. Turn the **rotary knob** to set the hysteresis.
10. Press the **Initial Point** soft key.
11. Turn the **rotary knob** to set the count start point. Or, press the **Jump to** soft key to show a preset menu, and set the count start point.

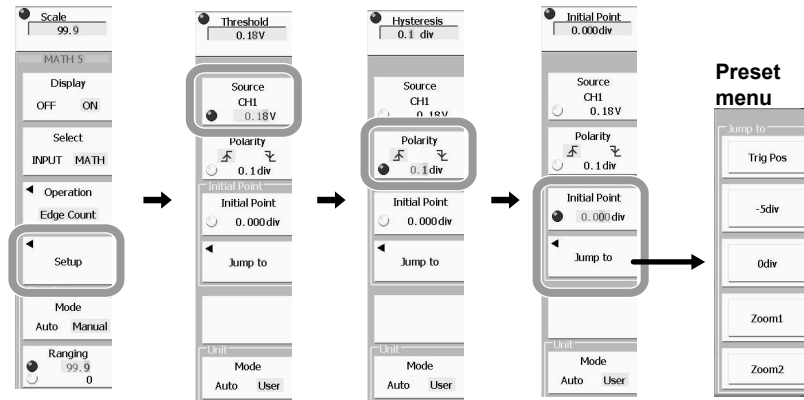

### Setting the Unit

12. Press the **Mode** soft key to select Auto or User.  
If Auto is selected, proceed to step 15.
13. Press the **User Unit** soft key.
14. Refer to section 4.2. Then, press the **Enter** soft key.
15. Press **ESC** to return to the previous screen.

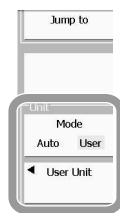

### Ranging (Setting the Display Range)

16. Press the **Mode** soft key to select Auto or Manual.
17. If Manual is selected, press the **Ranging** soft key and turn the **rotary knob** to set the number of counts per division and the count value at the center position.

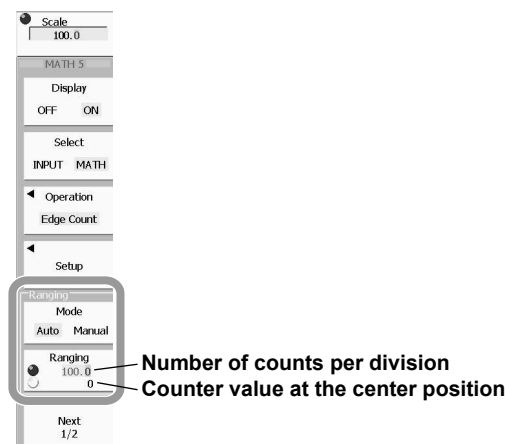

### Explanation

The waveform edge can be counted. This function can be used on products with firmware version 1.60 or later.

#### Setting the Count Conditions

- **Waveform to Be Computed (Source)**

Select CH1 to CH4 or REF1 to REF4. If you press CH1 to CH4 on the front panel, the selected channel becomes the waveform to be computed.

- **Detection Level**

When the waveform passes through the specified level, it is detected as an edge.

- **Polarity**

Select the slope of the waveform on which to detect the edge.

↗ : Detects edges when the waveform slope is rising.

↘ : Detects edges when the waveform slope is falling.

- **Hysteresis**

Sets a width to the detection level so that edges are not detected by small changes.

Selectable range: 0.0 divisions to 4.0 divisions

Resolution: 0.1 division

- **Setting the Count Start Point (Initial Point)**

Sets the start point for counting edges.

Selectable range: -5.00 divisions to 5.00 divisions

Resolution: 0.01 division

You can also set the following points (Jump to).

Trig Pos (trigger position), -5div, 0div, Zoom1 (center position of Zoom1), or Zoom2 (center position of Zoom2)

#### Unit

Auto: Uses the default value.

Default value: Blank

User: Set an arbitrary character string using up to 4 characters.

#### Ranging

Set the waveform display range.

Auto: Automatically determines the waveform display range from the V/div setting, operator, offset value, and so on of the source waveform.

Manual: Determines the waveform display range by setting the voltage per division and the voltage at the center of the display.

If you change the operator, the display range changes to the auto range corresponding to the new operator. The mode remains at Manual.

## 9.8 Rotary Count

This function can be used on products with firmware version 1.60 or later.

### Procedure

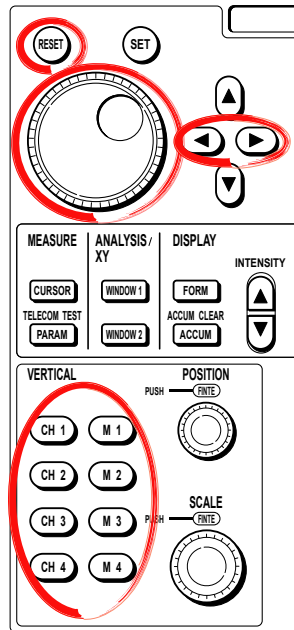

1. Press any of the **CH1** to **CH4** and **M1** to **M4** keys to select the channel to be configured.
2. Press the **Select** soft key to select MATH.

### Selecting the Operator

3. Press the **Operation** soft key to display the Operation menu.
4. Press the **Rotary Count** soft key.

#### For CH1

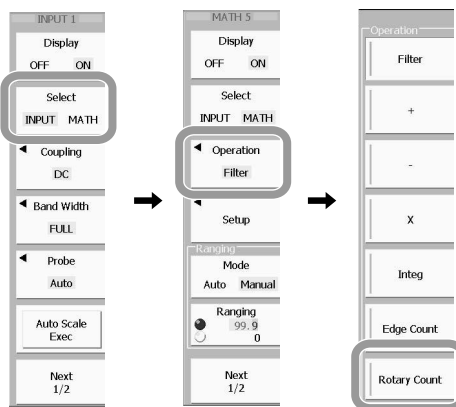



**Setting the Count Conditions**

5. Press the **Setup** soft key.
6. Press the **Source1** soft key. A menu used to select the waveform to be computed appears. Press the soft key corresponding to the target waveform.  
 To select REF1 to REF4, first switch to **REF1-REF4** by pressing the corresponding soft key.  
 When CH1 to CH4 on the front panel are set, the waveform to be computed is fixed to the channel that is set. A menu used to select the waveform to be computed don't appears.
7. Turn the **rotary knob** to set the determination level of phase A.
8. Press the **Source2** soft key twice to display the Source2 menu.
9. Press any of the **CH1** to **CH4** and **REF1-REF4** soft keys to select Source2.  
 To select REF1 to REF4, first switch to **REF1-REF4** by pressing the corresponding soft key.
10. Turn the **rotary knob** to set the determination level of phase B.
11. Press the **Initial Point** soft key.
12. Turn the **rotary knob** to set the count start point. Or, press the **Jump to** soft key to show a preset menu, and set the count start point.

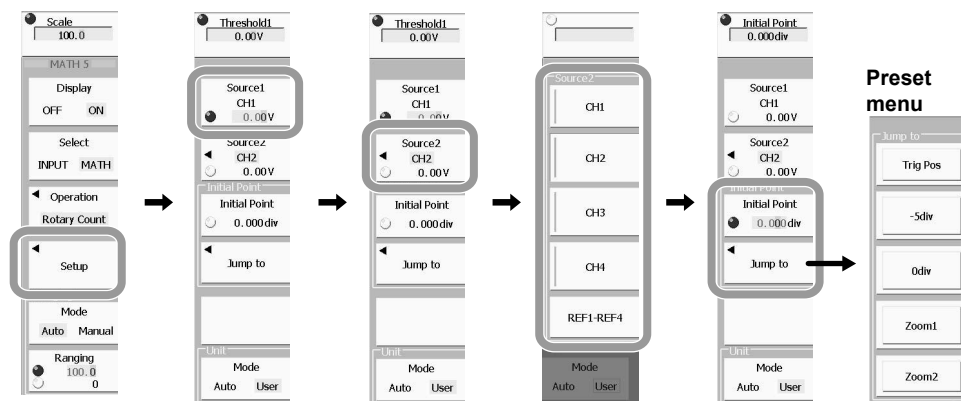

**Setting the Unit**

13. Press the **Mode** soft key to select Auto or User.  
 If Auto is selected, proceed to step 16.
14. Press the **User Unit** soft key.
15. Refer to section 4.2 in the *DL9000 User's Manual IM701310-01E*, and enter the unit. Then, press the **Enter** soft key.
16. Press **ESC** to return to the previous screen.

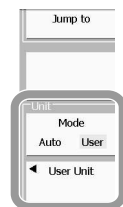

**Ranging (Setting the Display Range)**

17. Press the **Mode** soft key to select Auto or Manual.
18. If Manual is selected, press the **Ranging** soft key and turn the **rotary knob** to set the number of counts per division and the count value at the center position.

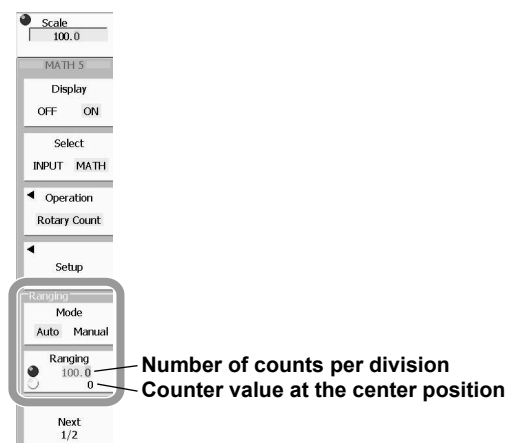

## Explanation

Rotary count can be used. The counter is increased or decreased according to the phase change of phase A and B. This function can be used on products with firmware version 1.60 or later.

### Setting the Count Conditions

- Waveform to be Computed of Phase A (Source1)**  
 Select CH1 to CH4 or REF1 to REF4. If you press CH1 to CH4 on the front panel, the selected channel becomes the waveform to be computed.
- Determination Level of Phase A**  
 The state in which the waveform of phase A exceeds the specified level is 1 and 0 otherwise.
- Waveform to be Computed of Phase B (Source2)**  
 Select CH1 to CH4 or REF1 to REF4.
- Determination Level of Phase B**  
 The state in which the waveform of phase B exceeds the specified level is 1 and 0 otherwise.
- Changes in the Phase of Phase A and Phase B**  
 The counter is increased or decreased according to the phase change (change in the 0 and 1 states) in phase A and phase B as shown below.

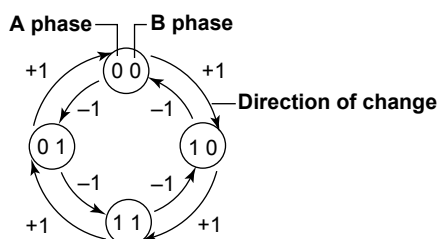

- **Setting the Count Start Point (Initial Point)**

Sets the start point of counting.

Selectable range: -5.00 divisions to 5.00 divisions

Resolution: 0.01 division

You can also set the following points (Jump to).

Trig Pos (trigger position), -5div, 0div, Zoom1 (center position of Zoom1), or Zoom2 (center position of Zoom2)

### **Unit**

Auto: Uses the default value.

Default value: Blank

User: Set an arbitrary character string using up to 4 characters.

### **Ranging**

Set the waveform display range.

Auto: Automatically determines the waveform display range from the V/div setting, operator, offset value, and so on of the source waveform.

Manual: Determines the waveform display range by setting the voltage per division and the voltage at the center of the display.

If you change the operator, the display range changes to the auto range corresponding to the new operator. The mode remains at Manual.

# 9.9 User-Defined Computation (Optional)

## Procedure

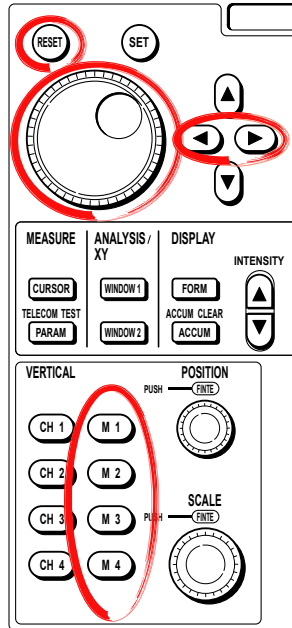

### Entering User-Defined Math Mode

1. Press a soft key from **M1** to **M4** for the computation channel to set.
2. Press the **Select** soft key to select MATH.

### Selecting the Operator

3. Press the **Operation** soft key.
4. Press the **Next 1/2** soft key.
5. Press the **User Define** soft key.

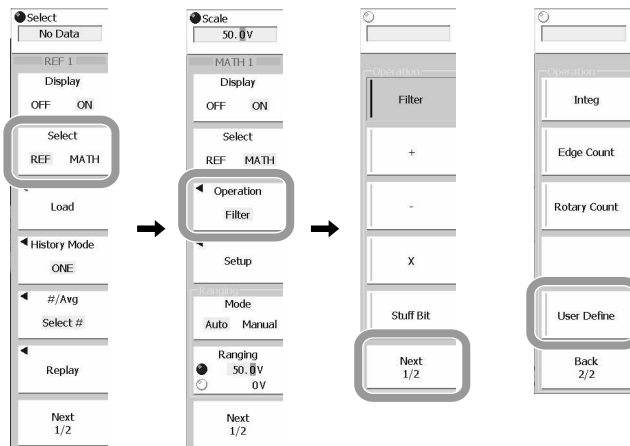

## 9.9 User-Defined Computation (Optional)

### Setting Up Computation

6. Press the **Setup** soft key.
7. Press the **Edit** soft key. The equation definition dialog box opens.
8. Enter an equation (of 128 characters or fewer) following the information in section 4.2, and then press the **Enter** soft key.

To enter a waveform parameter, select Measure Item in the dialog box to display the waveform parameter selection dialog box, and then select the area, channel, and parameter.

### Note

Waveform parameters are displayed in the following format.

- "P." is added to the front of the selected waveform parameter.
- The target channel and area of the waveform parameter are shown in parentheses ( ). If the target area is Area 1, the target area display is omitted.

P.Max(C1):CH1, maximum value of Area 1

P.Max(C1, A2):CH1, maximum value of Area 2

9. Press **ESC** to return to the previous screen.

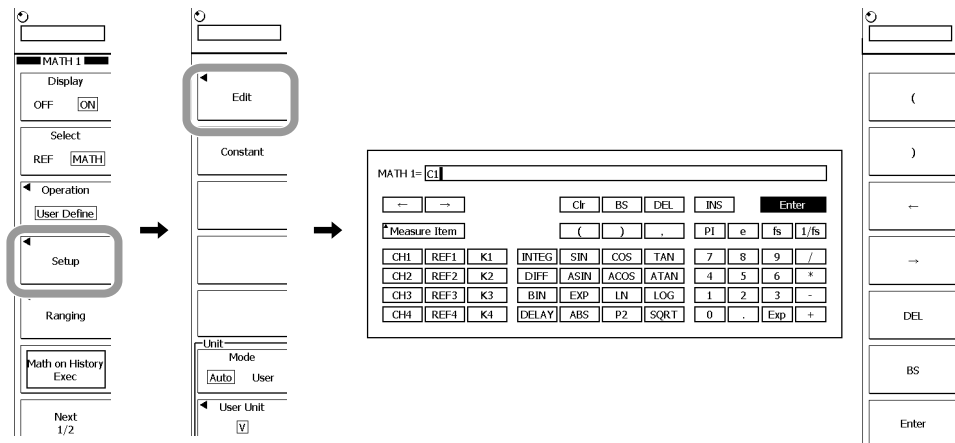

### Measure Item Setting Screen

V1, V2, and ΔT can be used on products with firmware version 3.6 or later.

<input type="checkbox"/> Max	<input type="checkbox"/> Min	<input type="checkbox"/> High	<input type="checkbox"/> Low
<input type="checkbox"/> P-P	<input type="checkbox"/> Hi-Low	<input type="checkbox"/> +Over	<input type="checkbox"/> -Over
<input type="checkbox"/> Rms	<input type="checkbox"/> Mean	<input type="checkbox"/> Sdev	<input type="checkbox"/> IntegTY
<input type="checkbox"/> C.Rms	<input type="checkbox"/> C.Mean	<input type="checkbox"/> C.Sdev	<input type="checkbox"/> C.IntegTY
<input type="checkbox"/> V1	<input type="checkbox"/> V2		
<input type="checkbox"/> Freq	<input type="checkbox"/> 1/Freq	<input type="checkbox"/> Count	<input type="checkbox"/> Burst
<input type="checkbox"/> +Width	<input type="checkbox"/> -Width	<input type="checkbox"/> Period	<input type="checkbox"/> Duty
<input type="checkbox"/> Rise	<input type="checkbox"/> Fall		
<input type="checkbox"/> ΔT			

Cancel   Enter

Enter the item

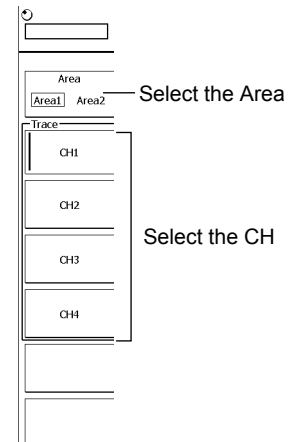

**Setting Constants**

10. Press the **Constant** soft key.
11. Press a soft key from **K1** to **K4** to assign the jog shuttle for the constant you wish to set.
12. Turn the **rotary knob** to set the constant.
13. Press **ESC** to return to the previous screen.

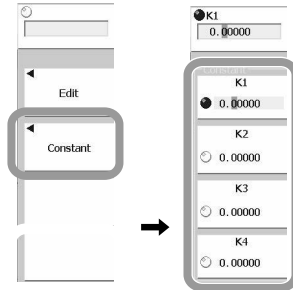

**Setting the Unit**

14. Press the **Mode** soft key to select Auto or User.  
If you select Auto, units entered in steps 15 through 17 are not used. Skip to step 18.
15. Press the **User Unit** soft key.
16. Enter a unit following the information in section 4.2, and then press the **Enter** soft key.
17. Press **ESC** to return to the previous screen.

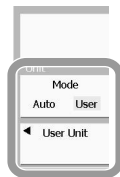

**Ranging (Setting the Display Range)**

18. Press the **Ranging** soft key.
19. If you wish to set the display range automatically, press the **Auto Ranging Exec** soft key to execute ranging.  
To set the range manually, use the **Ranging** soft key and the **rotary knob** to set the value per div and center position.

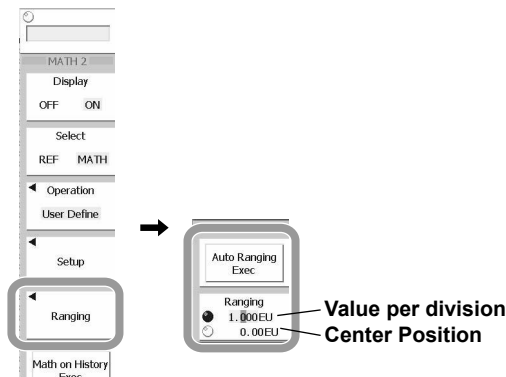

20. Press **ESC** to return to the previous screen.

**Performing Computation on All History Waveforms**

21. To perform specified computations on all history waveforms, press the **Math on History Exec** soft key. The computation is executed, and the Math on History Exec display changes to Abort.

To cancel computation, press the **Abort** soft key. The computation is Aborted, and the Abort display changes to Math on History Exec.

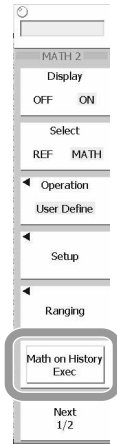

**Explanation**

This section describes the setting operations in User-Defined Math (option) mode. For the settings in normal computation mode, see sections 9.1 through 9.8.

**Waveforms That Can Be Used in Expressions**

The following waveform data can be used in equations.

Menu Symbols	Description
CH1–CH4	Channel waveforms. Displayed as C1 through C4 in equations
REF1–REF4	Reference waveforms. Displayed as R1 through R4 in equations

**Operator**

You can define equations by combining the following functions.

Menu Symbols	Setting Example	Description
+, -, *, /	CH1+CH2-C3	Arithmetic operations for the input value
ABS	ABS(C1)	Absolute value of the input value
SQRT	SQRT(C2)	Square root of the input value
LOG	LOG(C1)	Logarithm of the input value
LN	LN(C1)	Natural logarithm of the input value
EXP	EXP(C1)	Exponent of the input value
P2	P2(C1)	Square of the input value
-	-(C1)	Inverts the input values around the center level
SIN	SIN(C1)	Sine of the input value
ASIN	ASIN(C1)	Arcsine of the input value
COS	COS(C1)	Cosine of the input value
ACOS	ACOS(C1)	Arccosine of the input value
TAN	TAN(C1)	Tangent of the input value
ATAN	ATAN(C1)	Arctangent of the input value
DIFF	DIFF(C1)	Differential of the input value
INTEG	INTEG(C1)	Integral of the input value
DELAY	DELAY(C1,K1)	Phase shift of the input value
BIN	BIN(CH1, K1, K2)	Binary representation of the input value

**Constants**

Menu Symbols	Description
K1–K4	Specified constants The setting range is -10E+30 to 10E+30 M1 through M4 can be set to constants K1 through K4.
0–9	Can be entered with the numeric key pad
Exp	Exponent input Used in conjunction with the keyboard when entering exponents in equations (1E+3=1000, 2.5E-3=0.0025) Displayed with an E to differentiate it from the EXP operator in equations
PI	$\pi$
e	Napier's constant Base of the natural logarithm (e=2.718...) Displayed with an "eul" in equations to differentiate it from the E for exponents.
fs	Sample rate The sample rate value on the instrument when performing computations. Linked with (changes with) changes in the T/div value or record length.
Measure Item	Specified waveform parameter

**Waveform Parameters**

Computations can be made using measured values of waveform parameters. Power supply analysis parameters can also be used if the power supply analysis function (/G4 option) is installed.

- Displayed waveform parameters are preceded with a P. in equations.
- Waveform parameter values cannot be acquired when display of the waveform under test is turned OFF.
- If the area is omitted, Area 1 is used.

**Examples of Entering Equations****Example of input other than DIFF, INTEG, DELAY, or BIN**

Equations can be defined by combining waveforms and constants with operators.

SIN(PI)	Using a constant with an operator
COS(C1)	Using a waveform with an operator
ABS(C1+C2*2)	Waveform and constant expressions referenced in an operator
SQRT(ABS(C1+C2*2))	Referencing an operator within another operator

**Entering Differentials and Integrals**

Waveforms or expressions including waveforms can be referenced by the DIFF and INTEG operators.

DIFF(5)	Invalid because 5 is a constant
INTEG(K1+10)	Invalid because K1+10 includes a constant
DIFF(C1/3)	C1/3 part
INTEG(INTEG(C3))	Double integral of C3
DIFF(DIFFC4)	Double differential of C4

**Entering DELAY (Phase Shift)**

DELAY is set in the format DELAY (waveform, constant).

Waveform: The waveform to be phase-shifted. Entered using a monomial of 1 waveform

Constant: The amount of shifting. Entered using a constant or a constant expression.

DELAY(C1,C2)	Invalid because the phase shift amount is a constant or a constant expression
DELAY(C1+C2,5)	Invalid because the phase shifted waveform is not a monomial of 1 waveform
DELAY(C1,5E-3)	Phase-shifts waveform C1 by 0.005
DELAY(C2,P.Period(C2)*2)	Phase-shifts waveform C2 by "2 periods of waveform C2"



## 9.9 User-Defined Computation (Optional)

---

### Entering BIN (Binarization)

BIN is set in the format BIN(waveform, constant1, constant2).

Waveform: The waveform to be binarized. Entered using a constant or a constant expression.

Constant1: Specifies the threshold level (Level). Entered using a constant or a constant expression.

Constant2: Specifies the hysteresis (Hys). Entered using a constant or a constant expression.

BIN(5,10,2)	Invalid because the target waveform is not a waveform
BIN(C1,C2,C3)	Invalid because the Level and Hys are not constants or constant expressions
BIN(C1+C2)	Binarizes C1 + C2 with Level = 0 and Hys = 0
BIN(C2,P,Mean(C2))	Binarizes C2 with Level = "mean of waveform C2" and Hys = 0
BIN(C1,1,P.PP(C1)/10)	Binarizes C1 with Level = 1 and Hys = "1/10 of the P-P value of waveform C1"

### Computation on All History Waveforms

With waveform acquisition stopped, press the Math on History Exec soft key, and perform user-defined math on all history waveforms.

#### **Note**

---

- User-defined computation cannot be performed on all history waveforms while waveforms are being acquired.
  - The computation-in-progress icon appears at the lower left of the screen, and a progress bar is displayed in the center of the screen while the user-defined computation on all history waveforms is in progress. All operations other than the Abort soft key are disabled.
  - If you set the trigger mode to N Single and start the waveform acquisition, user-defined computation is performed only on the latest waveform after the acquisition is stopped. To perform user-defined computation on all history waveforms, carry out the procedure given in "Executing the Computation on All History Waveforms."
  - If you change a setting that affects the user-defined computation result, recomputation is performed only on the selected history waveform.
  - The Average display of HISTORY or PARAM of History Statistics appears only if all history waveforms exist. If the Average display of History or PARAM of History Statistics is not performed, carry out the procedure given in "Executing the Computation on All History Waveforms."
- 

### Unit

Auto: Use the initial value.  
Initial value: EU

User: Can be set with an arbitrary string of up to 4 characters.

### Ranging

Sets the waveform display range.

The waveform display range is determined by setting the value per div and the screen center position.

Pressing the Auto Ranging Exec soft key causes the DL9000 to determine the optimal waveform display range from the maximum and minimum values of the relevant MATH waveform and apply it to the settings.

# 10.1 Making Cursor Measurements

## Procedure

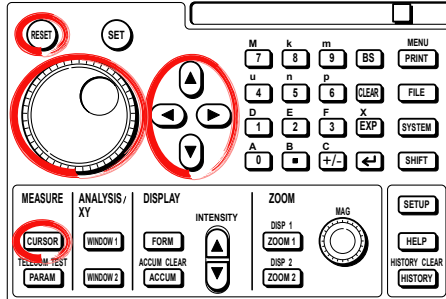

1. Press **CURSOR**.  
The cursors appear.

### Selecting the Cursor Type

2. Press the **Type** soft key. The cursor selection menu appears.
3. Press the soft key corresponding to the desired cursor type.

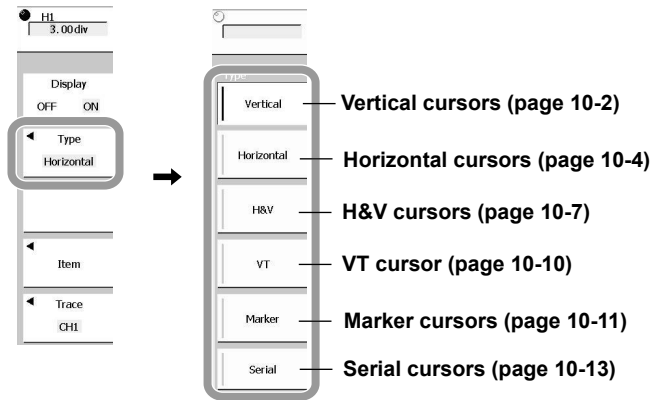

## Vertical Cursors

### Selecting the Measurement Item

4. Press the **Item** soft key.
- **Selecting the Basic Measurement Item**
    5. Press the **Basic** soft key.
    6. With the **rotary knob**, select the item for which you want to display the result, and press SET to add a check mark.  
With [ALL ON] selected, press SET to add check marks to all items.  
With [ALL OFF] selected, press SET to remove check marks from all items.
  - **Setting Equations (To Calculate from Cursor Measurements)**
    7. Press the **Calc** soft key.
    8. With the **rotary knob** select the calculation number, and press **SET** to add a check mark.
    9. With the **rotary knob**, move the cursor to the equation whose calculation number is checked, and press **SET**. A screen for entering the equation appears.
    10. With the **numeric keypad**, **rotary knob**, and **SET** on the panel, enter the calculation equation. When equation entry is completed, press ENTER to confirm the equation.
    11. Press **ESC**. This returns to the screen.

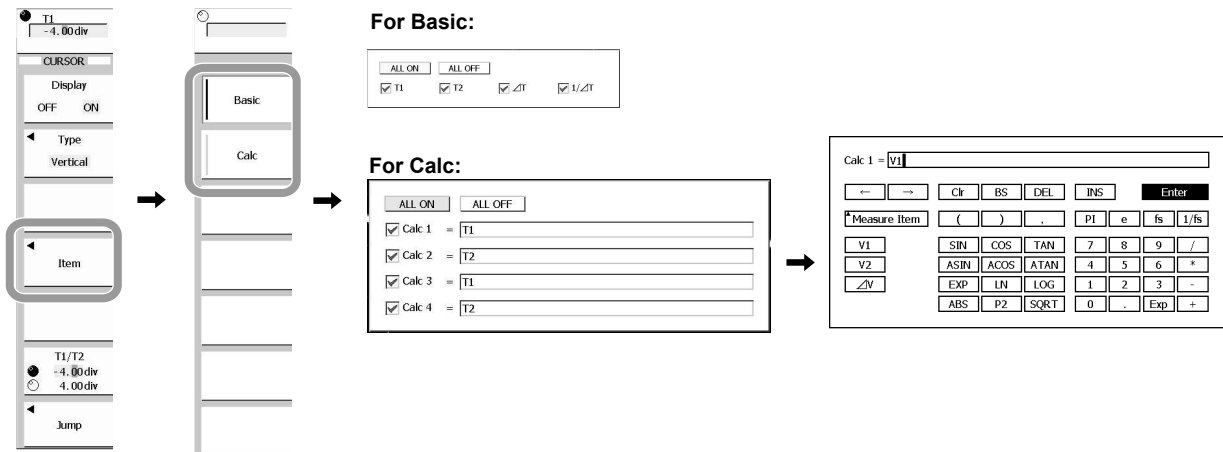

### Moving the Cursors

12. Press the **T1/T2** soft key, to assign the rotary knob to T1.
13. With the **rotary knob** or **up and down arrow keys**, move T1.  
Press **RESET** to reset the value.  
With the left and right arrow keys you can change the digit to be set.
14. Move T2 similarly.

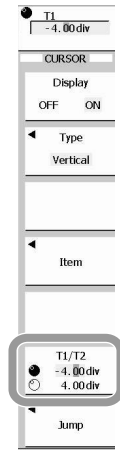

### Jump Setting

15. Press the **Jump** soft key. A menu appears for selecting the zoom window to jump to.
16. Press the **To Zoom1** or **To Zoom2** soft key to select the zoom window to jump to.

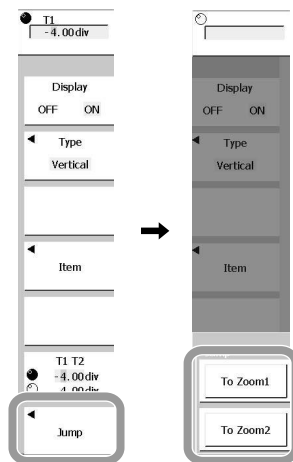

## Horizontal Cursors

### Selecting the Measurement Item

4. Press the **Item** soft key.
- **Selecting the Basic Measurement Item**
    5. Press the **Basic** soft key.
    6. With the **rotary knob**, select the item for which you want to display the result, and press **SET** to add a check mark.
      - With **[ALL ON]** selected, press **SET** to add check marks to all items.
      - With **[ALL OFF]** selected, press **SET** to remove check marks from all items.
  - **Setting Equations (To Calculate from Cursor Measurements)**
    7. Press the **Calc** soft key.
    8. With the **rotary knob** select the calculation number, and press **SET** to add a check mark.
    9. With the **rotary knob**, move the cursor to the equation whose calculation number is checked, and press **SET**. A screen for entering the equation appears.
    10. With the **numeric keypad**, **rotary knob**, and **SET** on the panel, enter the calculation equation. When equation entry is completed, press **ENTER** to confirm the equation.
    11. Press **ESC**. This returns to the screen.

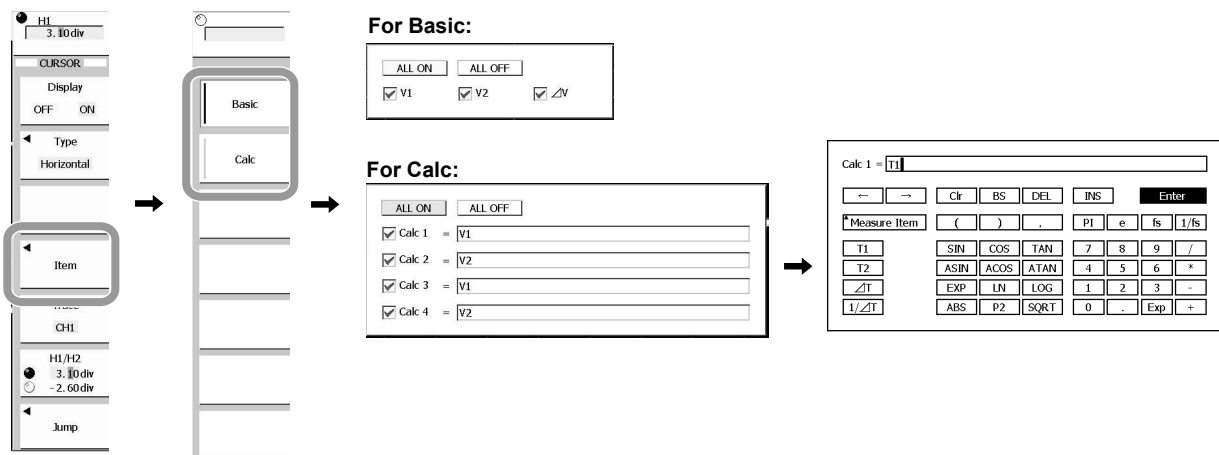

### Selecting the Target Waveform

12. Press the **Trace** soft key. The waveform selection menu appears.
13. Press the soft key for the waveform you want to select.

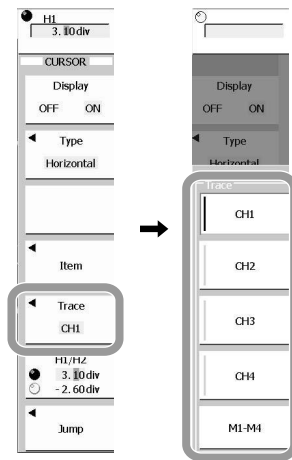

### Moving the Cursors

14. Press the **H1/H2** soft key, to assign the rotary knob to H1.
15. With the **rotary knob** or **up and down arrow keys**, move H1.  
Press **RESET** to reset the value.  
With the left and right arrow keys you can change the digit to be set.
16. Move H2 similarly.

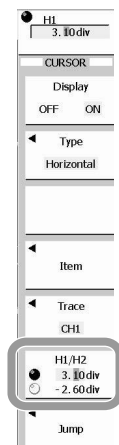

## 10.1 Making Cursor Measurements

---

### Jump Setting

17. Press the **Jump** soft key. A menu appears for selecting the zoom window to jump to.
18. Press the **To Zoom1** or **To Zoom2** soft key to select the zoom window to jump to.

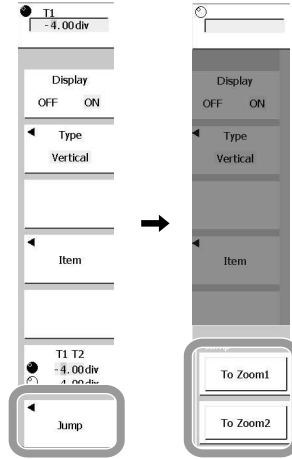

## H&V Cursors

### Selecting the Measurement Item

4. Press the **Item** soft key.

#### • Selecting the Basic Measurement Item

5. Press the **Basic** soft key.

6. With the **rotary knob**, select the item for which you want to display the result, and press SET to add a check mark.

With [ALL ON] selected, press SET to add check marks to all items.

With [ALL OFF] selected, press SET to remove check marks from all items.

#### • Setting Equations (To Calculate from Cursor Measurements)

7. Press the **Calc** soft key.

8. With the **rotary knob** select the calculation number, and press **SET** to add a check mark. You can set a calculation equation using the Calc1 and Calc2 voltage values or a calculation formula using the Calc3 and Calc4 times.

9. With the **rotary knob**, move the cursor to the equation whose calculation number is checked, and press **SET**. A screen for entering the equation appears.

10. With the **numeric keypad**, **rotary knob**, and **SET** on the panel, enter the calculation equation. When equation entry is completed, press ENTER to confirm the equation.

11. Press **ESC**. This returns to the screen.

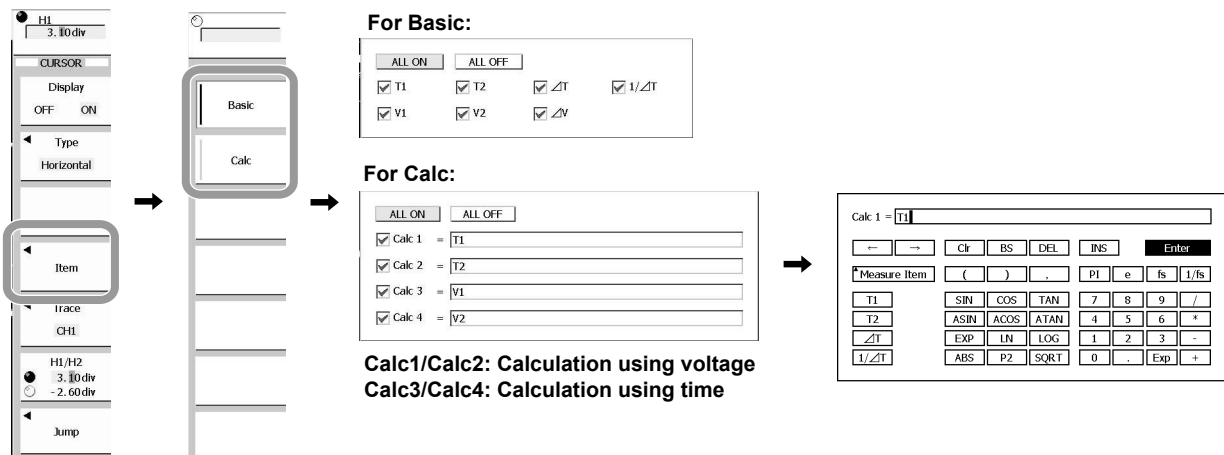



## 10.1 Making Cursor Measurements

### Selecting the Target Waveform

12. Press the **Trace** soft key. The waveform selection menu appears.
13. Press the soft key for the waveform you want to select.

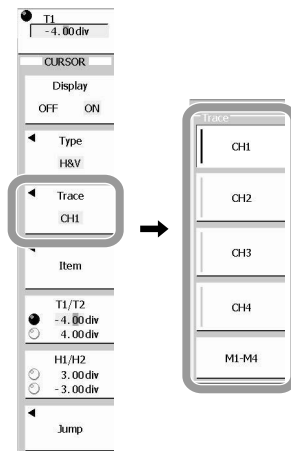

### Moving the Cursors

#### • Moving the Horizontal Cursors

14. Press the **T1/T2** soft key, to assign the rotary knob to T1.
15. With the **rotary knob** or **up and down arrow keys**, move T1.  
Press **RESET** to reset the value.  
With the left and right arrow keys you can change the digit to be set.
16. Move T2 similarly.

#### • Moving the Vertical Cursors

17. Press the **H1/H2** soft key, to assign the rotary knob to H1.
18. With the **rotary knob** or **up and down arrow keys**, move H1.  
Press **RESET** to reset the value.  
With the left and right arrow keys you can change the digit to be set.
19. Move H2 similarly.

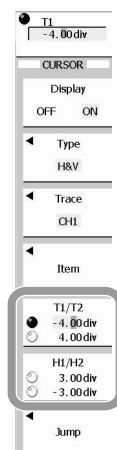

**Jump Setting**

20. Press the **Jump** soft key. A menu appears for selecting the zoom window to jump to.
21. Press the **To Zoom1** or **To Zoom2** soft key to select the zoom window to jump to.

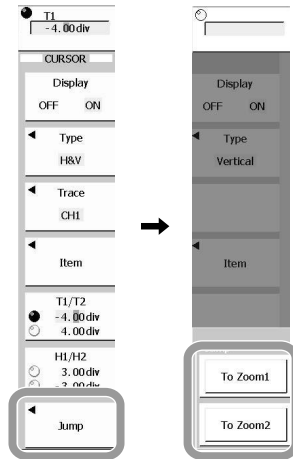

VT Cursor

Selecting the Measurement Item

4. Press the **Item** soft key.
- **Selecting the Basic Measurement Item**
    5. Press the **Basic** soft key.
    6. With the **rotary knob**, select the item for which you want to display the result, and press SET to add a check mark.  
With [ALL ON] selected, press SET to add check marks to all items.  
With [ALL OFF] selected, press SET to remove check marks from all items.
  - **Setting Equations (To Calculate from Cursor Measurements)**
    7. Press the **Calc** soft key.
    8. With the **rotary knob** select the calculation number, and press SET to add a check mark.
    9. With the **rotary knob**, move the cursor to the equation whose calculation number is checked, and press SET. A screen for entering the equation appears.
    10. With the **numeric keypad**, **rotary knob**, and **SET** on the panel, enter the calculation equation. When equation entry is completed, press ENTER to confirm the equation.
    11. Press **ESC**. This returns to the screen.

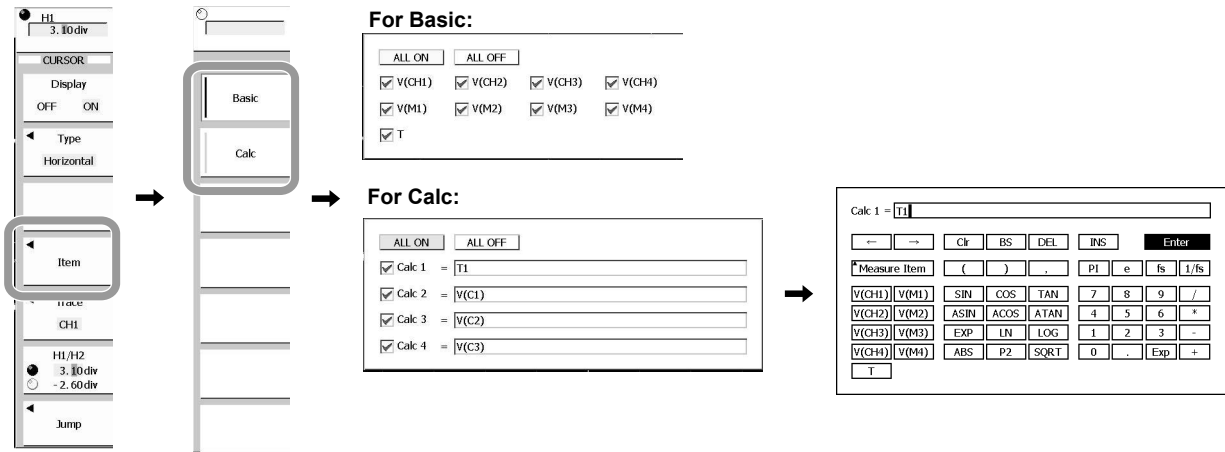

Moving the Cursor

12. Move the cursor with the **rotary knob** or **up and down arrow keys**.

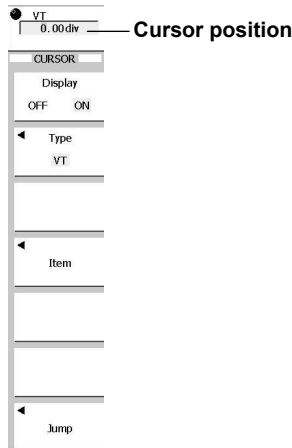

## Marker Cursors

### Selecting the Marker Form

(This function can be used on products with firmware version 3.20 or later.)

- Press the **Marker Form** soft key to select Mark or Line.

### Selecting the Measurement Item

- Press the **Item** soft key.

- Selecting the Basic Measurement Item**

- Measurement items can be selected for each of the four markers, **MC1** to **MC4**. Press the soft key for the marker you want to use.
- With the **rotary knob**, select the item for which you want to display the result, and press SET to add a check mark.  
With [ALL ON] selected, press SET to add check marks to all items.  
With [ALL OFF] selected, press SET to remove check marks from all items.

- Setting Equations (To Calculate from Cursor Measurements)**

- Press the **Calc** soft key.
- With the **rotary knob** select the calculation number, and press **SET** to add a check mark.
- With the **rotary knob**, move the cursor to the equation whose calculation number is checked, and press **SET**. A screen for entering the equation appears.
- With the **numeric keypad**, **rotary knob**, and **SET** on the panel, enter the calculation equation. When equation entry is completed, press ENTER to confirm the equation.
- Press **ESC**. This returns to the screen.

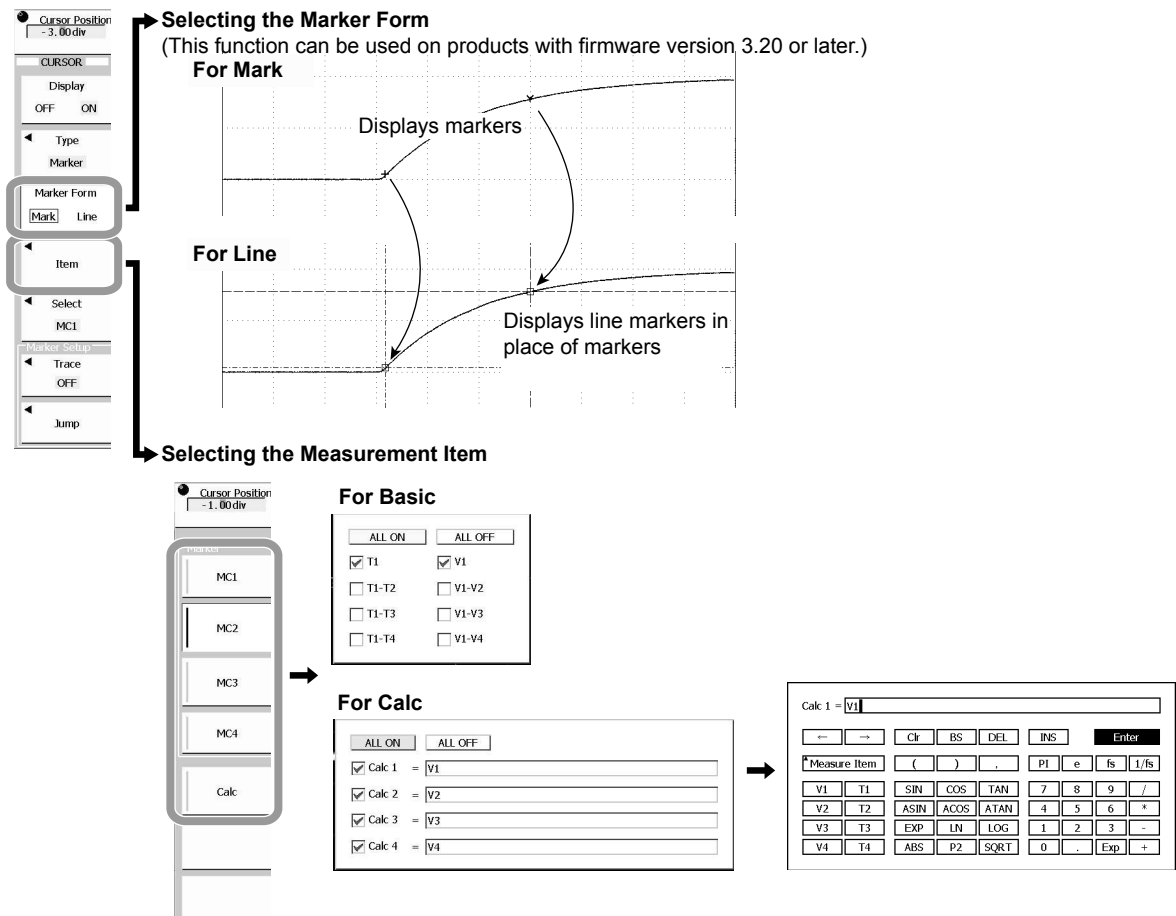

## 10.1 Making Cursor Measurements

### Selecting the Marker

13. Press the **Select** soft key.
14. You can select from the four markers, MC1 to MC4. Press the soft key for the marker you want to use.

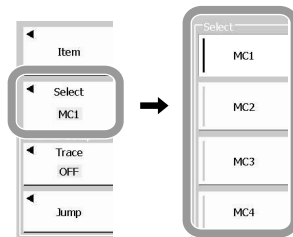

### Selecting the Target Waveform

15. Press the **Trace** soft key. The waveform selection menu appears.
16. Press the soft key for the waveform for which you want to use the marker.

### Moving the marker

17. Move the marker with the **rotary knob** or **up and down arrow keys**.  
Press RESET to reset the value.  
With the left and right arrow keys you can change the digit to be set.

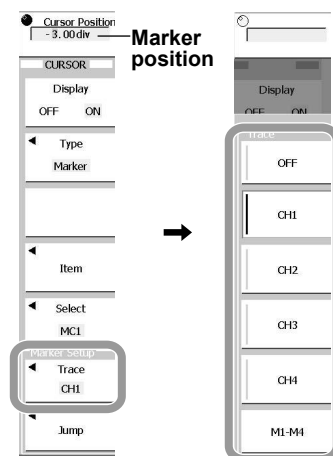

### Jump Setting

18. Press the **Jump** soft key. A menu appears for selecting the zoom window to jump to.
19. Press the **To Zoom1** or **To Zoom2** soft key to select the zoom window to jump to.

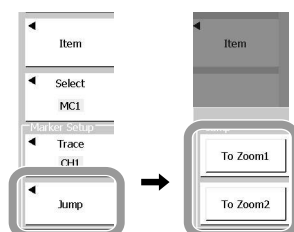

## Serial Cursors

### Selecting and Setting Serial Cursors

4. Press the **Select** soft key, to select SC1 or SC2.  
You can select SC1 or SC2 as the serial cursor.
5. Press the **Setup** soft key. The Setup menu appears.  
On products with firmware version 3.6 or later, press the Active soft key here to select H or L. You cannot make the selection in step 8 below.

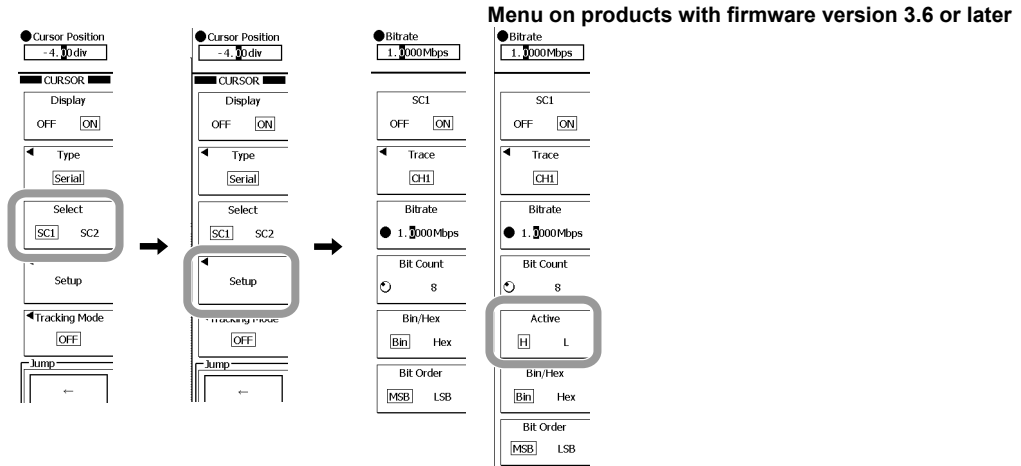

- **Selecting the Target Waveform**

6. Press the **Trace** soft key.
7. Press the soft key for the waveform for the serial cursor.
8. Press the **Active** soft key, to select H or L.
9. Press the **Level/Hys** soft key, to switch the rotary knob to Level.
10. Turn the **rotary knob** to set the level.  
Press RESET to reset the value.  
With the left and right arrow keys you can change the digit to be set.
11. Press the **Level/Hys** soft key, to assign the rotary knob to Hys.
12. Turn the **rotary knob**, to set the hysteresis.  
Press RESET to reset the value.  
With the left and right arrow keys you can change the digit to be set.
13. Press **ESC**. This returns to the setup menu.

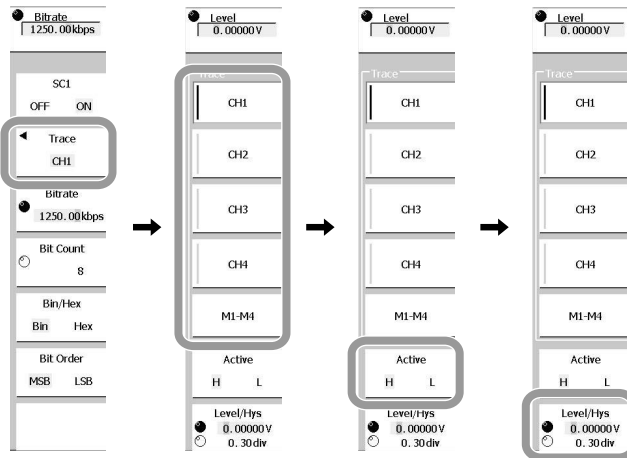

## 10.1 Making Cursor Measurements

- **Setting the Bitrate**

14. Press the **Bitrate** soft key.
15. Turn the **rotary knob**, to set the bitrate.  
Press RESET to reset the value.  
With the left and right arrow keys you can change the digit to be set.

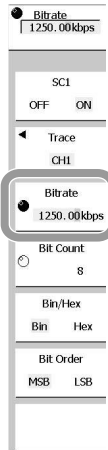

- **Setting the Bit Count**

16. Press the **Bit Count** soft key.
17. Turn the **rotary knob**, to set the bit count.

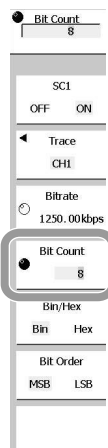

- **Selecting the Notation**

18. Press the **Bin/Hex** soft key, to select Bin or Hex.

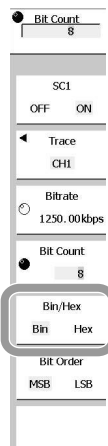

• **Specifying the Bit Order**

19. Press the **Bit Order** soft key, to select MSB or LSB.
20. Press **ESC**. This returns to the serial cursor menu.

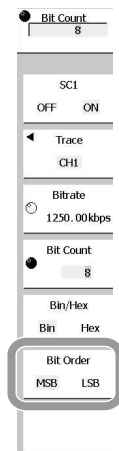

**Selecting the Tracking Mode**

21. Press the **Tracking Mode** soft key. A menu appears for selecting the tracking mode.
22. Press the **OFF**, **Zoom1** or **Zoom2** soft key to select the tracking mode.

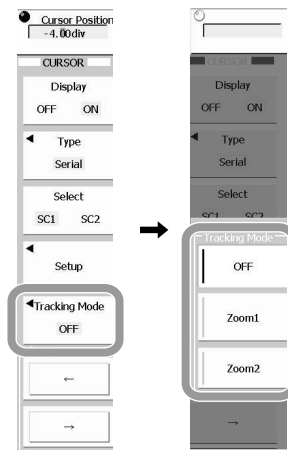

**Moving the Cursor**

23. Move the cursor with the **rotary knob** or **up and down arrow keys**.

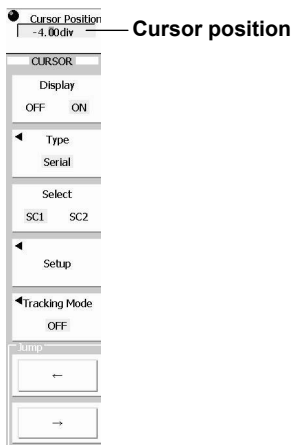



### Explanation

#### Limitations

It is not possible to measure the following waveforms.

- Snapshot waveforms
- Accumulated waveforms other than the most recent

#### Cursors and Measurement Items

- **Vertical (V) cursors**

Measure the position of the cursor on the X-axis. You can select the order of data values.

T1: X-axis value of the T1 cursor

T2: X-axis value of the T2 cursor

$\Delta T$ : X-axis value difference between the T1 and T2 cursors

$1/\Delta T$ : Reciprocal of the X-axis value difference between the T1 and T2 cursors

- **Horizontal (H) cursors**

Measure the position of the cursor on the Y-axis.

V1: Y-axis value of V1

V2: Y-axis value of V2

$\Delta V$ : Y-axis value difference between V1 and V2

- **Horizontal and Vertical Cursors: H&V**

Measure the value on the X-axis at the cursor position, and the value on the Y-axis at the cursor position.

X-axis

T1: X-axis value of the T1 cursor

T2: X-axis value of the T2 cursor

$\Delta T$ : X-axis value difference between the T1 and T2 cursors

$1/\Delta T$ : Reciprocal of the X-axis value difference between the T1 and T2 cursors

Y-axis

V1: Y-axis value of V1

V2: Y-axis value of V2

$\Delta V$ : Y-axis value difference between V1 and V2

- **Vertical time (VT) cursor**

Measures the time from the trigger position to the VT cursor, and the value of the waveform data selected by the VT cursor.

V(CH1): Y-axis value of CH1

V(CH2): Y-axis value of CH2

V(CH3): Y-axis value of CH3

V(CH4): Y-axis value of CH4

V(M1): Y-axis value of M1

V(M2): Y-axis value of M2

V(M3): Y-axis value of M3

V(M4): Y-axis value of M4

T: X-axis value

- **Marker Cursors**

By moving the cursors over the waveform data, you can measure data values. MC1 (Marker 1) to MC4 (Marker 4) can be set on different waveforms.

T1: MC1 X-axis (horizontal axis) value  
 T1-T2: X-axis value difference between MC1 and MC2  
 T1-T3: X-axis value difference between MC1 and MC3  
 T1-T4: X-axis value difference between MC1 and MC4  
 V1: MC1 Y-axis (vertical axis) values  
 V1-V2: Y-axis value difference between MC1 and MC2  
 V1-V3: Y-axis value difference between MC1 and MC3  
 V1-V4: Y-axis value difference between MC1 and MC4

- **Serial cursors**

Searches the waveform serial pattern (1s and 0s) at the specified bit rate from the serial cursor position. The search range is the display range (10 divisions). You can select the threshold level used to determine 1 and 0 and assign high or low with respect to the threshold level to 1. There are two serial cursors: SC1 and SC2. The two cursors cannot be displayed simultaneously, but the serial patterns can be.

### Movement Range of Cursors

- **H cursor**

With the center of the waveform area as 0 div, the range from -4 to +4 div can be set. The setting step is 0.01 div.

- **V cursors, marker cursors, VT cursor, Serial cursors**

With the center of the waveform area as 0 div, the range from -5 to +5 div can be set. The setting step is 0.01 div. When the zoom window is displayed, when the cursor enters the zoom window, the resolution becomes 0.01 div of the zoom window.

### Serial Cursor Display Format

When measuring with the serial cursors, you can set the following items.

- **Selecting the Notation for Cursor Measurement Values: Bin/Hex**

You can select the notation system used to display measured values.

Bin: Show in binary

Hex: Show in hexadecimal

- **Read Direction of Bit Data: Bit Order**

You can select the read direction of the bits according to the signal flow.

MSB First: Select this when the I/O data signal is flowing MSB first.

LSB First: Select this when the I/O data signal is flowing LSB first.

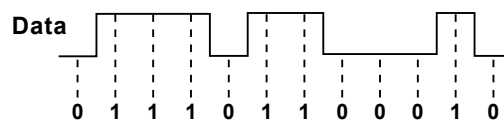

When set to MSB First: 762

When set to LSB First: 46E

- **Handling of Non-displayed Bits**

- In binary notation, an X is displayed for the bit.
- In hexadecimal notation, the value is displayed as though the bit does not exist.

## 10.1 Making Cursor Measurements

---

### Serial Cursor Tracking Mode

Set the handling when the cursor goes outside the zoom range.

OFF: If the cursor goes outside the zoom range, the zoom window does not track it.

Zoom1/Zoom2: If the cursor goes outside the Zoom1 or Zoom2 zoom range, then Zoom1 or Zoom2 scrolls so that the center position is at the cursor position.

### Cursor Jump

You can jump the cursor to the center of the zoom waveform area. The procedure for jumping is as follows.

- **Vertical cursors, horizontal cursors, H&V cursors, VT cursors, marker cursors**
  - To Zoom1: Make the selected cursor jump to the Z1 window.
  - To Zoom2: Make the selected cursor jump to the Z2 window.
- **Serial cursors**
  - ←/→: Jump by the set bit length in the specified direction

### Notes on Cursor Measurement

- Measurement values on the time axis are with respect to the trigger position.
- If there is data that cannot be measured, the measurement value is shown as "\*\*\*\*".
- When the Main and ZOOM1 or ZOOM2 display record length is less than 10 k words (but not 4 k or 5 k), and when Dot Connect is not OFF, the display is interpolated between the sampled data. Therefore, there may be no sampled data at the position of the vertical cursor.
- For the serial cursors, if the sample rate (S/s) divided by the bitrate (bit/s) exceeds 1,000,000, then all bits of the measurement result appear as X.

## 10.2 Automated Measurement of Waveform Parameters

### Procedure

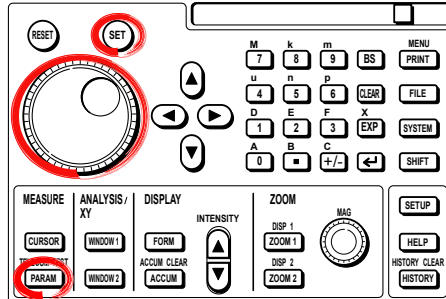

1. Press **PARAM**. The waveform parameter setting menu appears. If waveform parameters are already set, the waveform parameter measurement values appear.
2. Press the **Mode** soft key.
3. Press the **Basic** soft key.

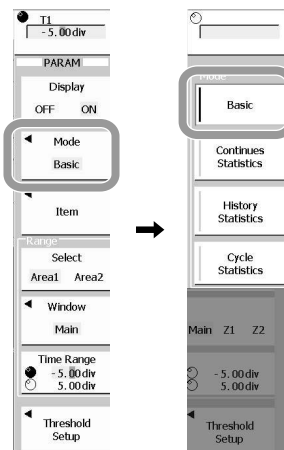

### Setting Measurement Items

4. Press the **Item** soft key.

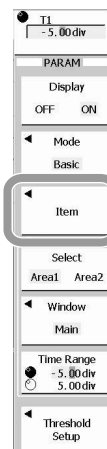

## 10.2 Automated Measurement of Waveform Parameters

- **Selecting the Area**

5. Press the **Area** soft key to select Area1 or Area2.

Another selection menu appears on products with firmware version 3.6 or later. Select Area1 or Area2 on that menu.

- **Selecting the Target Waveform**

6. Press the soft key for the measurement waveform, to select the waveform.

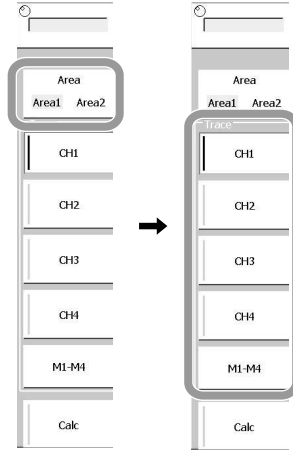

- **Selecting the Measurement Items**

7. With the **rotary knob**, select the items in the measurement item dialog box.

8. Press **SET** to switch ON/OFF.

Select ALL OFF and press **SET** to switch all items off.

Select Copy to All Trace and press **SET** to copy the current settings to all traces within the same area.

9. Repeat steps 6 to 8 as many times as required.

To set an equation, proceed to step 26 then press **ESC**.

To set High/Low Mode, Rise/Fall, or Delay, continue to the next step.

### Dialog box on products with firmware version 2.82 or later

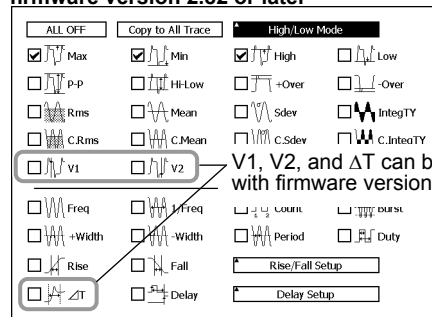
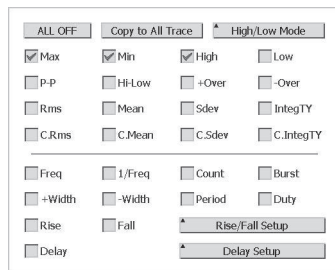

- **High/Low Mode Setting (the Method for Determining High and Low)**

10. With the **rotary knob**, select High/Low Mode, and press **SET**. The High/Low Mode menu appears.

11. Press the **Auto**, **Histogram**, or **Max-Min** soft key to select the method for determining High and Low.



- **Rise/Fall Settings (Setting Distal/Proximal Values)**
  12. With the **rotary knob**, select Rise/Fall Setup, and press **SET**. The Rise/Fall Setup menu appears.
  13. Press the **V/%** soft key, and set the units to V or %. The display units for the Distal and Proximal values change accordingly.
  14. Press the **Distal** soft key, to assign the rotary knob. With the rotary knob, set the distal value.
  15. Press the **Proximal** soft key, to assign the rotary knob. With the rotary knob, set the proximal value.
  16. Press the **ESC** soft key to return to the Item screen.
- **Setting the Delay (Edge Count and Reference Waveform Settings)**
  17. With the **rotary knob**, select Delay Setup, and press **SET**. The Delay Setup menu appears.
  18. Press the **Polarity** soft key, to select whether to count rising or falling edges.
  19. Press the **Count** soft key, to assign the rotary knob. With the rotary knob, set the edge detection count (how many edge counts the measurement point is delayed).
  20. Press the **Reference** soft key, to set the reference point to Trig Pos (trigger position) or Edge. If you select Trig Pos, the following step is not required.
- **Setting the Reference Point**
  21. Press the **Trace** soft key.
  22. Press the soft key for the reference waveform to select the reference waveform.
  23. Press the **Polarity** soft key, to select whether the reference edge is rising or falling.
  24. Press the **Count** soft key, and with the rotary knob select the edge detection count (the number of edges up to the reference point).
  25. Press the **ESC** soft key to return to the Item screen.

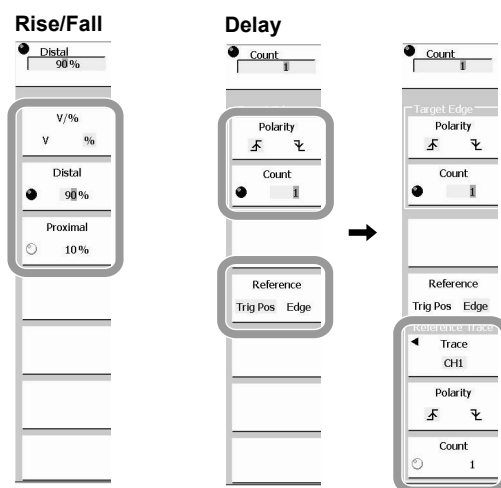

## 10.2 Automated Measurement of Waveform Parameters

- **Equation Settings (When Calculating with Waveform Parameters)**

26. Press the **Calc** soft key.
  - On products with firmware version 3.6 or later, pressing the **Area** soft key displays a selection menu. Press the **Calc** soft key on this menu.
27. With the **rotary knob**, select the calculation number, and press SET to add a check mark.
28. With the **rotary knob**, move the cursor to the equation whose calculation number is checked, and press SET. A screen for entering the equation appears.
29. Press the numerals on the panel to enter numerals. Use the **rotary knob** to select functions and operators to be used, and press SET. When equation entry is completed, press ENTER to confirm the equation.
30. Press **ESC**. This returns to the screen.
31. Press **ESC** to return to the item setting screen.

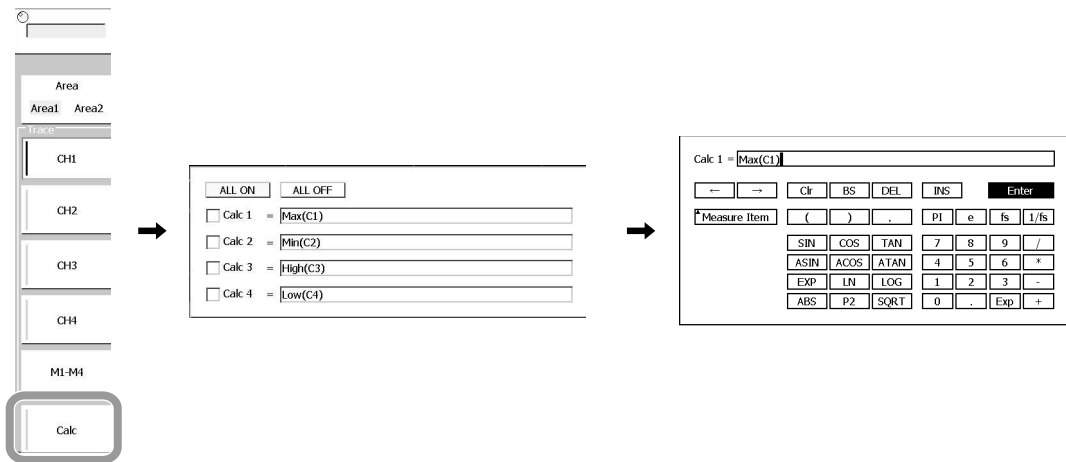

### Setting Measurement Ranges

- **Setting the Measurement Area**

32. Press the **Select Area1/Area2** soft key, to select the area.

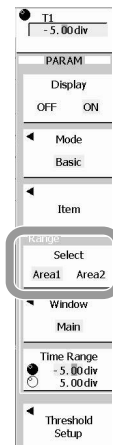

- **Selecting the Window for the Range**
  33. Press the **Window** soft key. The Window setting menu appears.
  34. Press the **Main**, **Zoom1**, **Zoom2** soft key, to select the window.

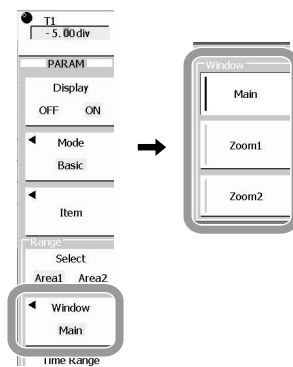

- **Specifying the Range**
  35. Press the **Time Range** soft key, to assign the rotary knob.
  36. With the **rotary knob**, set the start point T1 of the range.
  37. Repeat steps 33 and 34 to set the end point T2 of the range.

**Note**

The measurement is from -5 div to +5 div.

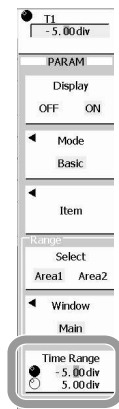

**Setting the Threshold Value (Threshold Setting for Items other than Rise and Fall)**

38. Press the **Threshold Setup** soft key. The menu appears.

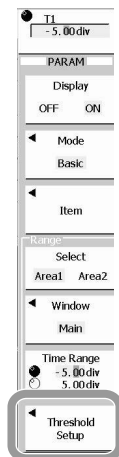



## 10.2 Automated Measurement of Waveform Parameters

- **Selecting the Measurement Waveform**

38. Press the soft key for the measurement waveform, to select the waveform.

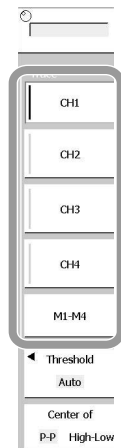

- **Selecting the Method of Setting Threshold Values**

40. Press the **Threshold** soft key.

41. Select the setting method, and press the corresponding soft key.

If you select Auto, continue to step 42.

If you select Level/Hys, continue to step 43.

If you select Upper/Lower, continue to step 47.

- **Auto**

42. Press the **Center of** soft key, to select P-P or High-Low.

- **Level/Hys**

43. Press the **Level/Hys** soft key, to assign the rotary knob to the threshold level.

44. Turn the **rotary knob**, to set the threshold level.

45. Press the **Level/Hys** soft key, to assign the rotary knob to the threshold hysteresis.

46. Turn the **rotary knob**, to set the threshold hysteresis.

- **Upper/Lower**

47. Press the **Upper/Lower** soft key, to assign the rotary knob to the threshold upper limit.

48. Turn the **rotary knob**, to set the threshold upper limit.

49. Press the **Level/Hys** soft key, to assign the rotary knob to the threshold lower limit.

50. Turn the **rotary knob**, to set the threshold lower limit.

51. Press **ESC**. This returns to the Measure menu.

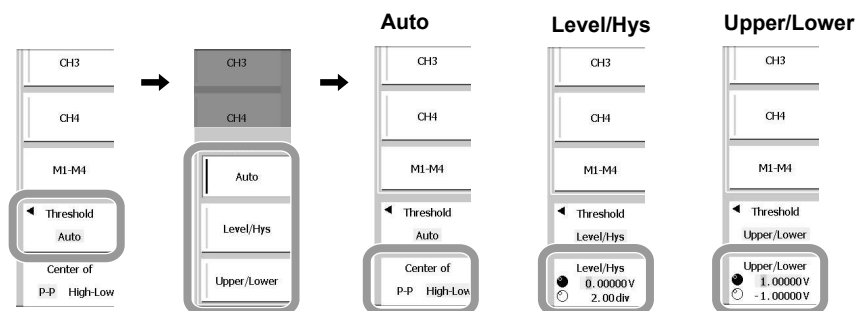

**Explanation**

**Limitations**

Automated measurement of waveform parameters cannot be performed on the following waveforms.

- Snapshot waveforms
- Accumulated waveforms other than the most recent

**Measurement Items**

Select from the 26 measurement items and delay measurement items (29 on products with firmware version 3.6 or later). (The items in parentheses are displayed on the screen.)

- A maximum of 100,000 data values can be saved in all areas and all traces (CH1 to CH4, M1 to M4).
- The screen display can show a maximum of 16 waveforms in total.

• **Measurement Items on the Voltage-Axis**

<b>Max (Max):</b>	Max voltage [V]	<b>Rms (Rms):</b>	RMS voltage [V] $(1/\sqrt{n})(\sum(x_i^2))^{1/2}$
<b>Min (Min):</b>	Min voltage [V]	<b>Mean (Mean):</b>	Average voltage [V] $(1/n)\sum x_i$
<b>High (High):</b>	High voltage [V]	<b>Sdev (Sdev):</b>	Standard deviation [V] $(\sum(x_i^2) - (\sum x_i)^2/n)/n)^{1/2}$
<b>Low (Low):</b>	Low voltage [V]	<b>IntegTY (ITY):</b>	Total area for both positive and negative amplitudes [Vs]
<b>P-P (P-P):</b>	P-P value (Max – Min) [V]		
<b>Hi-Low (Hi-Low):</b>	High voltage – Low voltage [V]		
<b>+Over (+Over):</b>	Amount of overshoot [%] $(\text{Max} - \text{High})/(\text{High} - \text{Low}) \times 100$		
<b>-Over (-Over):</b>	Amount of undershoot [%] $(\text{Low} - \text{Min})/(\text{High} - \text{Low}) \times 100$		

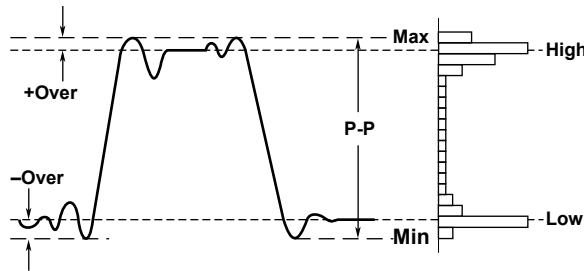

- C.Rms(CRms) : Rms value over the largest integer multiple of the period within the measurement range [V]
- C.Mean(CMean) : Average voltage over the largest integer multiple of the period within the measurement range [V]
- C.Sdev(CSdev) : Standard deviation over the largest integer multiple of the period within the measurement range [V]
- C.Integ(CITY) : Average of the positive and negative areas of the amplitude for each period [Vs]

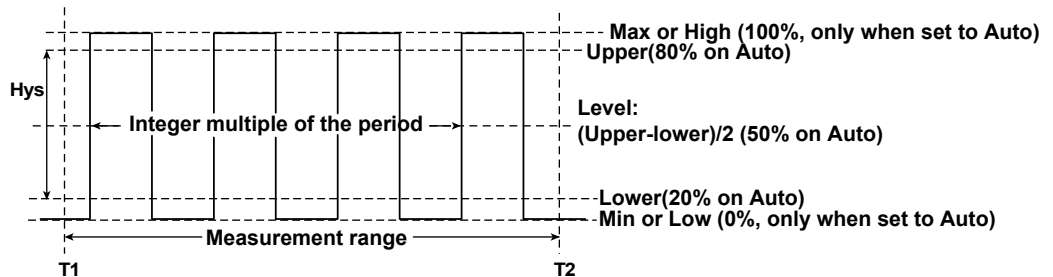

- V1(V1(•••)): Voltage at the intersection of each trace and T1 (left cursor defining the measurement range)
- V2(V2(•••)): Voltage at the intersection of each trace and T2 (right cursor defining the measurement range)
- $\Delta T(\Delta T(•••))$ : Time difference between T1 and T2
- \* The trace name is inserted in •••. For example, C1 is inserted for CH1 and M1 is inserted for M1.
- V1, V2, and  $\Delta T$  can be used on products with firmware version 3.6 or later.

## 10.2 Automated Measurement of Waveform Parameters

- **Measurement Items on the Time-Axis**

Freq(Freq) : Average frequency within the measurement range [Hz]  
 1/Freq : Average period within the measurement range [s]  
 Count : Edge count[No units]

**For Count = 4**

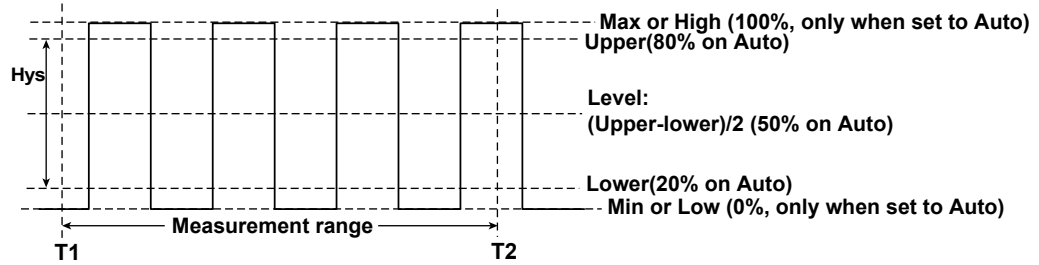

Burst: Burst width [s]

Set the measurement range (T-Range) according to the burst width you wish to measure.

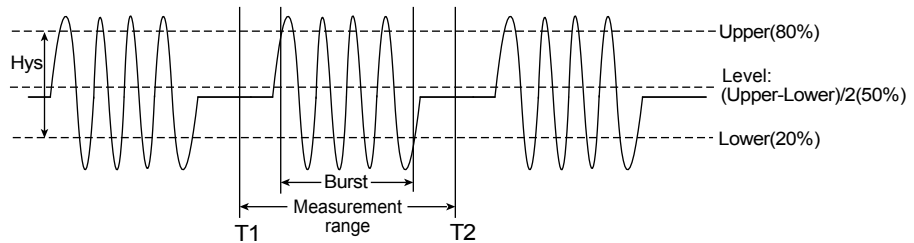

+Width(+Width) : Time width above the reference line (Level) [s]

-Width(-Width) : Time width below the reference line (Level) [s]

Period(Period) : Period [s]

Duty(Duty) : Duty ratio (+Width / Period x 100) [%]

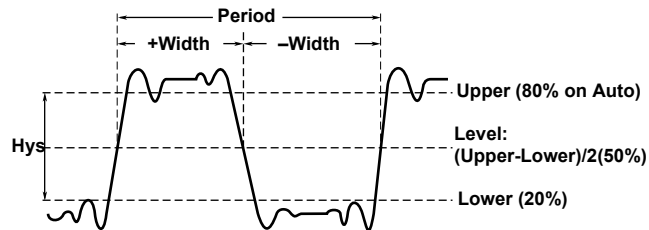

Rise(Rise) : Rise time [s]

Fall(Fall) : Fall time [s]

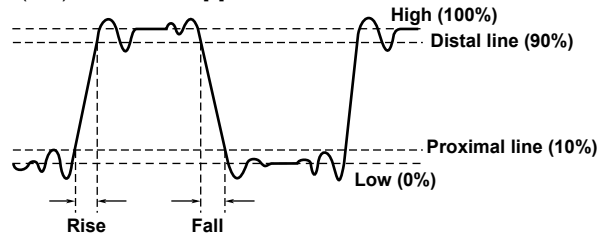

- **Other Measurement Items**

Delay (Dly): Delay time [s]

### Delay Setup

Measures the time difference between trace waveforms or the time difference from the trigger point to the rising or falling edge (delay between waveforms).

Below is an example for the rising edge (when Reference is set to Edge).

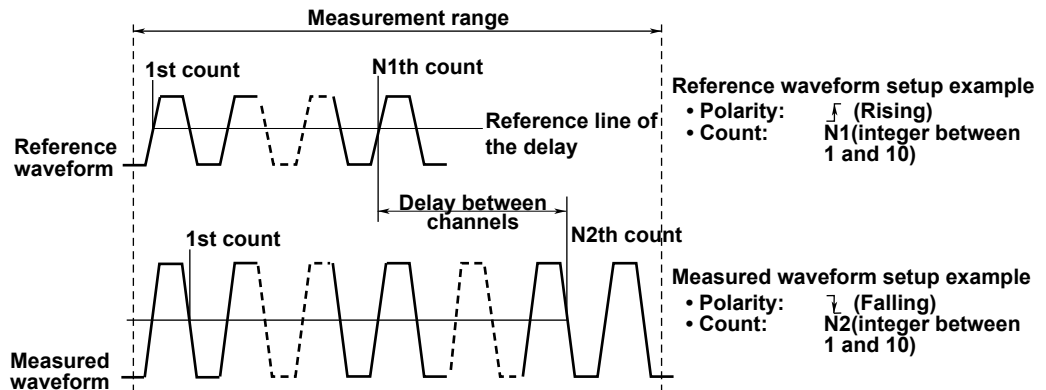

- The reference position of the delay measurement between waveforms varies on the Reference setting.
  - Edge: An edge of the reference waveform
  - Trig Pos: The trigger position
- With Edge Polarity, select whether the detected edge is  $\uparrow$  (rising) or  $\downarrow$  (falling). The default value is rising.
- Set which edge is to be the detection point (reference point or measurement point) using Count. The selectable range is an integer from 1 to 9. The default value is 1.
- The voltage level at the detection point is the reference line of the delay.
  - The reference line of the delay varies depending on the threshold setting as follows:
    - Auto: 50% of the P-P value or Hi-Lo value
    - Level/Hys: The specified threshold level
    - Upper/Lower: (Upper-Lower)/2
- When the measurement value is displayed, the measurement item name is "Dly".

### Determining High/Low

You can select the method by which the 100% level (High) and 0% level (low) are determined for measurement of High/Low/Hi-Low, Rise/Fall time, and other values of measurement parameters.

#### Auto

Relative to the frequency of appearance of the measured waveform's voltage levels, you can set levels within the measuring range with higher amplitudes to High and lower levels to Low, taking ringing, spikes, and other phenomena into account. This method is appropriate when measuring square and pulse waves.

#### Histogram

Sets High and Low to the maximum frequencies in the histogram. This method is appropriate when measuring waveforms whose maximum frequencies protrude, such as rectangular waves.

#### MAX-MIN

Sets High to the maximum value (MAX) within the measuring range and Low to the minimum (MIN) value. This method is appropriate for measuring waves such as sine or saw waves. It is not suitable for waveforms with ringing or spikes.

## 10.2 Automated Measurement of Waveform Parameters

---

### Setting the Measurement Range

In the default setting, the measurement range is  $\pm 5$  div of the time axis display frame, but the range can be restricted. The measurement range is determined by the two vertical cursors. The broken line position is the measurement start point, and the 1 point chain line position is the measurement end point.

The measurement range can be thought of in the same way as the setting range of the cursor display positions for cursor measurement.

### Threshold Settings

- Auto: The threshold values are found from P-P or High-Low, and set automatically.
- Level/Hys: Set with the rotary knob.
- Upper/Lower: Set with the rotary knob (for burst measurement).

### Notes on Automatic Measurement of Waveform Parameters

- If measurement is not possible, the measurement value is shown as “\*\*\*”.
- For waveforms of small amplitude, correct measurements may not be possible.
- If there are two or more cycles of the waveform within the measurement range, the time axis parameters (+Width, –Width, Period, Duty) are measured for the first cycle.
- To stop automatic measurement, set Mode to OFF. The processing stops at that point.

## 10.3 Performing Statistical Processing of the Measured Values of Waveform Parameters

### Procedure

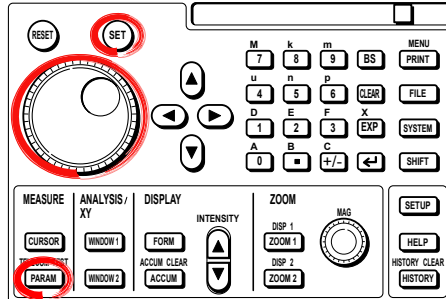

#### Normal Statistical Processing Settings

1. Press **PARAM**.
2. Press the **Mode** soft key.
3. Press the **Continuous Statistics** soft key.
4. Press the **Item** soft key.
5. Press the soft key for the measurement waveform, to select the waveform.
6. With the **rotary knob**, move the cursor to the item you want to set to ON.
7. Follow steps 8 to 24 of the procedure for automatic measurement of waveform parameters (pages 10-20 to 10-21), to set the measurement items.
8. Repeat steps 5 to 7 as many times as required. Press **ESC**.
9. With the **rotary knob**, set Count (number of statistical operations).
10. To clear the statistics results, and restart statistical processing, press the **Restart** soft key.

Other setting items are the same as for automatic measurement of waveform parameters (See Section 10.2, steps 24 and following).

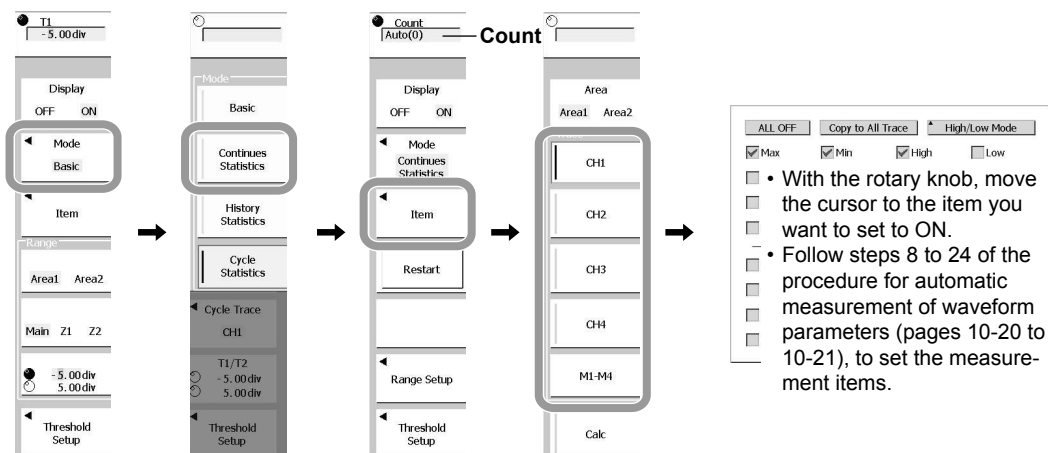

### 10.3 Performing Statistical Processing of the Measured Values of Waveform Parameters

#### Cycle Statistics Processing Settings

1. Press **PARAM**.
2. Press the **Mode** soft key.
3. Press the **Cycle Statistics** soft key.
4. Press the **Item** soft key.
5. Press the soft key for the measurement waveform, to select the waveform.
6. With the **rotary knob**, move the cursor to the item you want to set to ON. Follow steps 8 to 23 of the procedure for automatic measurement of waveform parameters (pages 10-20, 10-21, and set the measurement items.
7. Press the **Cycle Trace** soft key. A cycle waveform selection menu appears.
8. Press the soft key corresponding to the cycle channel.

Other setting items are the same as for automatic measurement of waveform parameters (Excluding Area. See Section 10.2, steps 10 and following).

#### Carrying Out Statistical Processing

9. Press the **EXEC** soft key. This carries out the statistical processing. The EXEC legend changes to "Abort". To abort the measurement and statistical processing, press the Abort soft key. This aborts measurement/statistical processing, and the Abort legend changes to "EXEC".

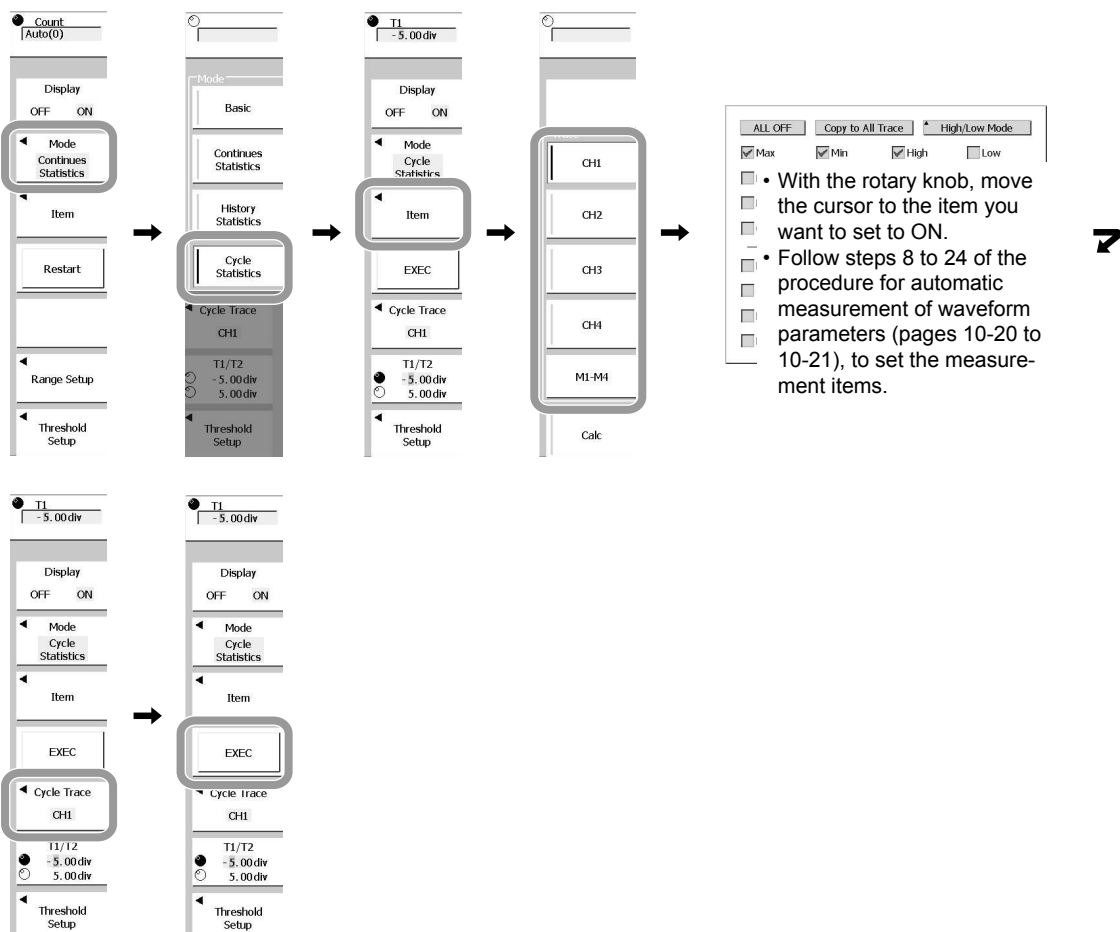

**Settings for Statistical Processing of History Data**

1. Press **PARAM**.
2. Press the **Mode** soft key.
3. Press the **History Statistics** soft key.
4. Press the **Item** soft key.
5. Select the waveform to be measured from **CH1** to **CH4** and **M1** to **M4**, and press the corresponding soft key.
6. With the **rotary knob**, move the cursor to the item you want to set to ON.
7. Follow steps 8 to 24 of the procedure for automatic measurement of waveform parameters (pages 10-20, 10-21), and set the measurement items.

Other setting items are the same as for automatic measurement of waveform parameters (See Section 10.2, steps 10 and following).

**Carrying Out Statistical Processing**

8. Press the **EXEC** soft key. This carries out the statistical processing. The EXEC legend changes to "Abort". To abort the measurement and statistical processing, press the Abort soft key. This aborts measurement/statistical processing, and the Abort legend changes to "EXEC".

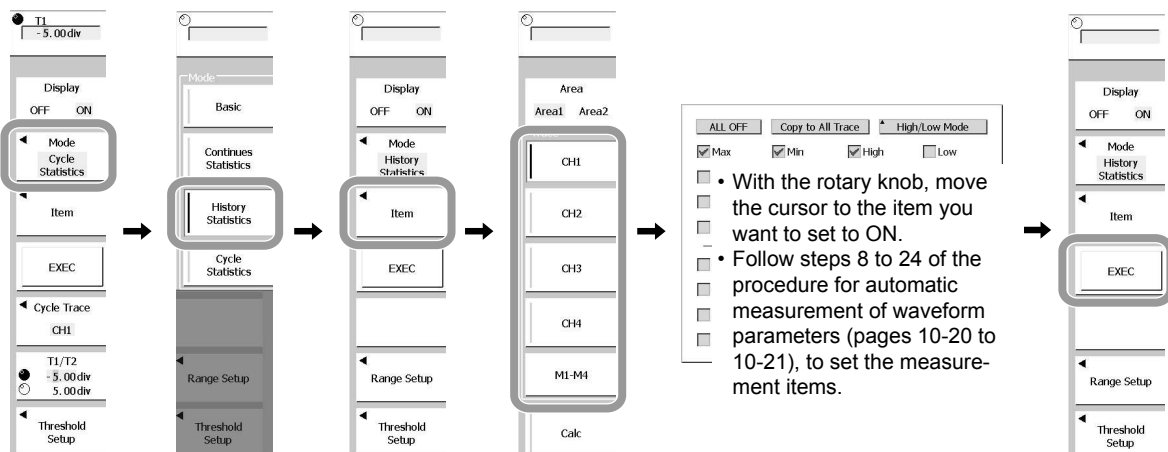

**Explanation**

Statistical processing is performed on the same measurement items as those of the automated measurement of waveform parameters. For the measurement values of the three automatic measurement items, the following five statistical results are shown.

- Max: Maximum value
- Min: Minimum value
- Mean: Average value
- $\sigma$ : Standard deviation
- Cnt: Number of measured values used in the statistical processing

For example, if you selected P-P of CH1 as a measurement parameter, the maximum, minimum, average, standard deviation, and the number of measured values used in the statistical processing of the P-P of CH1 are displayed.

Two statistical results can be shown for each of the automatic measurement items. If three or more automatic measurement items are selected, the first two items are shown, in ascending order of channel, and in the sequence in the Item Setup automatic measurement item selection menu (P-P, High-Low, Max, Min..., Init1XY, Init2XY).

Example 1: With CH1: P-P, High-Low, CH2: Min, CH3: Max, Min selected

Display shows CH1: P-P, CH2: Min

Example 2: With CH1: Max, Min, CH2: P-P, High-Low selected

Display shows CH1: Max, Min



### 10.3 Performing Statistical Processing of the Measured Values of Waveform Parameters

---

Statistical results not displayed can be read by the following methods.

- Using the communications function to read into a computer.
- Saving the statistical results as automatic measurement of waveform parameters (see Section 13.9), then reading into a computer.

There are three types of statistical processing: normal statistical processing, cycle statistical processing, and history data statistical processing.

#### **Normal Statistical Processing (Continuous Statistics)**

While acquiring a waveform, statistical processing is carried out on the entire waveform up to the current point. The number of measurement values (Cnt) to which statistical processing applies is the number of waveform samples acquired up to this point. Setting a new automatic measurement item for statistical processing, either during waveform acquisition, or while waveform acquisition is stopped, resets the count (Cnt) to 1.

#### **Cycle Statistical Processing (Cycle Statistics)**

The cycle of the displayed waveform is determined in order from the oldest data, the selected parameters for automated measurement are measured on the data within the cycle, and statistical processing is performed. The cycle is determined in the same fashion as the Period for the normal waveform parameters. The period of the specified waveform is applied to all waveforms.

- CH1 to CH4, M1 to M4: Performs automated measurement of waveform parameters on all target waveforms per cycle of the specified channel, and performs statistical processing.

Statistical processing is carried out for each cycle in sequence from the oldest data for the displayed waveforms.

The following parameters cannot be selected as measurement items.

Freq (average frequency), 1/Freq (average period), Count (edge count),  $\Delta T$ , and Delay

#### **History Data Statistical Processing (History Statistics)**

Statistical processing is carried out on automatic measurement items for waveforms acquired using the history memory function. Statistical processing is carried out in sequence from the oldest waveform. The waveforms for statistical processing are the waveforms displayed with ShowMap.

#### **Target Waveforms**

CH1 to CH4, M1 to M4

#### **Automatic Measurement Items for Statistics**

Statistical processing applies to the waveform automatic measurement parameters in Section 10.2. Statistical processing results can only be displayed for two automatic measurement items.

#### **Measurement Range for Statistics**

This is the same as the measurement range set for automatic measurement of waveform parameters (See Section 10.2).

#### **Notes on Statistical Processing**

During statistical processing, all soft keys other than Abort are disabled.

## 10.4 Zooming the Waveform

### Procedure

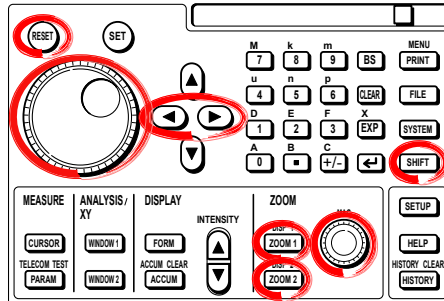

### Setting the Display Format for Zoomed Waveforms

1. Push **SHIFT + ZOOM1** or **ZOOM2**.
2. Press the **Format** soft key.
3. Press the soft key corresponding to the desired format.

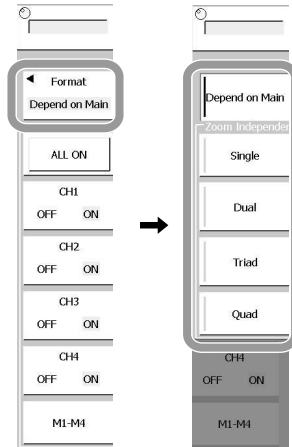

### Setting the Waveform to be Displayed

4. Press the soft key for the desired waveform and select ON or OFF. To select M1 to M4, first press the **M1-M4** soft key.

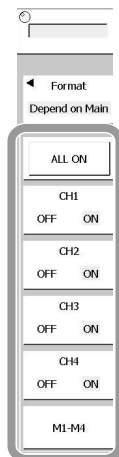

**Selecting the Zoom Method**

5. Push **ZOOM1** or **ZOOM2**.
6. Press the **Zoom** soft key and select ON or OFF.  
If you select OFF, the following operations have no effect.

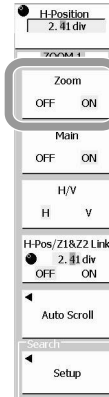

**Selecting Whether to Display the Main Screen**

7. Press the **Main** soft key and select ON or OFF. (If OFF is selected for Zoom then this can't be turned OFF.)

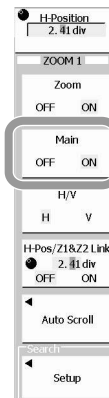

**Selecting the Zoom Method**

8. Press the **H/V** soft key to select the zoom method.  
H: time direction  
V: voltage direction

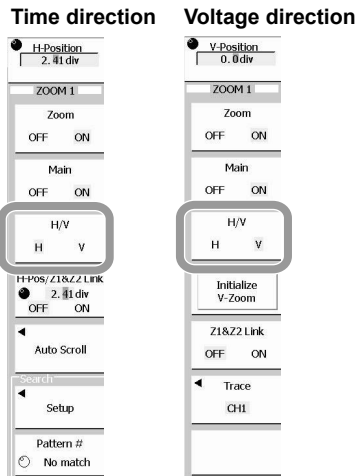

**Selecting the Zoom Method**

- Set the zoom ratio with the **MAG dial**. The zoom ratio is displayed in the upper right of the screen.

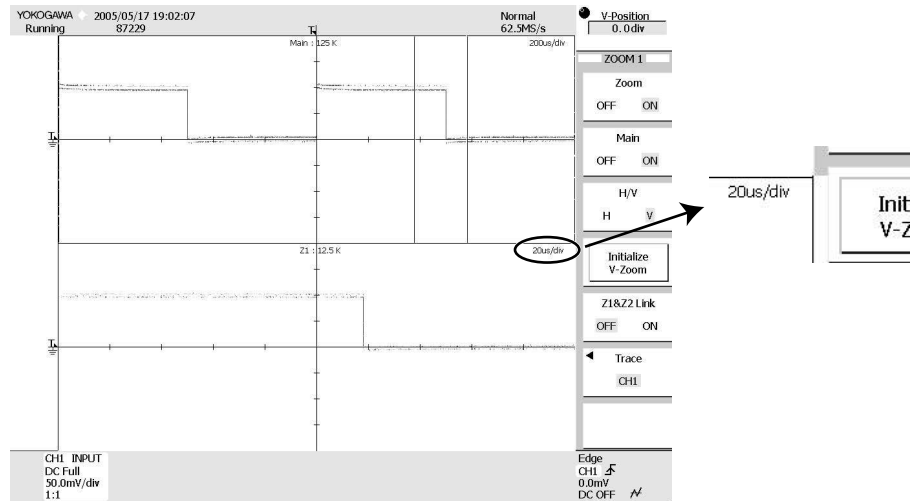

**Setting the Zoom Position (in the Time Direction)**

- Set the zoom position with the **rotary knob**.  
If you press RESET, the zoom position is reset to 0.00 div.  
The column can be moved with the arrow keys.

**Time direction**

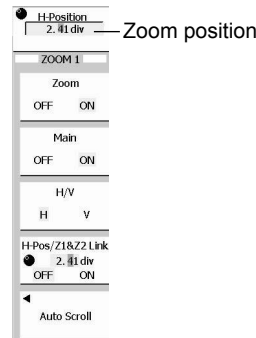

**Voltage direction**

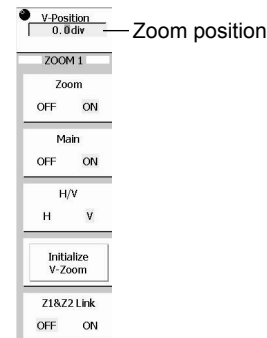

**Auto Scrolling the Waveform Zoom**

The procedure after selecting H for the zoom method in step 8 on previous page.

- Press the **Auto Scroll** soft key.
- Press the **Down** or **Up** soft key to switch the scroll speed.
- Press the **<<Play, Play >>**, **Stop** (|◀, ▶|, ▶|, ■) on products with firmware version 1.80 or later) soft key to execute or stop the auto scroll operation.

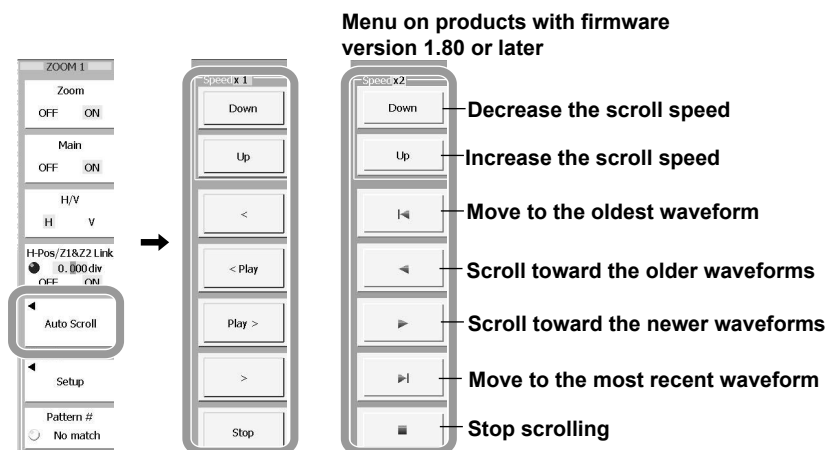

**Setting the Linking of ZOOM1 and ZOOM2**

11. Press the **H/V** soft key and set it to H or V.
12. When H is selected press the **H-Pos/Z1&Z2 Link** soft key, and when V is selected press the **Z1&Z2 Link** soft key, to select ON or OFF.

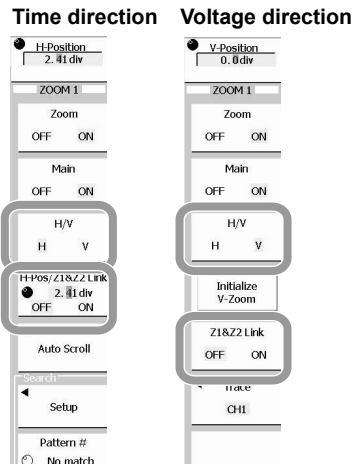

**Selecting Tracing in the Voltage Direction**

13. Press the **Trace** soft key.
14. Press the soft key corresponding to the desired channel. To select M1 to M4, first switch by pressing the **M1-M4** soft key.

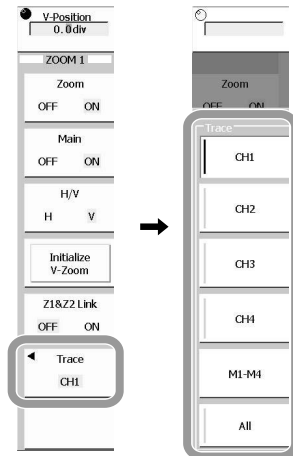

**Initializing the Voltage Zoom**

15. Press the **Initialize V-Zoom** soft key.

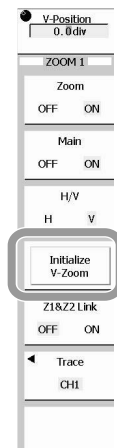

**Explanation**

Zoomed waveforms in two locations can be displayed simultaneously (dual zoom). You can also specify which channels to zoom. Zooming is not possible if there are less than ten points displayed on the screen (or less than 50 points for FFT waveforms).

**Selecting the Waveform Zoom Method: Zoom**

OFF: Displays only the main (unzoomed) waveform.

ON: Displays only the zoomed waveform of zoom box Z1 or Z2.

**Selecting the Trace to be Zoomed: SHIFT + ZOOM1/ZOOM2**

Traces whose Allocations were turned ON in step 4 are zoomed. Traces whose Allocations have been turned OFF are not zoomed. You cannot zoom traces whose displays are turned OFF.

**Display Format of Zoomed Waveforms: Format**

As for unzoomed waveforms, you can select among six display formats (Depend on Main\*, Single, Dual, Triad, and Quad).

- \* If "Depend on Main" is selected then the same DISPLAY menu as for the Main Format appears.

**Zoom Ratio: MAG Dial**

- Specify the factor for the horizontal (H Zoom) and vertical (V Zoom) directions of ZOOM1 and ZOOM2.
- The zoom can be increased such that up to ten data points can be displayed horizontally in the Window, and up to a factor of 10 can be displayed vertically.
- You can specify independent horizontal and vertical zoom factors for ZOOM1 or ZOOM2.
- The horizontal zoom applies to the entire waveform displayed in the window.
- The vertical zoom applies only to the one waveform in the window that is specified.

**Zoom Position: H-Position / V-Position**

- The zoom position can be set by specifying the zoom center position (center of the zoom box) in the range of -5 to +5 divisions with the center of the waveform area set to 0 div. The following step is used.  
Zoom position step:  $T/\text{div} \times 10 / (\text{display record length})$
- The zoom box enclosed by solid lines is Z1 and the one enclosed by dashed lines is Z2. Since each box is independent, you can set the positions separately.

**Setting Linked Zoom: H-Pos/Z1&Z2 Link, Z1&Z2 Link**

ON: Set it while preserving the difference between the ZOOM1 and ZOOM2 voltage positions.

OFF: Do not preserve the difference between the ZOOM1 and ZOOM2 voltage positions.

**Voltage Zoom Initialization: Initialize V-Zoom**

Initialize the settings for the voltage zoom ratio and zoom position.

## 10.5 Zooming a Searched Portion

### Procedure

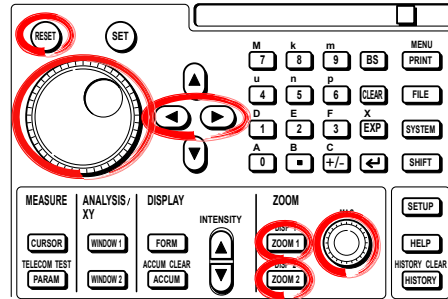

1. Push **ZOOM1** or **ZOOM2**. The ZOOM menu appears.
2. Press the **H/V** soft key, and select H.
3. Press the **Setup** soft key. This displays a menu used to set the search conditions.
4. Press the **Search Type** soft key. The menu appears for selecting the Search Type. Search types are the same as trigger types.
5. Press the soft key for the search condition.

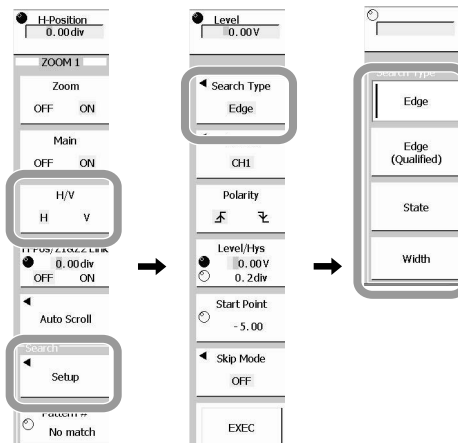

## Searching for an Edge

6. Select **Edge** in step 5 on page 10-38.

### Setting the Desired Waveform

7. Press the **Source** soft key. The menu appears for selecting the desired waveform.
8. Push the soft key for any of **CH1** to **CH4** or **M1** to **M4**.

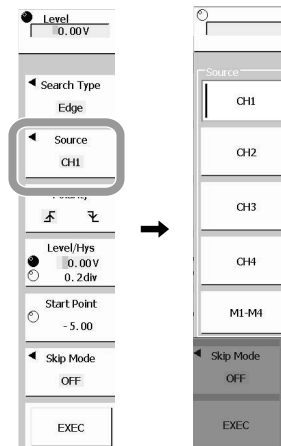

### Setting the Slope

9. Press the **Polarity** soft key to select  $\uparrow$  or  $\downarrow$ .

### Setting the Status Determination Level and Hysteresis

10. Press the **Level/Hys** soft key.
11. Use the **rotary knob** to set the search level and hysteresis. Pressing the soft key switches the rotary knob between the determination level and the hysteresis.

### Setting the Search Start Point

12. Press the **Start Point** soft key.
13. Set the search start point with the **rotary knob**.



**Setting Skip Mode**

- 14. Set skip mode when necessary.  
Press the **Skip Mode** soft key. The Skip Mode menu appears.
- 15. Press the soft key for **OFF**, **Hold Off**, or **Decimation**.
- 16. Press **ESC** to return to the previous screen.
- 17. Use the **rotary knob** to set the skip time or the number of searches.

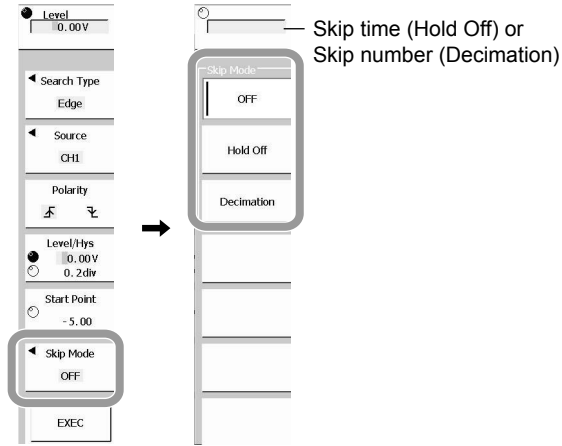

**Executing the Search**

- 18. Press the **Exec** soft key. The portion that satisfies the search condition is displayed in the zoom screen.

**Displaying the Search Result**

Proceed to step 28 on page 10-48.

**Searching for an Edge (Qualified)**

- 6. Select **Edge (Qualified)** in step 5 on page 10-38.

**Setting the Waveform**

- 7. Press the **Source** soft key. The menu appears for selecting the desired waveform.
- 8. Push the soft key for any of **CH1 to CH4** or **M1 to M4**.

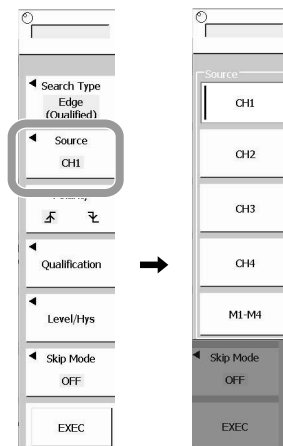

**Setting the Slope**

- 9. Press the **Polarity** soft key to select  $\uparrow$  or  $\downarrow$ .

### Setting the Qualification

10. Press the **Qualification** soft key. This displays a menu used to set the qualification.
11. Use the soft key to set the status of **CH1** to **CH4** and **M1** to **M4**.  
H: High, L: Low, X: No effect
12. Press the **Logic** soft key to select AND or OR.
13. Press **ESC** to return to the previous screen.

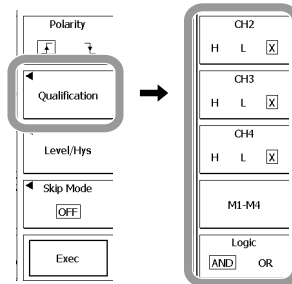

### Setting the Status Determination Level and Hysteresis

14. Press the **Level/Hys** soft key. The menu appears for setting the determination level and hysteresis.
15. Press the soft key for the waveform and use the **rotary knob** to set the determination level and hysteresis. Pressing the soft key switches the rotary knob between the determination level and the hysteresis.
16. Press **ESC** to return to the previous screen.

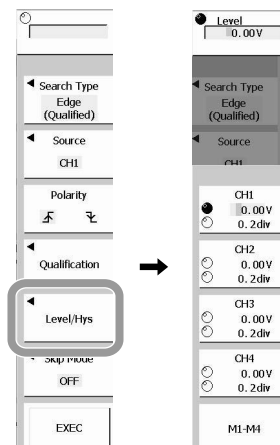

### Setting Skip Mode

17. Set skip mode when necessary.  
Press the **Skip Mode** soft key. The Skip Mode menu appears.
18. Press the soft key for **OFF**, **Hold Off**, or **Decimation**.
19. Use the **rotary knob** to set the skip time or the number of searches.
20. Press **ESC** to return to the previous screen.

### Executing the Search

21. Press the **Exec** soft key. The portion that satisfies the search condition is displayed in the zoom screen.

### Displaying the Search Result

Proceed to step 28 on page 10-48.

### Searching for a State

6. Select **State** in step 5 on page 10-38.

### Setting the State

7. Press the **State** soft key. This displays a menu used to set the state.
8. Use the soft key to set the status of **CH1 to CH4** and **M1 to M4**.  
 H: High, L: Low, X: No effect  
 Set the slope for the clock channel.
9. Press the **Logic** soft key to select AND or OR.
10. Press the **Clock** soft key. Displays a menu to select the clock channel.
11. Press the soft key for the waveform to set for the clock channel.
12. Press **ESC** to return to the previous screen.

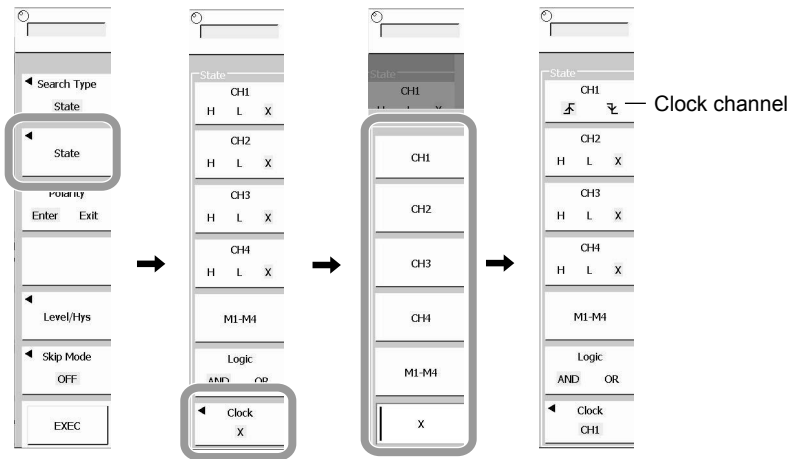

### Setting the Conditions

13. Press the **Polarity** soft key and select Enter or Exit.

### Setting the Status Determination Level and Hysteresis

14. Press the **Level/Hys** soft key. The menu appears for setting the determination level and hysteresis.
15. Press the soft key for the waveform and use the **rotary knob** to set the determination level and hysteresis. Pressing the soft key switches the rotary knob between the determination level and the hysteresis.
16. Press **ESC** to return to the previous screen.

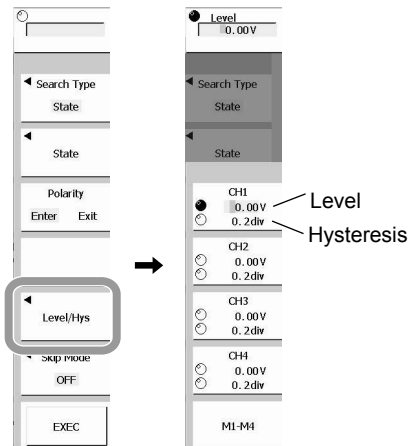

### Setting Skip Mode

17. Set skip mode when necessary.  
Press the **Skip Mode** soft key. The Skip Mode menu appears.
18. Press the soft key for **OFF**, **Hold Off**, or **Decimation**.
19. Use the **rotary knob** to set the skip time or the number of searches.
20. Press **ESC** to return to the previous screen.

### Executing the Search

21. Press the **Exec** soft key. The portion that satisfies the search condition is displayed in the zoom screen.

### Displaying the Search Result

Proceed to step 28 on page 10-48.

## Searching for a Pulse Width

6. Select **Width** in step 5 on page 10-38.

### Setting the Type

7. Press the **Setup** soft key. This displays a menu used to set the type.
8. Press the **Pulse** soft key to set the type to Pulse.

### Setting the Mode

9. Press the **Mode** soft key. The menu appears for setting the determination method for the specified time.
10. Press the soft key for one of **More than**, **Less than**, **Between**, **Out of Range**, and **Time Out**.

### Setting the Determination Standard Time

11. Press the **Time** soft key and use the **rotary knob** to set the determination standard time.
12. Press **ESC** to return to the previous screen.

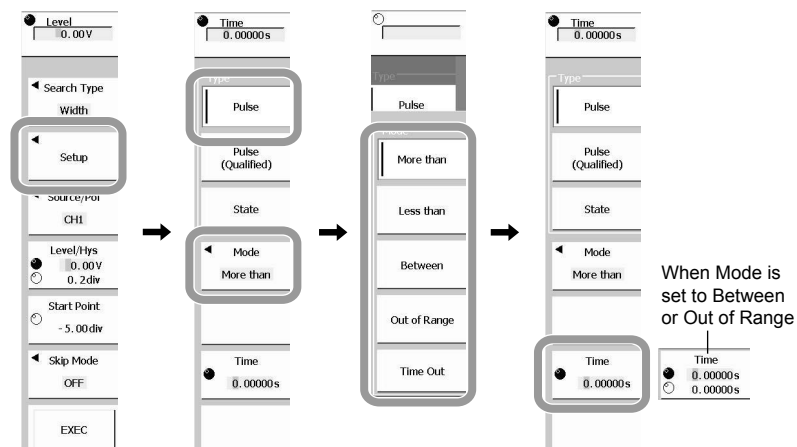

**Setting the Waveform and State Polarity**

- 13. Press the **Source/Pol** soft key. The menu appears for selecting the desired waveform.
- 14. Push the soft key for any of **CH1** to **CH4** or **M1** to **M4**.
- 15. Press the **Polarity** soft key and set the state polarity to Pos or Neg.
- 16. Press **ESC** to return to the previous screen.

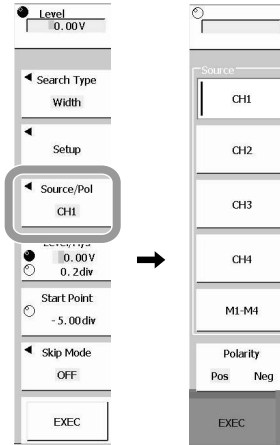

**Setting the Status Determination Level and Hysteresis**

- 17. Press the **Level/Hys** soft key.
- 18. Use the **rotary knob** to set the determination level and hysteresis. Pressing the soft key switches the rotary knob between the determination level and the hysteresis.

**Setting the Search Start Point**

- 19. Press the **Start Point** soft key.
- 20. Set the search start point with the **rotary knob**.

**Setting Skip Mode**

- 21. Set skip mode when necessary.  
Press the **Skip Mode** soft key. The Skip Mode menu appears.
- 22. Press the soft key for **OFF**, **Hold Off**, or **Decimation**.
- 23. Use the **rotary knob** to set the skip time or the number of searches.
- 24. Press **ESC** to return to the previous screen.

**Executing the Search**

- 25. Press the **Exec** soft key. The portion that satisfies the search condition is displayed in the zoom screen.

**Displaying the Search Result**

Proceed to step 28 on page 10-48.

## Searching for a Pulse Width (Qualified)

6. Select **Width** in step 5 on page 10-38.

### Setting the Type

7. Press the **Setup** soft key. This displays a menu used to set the type.
8. Press the **Pulse (Qualified)** soft key to set the type to Pulse (Qualified).

### Setting the Mode

9. Press the **Mode** soft key. The menu appears for setting the determination method for the specified time.
10. Press the soft key for one of **More than**, **Less than**, **Between**, **Out of Range**, and **Time Out**.

### Setting the Determination Standard Time

11. Press the **Time** soft key and use the **rotary knob** to set the determination standard time.
12. Press **ESC** to return to the previous screen.

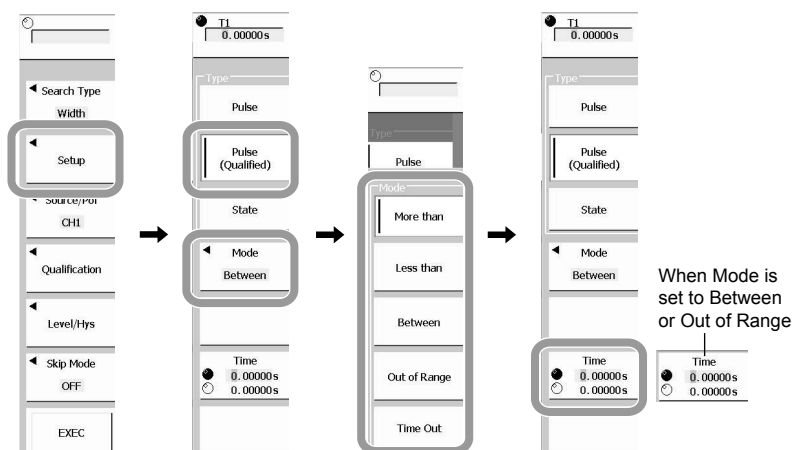

### Setting the Waveform and State Polarity

13. Press the **Source/Pol** soft key. The menu appears for selecting the desired waveform.
14. Push the soft key for any of **CH1** to **CH4** or **M1** to **M4**.
15. Press the **Polarity** soft key and set the state polarity to Pos or Neg.
16. Press **ESC** to return to the previous screen.

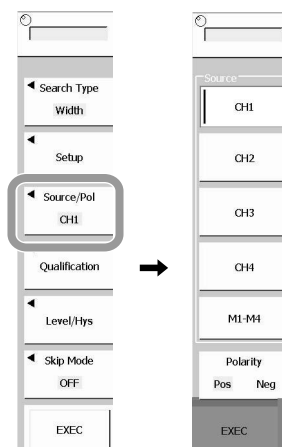

**Setting the Qualification**

17. Press the **Qualification** soft key. This displays a menu used to set the qualification.
18. Use the soft key to set the status of **CH1 to CH4** and **M1 to M4**.  
H: High, L: Low, X: No effect
19. Press the **Logic** soft key to select AND or OR.
20. Press **ESC** to return to the previous screen.

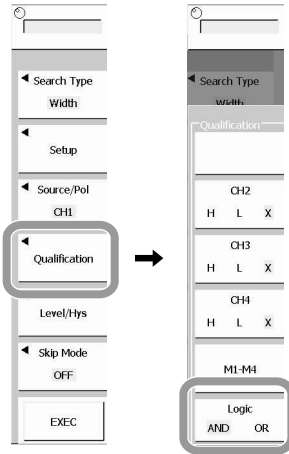

**Setting the Status Determination Level and Hysteresis**

21. Press the **Level/Hys** soft key. The menu appears for setting the determination level and hysteresis.
22. Press the soft key for the waveform and use the **rotary knob** to set the determination level and hysteresis. Pressing the soft key switches the rotary knob between the determination level and the hysteresis.
23. Press **ESC** to return to the previous screen.

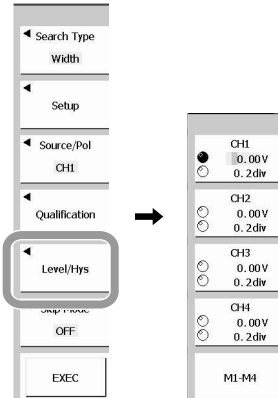

**Setting Skip Mode**

24. Set skip mode when necessary.  
Press the **Skip Mode** soft key. The Skip Mode menu appears.
25. Press the soft key for **OFF**, **Hold Off**, or **Decimation**.
26. Use the **rotary knob** to set the skip time or the number of searches.
27. Press **ESC** to return to the previous screen.

**Executing the Search**

28. Press the **Exec** soft key. The portion that satisfies the search condition is displayed in the zoom screen.

**Displaying the Search Result**

Proceed to step 28 on page 10-48.

### Search for a State Condition Width

6. Select **Width** in step 5 on page 10-38.

#### Setting the Type

7. Press the **Setup** soft key. This displays a menu used to set the type.
8. Press the **State** soft key to set the type to State.

#### Setting the Mode

9. Press the **Mode** soft key. The menu appears for setting the determination method for the specified time.
10. Press the soft key for one of **More than**, **Less than**, **Between**, **Out of Range**, and **Time Out**.

#### Setting the Determination Standard Time

11. Press the **Time** soft key and use the **rotary knob** to set the determination standard time.
12. Press **ESC** to return to the previous screen.

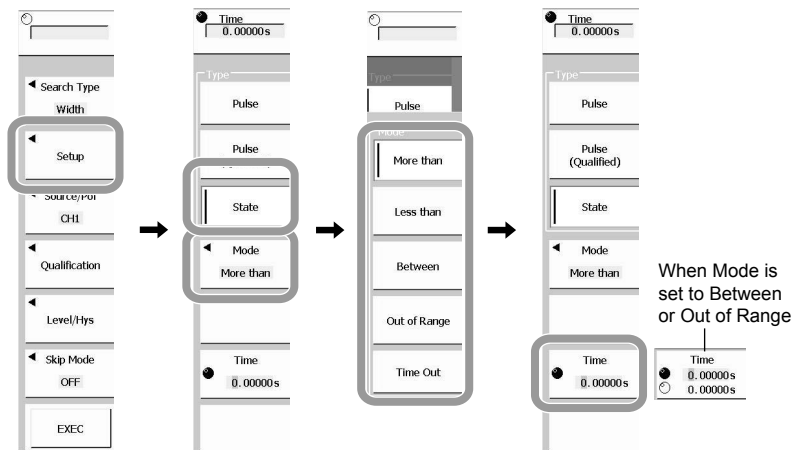

#### Setting the State

13. Press the **State** soft key. This displays a menu used to set the state.
14. Use the soft key to set the status of CH1 to CH4 and M1 to M4.  
H: High, L: Low, X: No effect  
Set the slope for the clock channel.
15. Press the **Logic** soft key to select AND or OR.
16. Press the **Clock** soft key. This displays a menu used to select the clock channel.
17. Press the soft key for the waveform to set for the clock channel.
18. Press **ESC** to return to the previous screen.

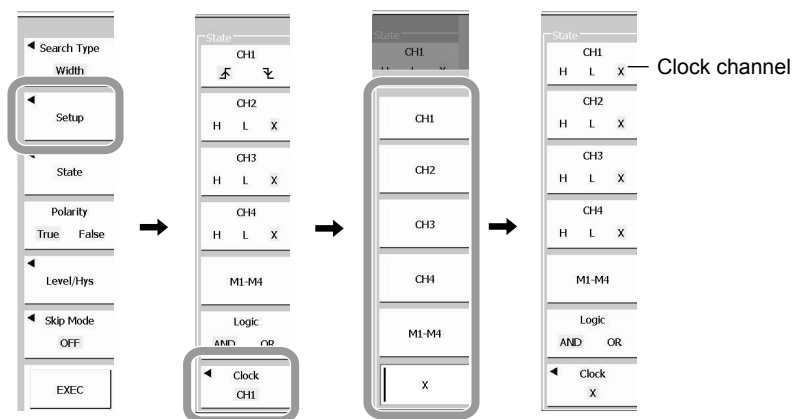



**Setting the Waveform and State Polarity**

19. Press the **Polarity** soft key and set the state condition to True or False.

**Setting the Status Determination Level and Hysteresis**

20. Press the **Level/Hys** soft key. The menu appears for setting the determination level and hysteresis.
21. Press the soft key for the waveform and use the **rotary knob** to set the determination level and hysteresis. Pressing the soft key switches the rotary knob between the determination level and the hysteresis.
22. Press **ESC** to return to the previous screen.

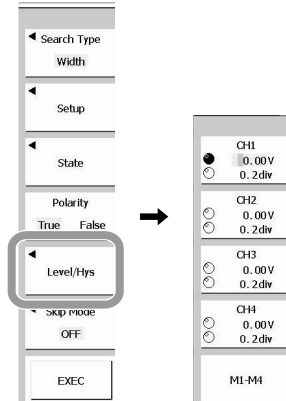

**Setting Skip Mode**

23. Set skip mode when necessary.  
Press the **Skip Mode** soft key. The Skip Mode menu appears.
24. Press the soft key for **OFF**, **Hold Off**, or **Decimation**.
25. Use the **rotary knob** to set the skip time or the number of searches.
26. Press **ESC** to return to the previous screen.

**Executing the Search**

27. Press the **Exec** soft key. The portion that satisfies the search condition is displayed in the zoom screen.

**Displaying the Search Result**

28. Turn the **rotary knob** to select a search number.  
The waveform at the location of the search number is displayed in the zoom waveform area.

**Turning ON/OFF the Search Marks (applicable to products with firmware version 3.6 or later)**

29. Press **Pattern#/Mark** soft key to select ON or OFF.

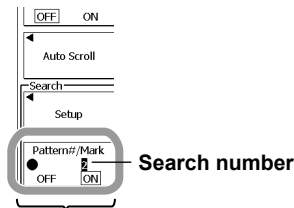

**Turning ON/OFF the Search Mark ▼**

Search marks can be displayed on the main window and zoom window to indicate the locations on the waveform that have been found. The search mark corresponding to the search number is highlighted (applies to products with firmware version 3.6 or later).

**Explanation**

Search for a portion of the displayed trace that satisfies a certain condition and magnify it.

**Search Type**

There are the following four types of searches. The search method is the same as for the Edge, State, or Width trigger. For details see section 2.4 or chapter 6.

- **Edge**

Search for a position where the trace of the specified channel crosses (rising or falling) a certain level. This is the same as the Edge trigger. (See section 6.7.)

- **Edge(Qualified)**

Search for a position such that the state of the trace satisfies the specified condition and the trace of a separately specified channel rises or falls to a certain level. This is the same as the Edge (Qualified) trigger. (See section 6.8.)

- **State**

Search for a position where the AND or OR of the trace states does or does not hold. This is the same as the State trigger. (See section 6.9.)

- **Width**

Search for a position where the trace pulse width satisfies a fixed condition. The following five conditions are available.

- More than: search for the final edge of a pulse longer than the specified time.
- Less than: search for the final edge of a pulse shorter than the specified time.
- Between: Search for the final edge of a pulse longer than the specified time T1 and shorter than T2.
- Out of Range: Search for the final edge of a pulse shorter than a specified time T1 or longer than T2.
- Time Out: Search for a position where the pulse width has exceeded the specified time.

There are the following three additional types of pulse widths.

- Pulse: Search for a relationship between the pulse width of a single source and a specified time.
- Pulse (Qualified): While each trace state satisfies a given condition, search for a relationship between the pulse width of a single source trace and a specified time.
- State: Searches for one of the following positions.
  - Position where the time during which the state condition is met or not met satisfies the relationship with the specified determination time.
  - The DL9000 checks the state condition on the rising or falling edge of the specified trace (clock channel) and normalizes the result (high if the state condition is met or low if not). A trigger is activated where the time during which the normalized condition is met or not met first satisfies the relationship with the specified time.

**Skip**

After searching a position that meets the search conditions, the subsequent positions that meet the search conditions are skipped for a specified time or a specified number of times.

OFF	Searches all sections that meet the search conditions.
Hold Off	Skips the search for a specified time.
Decimation	Skips a specified number of search positions.

**Note**

The number which can search is 5000.

## 10.6 Searching the Serial Pattern

This function can be used on products with firmware version 1.60 or later.

### Procedure

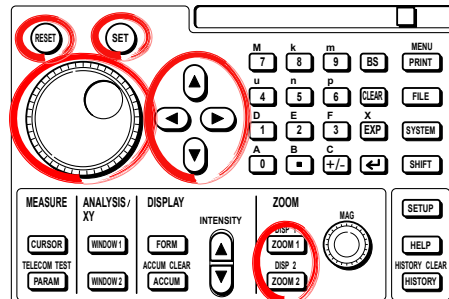

1. Press **ZOOM1** or **ZOOM2** to display the ZOOM menu.

### Selecting the Serial Pattern Search Function

2. Press the **H/V** soft key, and select H.
3. Press the **Setup** soft key.
4. Press the **Search Type** soft key to display the Search Type menu.
5. Press the **Serial** soft key to display the Serial Type menu.
6. Press the **Serial** soft key.

On models with the /F5, /F7, or /F8 option, I2C, LIN, and SPI are displayed as selectable items. For details on these functions and operations, see the *Serial Bus Signal Analysis Function User's Manual IM701310-51E*.

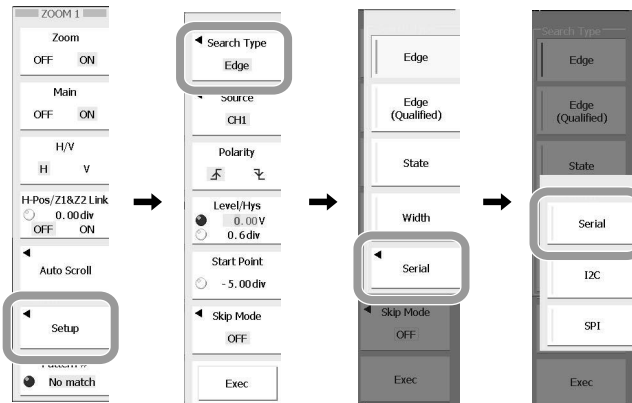

**Setting the Serial Pattern**

7. Press the **Setup** soft key.
8. Press the **Clock** soft key to select ON or OFF.
  - ON: Proceed to step 10. You must set the CS signal, clock source, and latch source (see page 10-52 and 10-3).
  - OFF: Proceed to step 9.
9. Turn the **rotary knob** to set the bit rate.
10. Press the **Set Pattern** soft key to display the data setup dialog box.

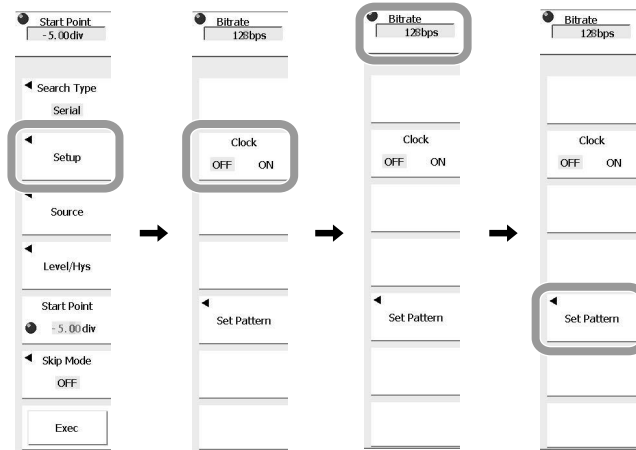

11. Set the search pattern according to the procedural explanation in the figure below.

**Pattern data area** (Up to 128 bits of data can be entered. Data exceeding 128 bits is discarded.)

The cursor position is the entry position.

0	1	2	3	4	5	6	7
00000	00010	00100	00110	01000	01010	01100	01110
8	9	A	X	\$	D	E	F
10000	10010	10100	XXXXX	111X0	11101	11110	11111
0	1	2	3	4	5	6	7
00000	00010	00100	00110	01000	01010	01100	01110
8	9	0	A	B	C	D	X
10000	10010	00000	10100	10110	11100	11101	XXXXX

When entering in hexadecimal notation

←	→	↑	↓	BS	DEL	Clr	INS		
0	1	2	3	4	5	6	7	8	9
A	B	C	D	E	F	X			

When entering in binary notation

←	→	↑	↓	BS	DEL	Clr	INS		
0	1	X							

Pattern Format: Bin Hex

←

→

↑

↓

DEL

INS

For the procedure to select Bin or Hex, move the cursor, and delete or insert data, see the section describing the trigger conditions of the serial pattern (page 6-68). The soft keys can also be used to select Bin or Hex, move the cursor, and delete or insert data.

12. Press **ESC** twice to go back two menus.

**Setting the Data Source**

13. Press the **Source** soft key to display the Data Source menu.
14. Press any of the **CH1 to CH4** and **M1-M4** soft keys to select the data source. Pressing the M1-M4 soft key opens the M1, M2, M3, and M4 soft keys.
15. Turn the **rotary knob** to set the level for determining the data source high and low.
16. Press **ESC** to return to the previous screen.
17. Press the **Active** soft key to select H or L.

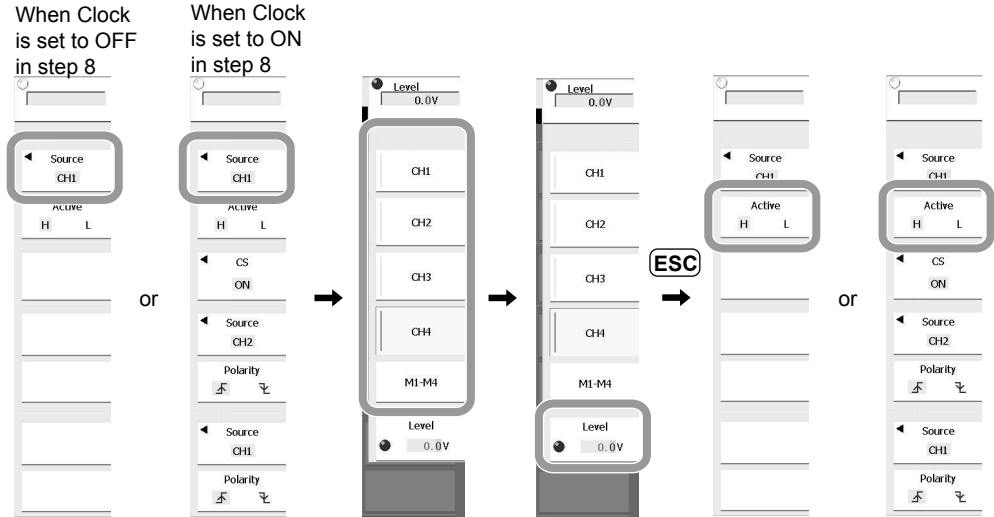

Carry out steps 18 to 32 below if you set the Clock to ON in step 8 on page 11-51.

**Setting the CS Signal**

18. Press the **CS** soft key to display the CS menu.
19. Press the **CS** soft key to select ON or OFF.
  - ON: Proceed to step 20.
  - OFF: Proceed to step 22.
20. Press each channel soft key to select H, L, or X. Pressing the M1-M4 soft key opens the M1, M2, M3, and M4 soft keys.
21. Press the **Logic** soft key to select AND or OR.
  - AND: Determines that the CS is detected when the conditions of all channels are met.
  - OR: Determines that the CS is detected when any of channel conditions is met.
22. Press **ESC** to return to the previous screen.

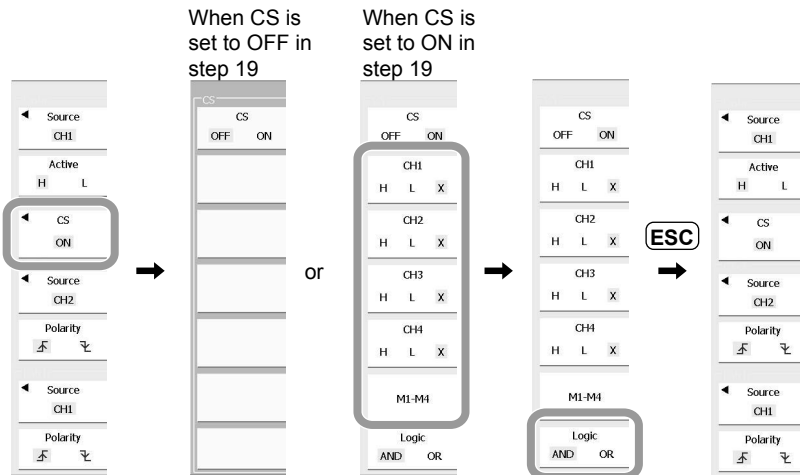

### Setting the Clock Source

23. Press the **Source** soft key to display the Clock Source menu.
24. Press any of the **CH1** to **CH4** and **M1-M4** soft keys to select the clock source. Pressing the M1-M4 soft key opens the M1, M2, M3, and M4 soft keys.
25. Turn the **rotary knob** to set the detection level of the clock source.
26. Press **ESC** to return to the previous screen.
27. Press the **Polarity** soft key to select  $\uparrow$  or  $\downarrow$ .

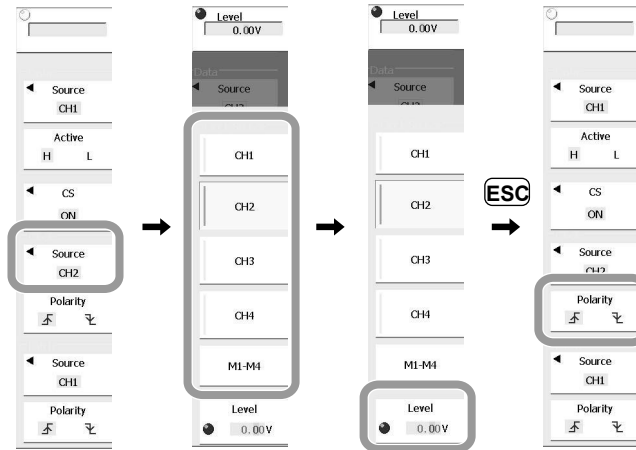

### Setting the Latch Source

28. Press the **Source** soft key to display the Latch Source menu.
29. Press any of the **CH1** to **CH4**, **M1-M4**, and **X** soft keys to select the latch source. Pressing the M1-M4 soft key opens the M1, M2, M3, and M4 soft keys.
30. Turn the **rotary knob** to set the detection level of the latch source.
31. Press **ESC** to return to the previous screen.
32. Press the **Polarity** soft key to select  $\uparrow$  or  $\downarrow$ .

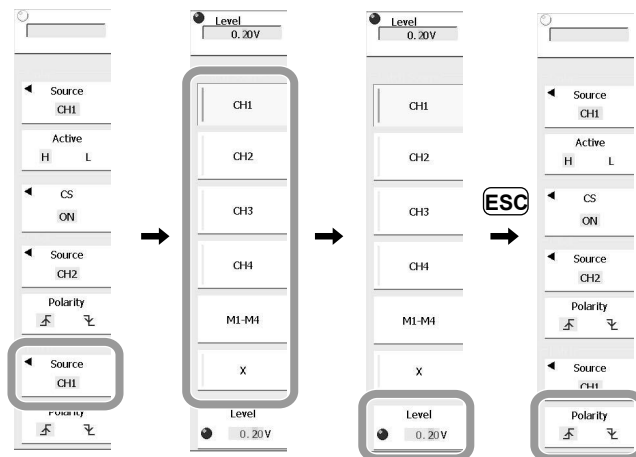

33. Press **ESC** to return to the previous screen.

**Setting the Status Determination Level and Hysteresis, the Search Start Point, and the Skip Mode**

34. Press the **Level/Hys** soft key.
35. Turn the **rotary knob** to set the determination level and hysteresis for each channel.  
Pressing the M1-M4 soft key opens the M1, M2, M3, and M4 soft keys.
36. Press **ESC** to return to the previous screen.
37. Turn the **rotary knob** to set the search start point.
38. Press the **Skip Mode** soft key to display the Skip Mode menu.
39. Press any of the **OFF**, **Hold Off**, and **Decimation** soft keys to select the skip mode.
40. Turn the **rotary knob** to set the hold off time (time to skip) and decimation time (number of times to skip the search) according to the selected skip mode.
41. Press **ESC** to return to the previous screen.

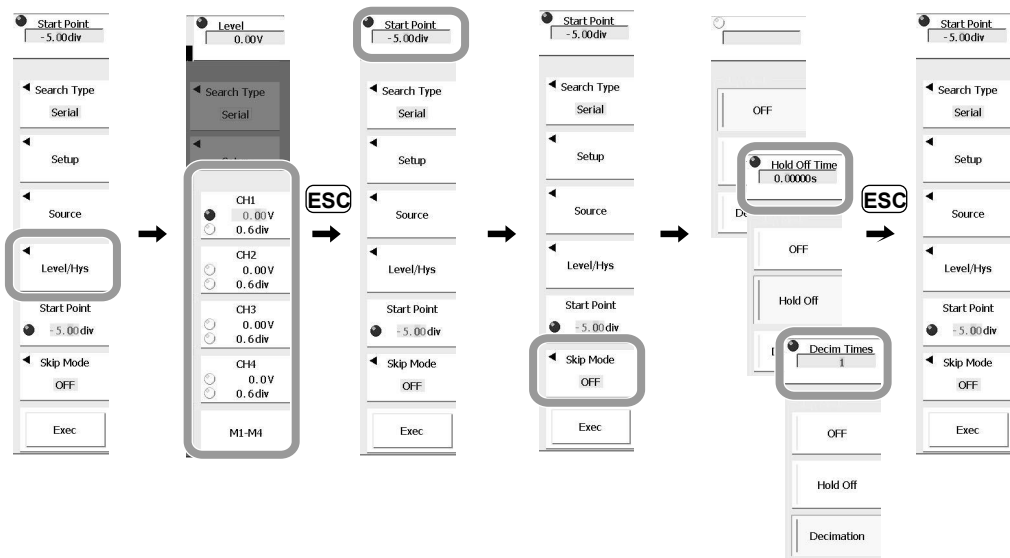

**Executing the Search**

42. Press the **Exec** soft key to execute the search. The Exec soft key changes to Abort. To abort the search, press this soft key.

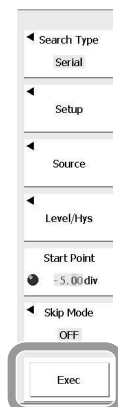

### Displaying the Search Result

43. Turn the **rotary knob** to select a search number.  
The waveform at the location of the search number is displayed in the zoom waveform area.

### Turning ON/OFF the Search Marks (applicable to products with firmware version 3.6 or later)

44. Press **Pattern#/Mark** soft key to select ON or OFF.

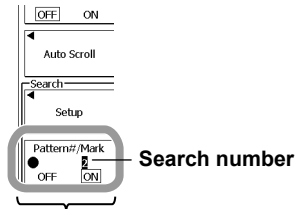

#### Turning ON/OFF the Search Mark ▼

Search marks can be displayed on the main window and zoom window to indicate the locations on the waveform that have been found. The search mark corresponding to the search number is highlighted as (applies to products with firmware version 3.6 or later).

### Explanation

This function searches serial status patterns. Search is made on a preset status pattern. This function can be used on products with firmware version 1.60 or later.

### Selecting the Serial Pattern Search Function

This section explains the serial pattern search function that comes standard on products with firmware version 1.60 or later. Other analysis functions for the serial bus are provided as options to the DL9000. For details on these functions and operations, see the *Serial Bus Signal Analysis Function User's Manual IM701310-51E*.

### Setting the Clock Source

This function searches the serial data pattern in sync with the selected clock signal. You can select whether to synchronize to the rising or falling edge of the clock.

ON: Select the clock source from CH1 to CH4 and M1 to M4.

OFF: Set the bit rate in the range of 1 k to 1 Gbps instead of selecting the clock source from the channels.

### Setting the Serial Data Pattern

You can specify a serial data pattern as a search condition. Up to 128 bits can be specified. When Pattern Format is set to Hex (hexadecimal), you can enter X, 0 to 9, or A to F in units of 4 bits. When Pattern Format is set to Bin (binary), you can enter X, 0, or 1 for each bit. Enter X when not using the value as a condition.

### Setting the Data Source

Select the data source for searching the serial data pattern from CH1 to CH4 and M1 to M4. You can also select high active or low active.



### Setting the CS Signal

You can control the period over which the data source is detected with the CS signal when the clock source is turned ON.

ON: Select the CS signal from CH1 to CH4 and M1 to M4. You can also select the signal level state (H, L, or X) when the data source is to be detected. Select X when not using the value as a condition. You can also specify AND or OR logic to the conditions of multiple channels.

OFF: Detects the data source at all times.

### Setting the Latch Source

You can select the timing when the acquired serial data pattern is compared against the pattern specified as a search condition when the clock source is turned ON. Select the latch source from CH1 to CH4, M1 to M4, and X. If X is selected, comparison is made every clock. You can select whether to synchronize to the rising or falling edge for making the comparison.

### Setting the Status Determination Level and Hysteresis, the Search Start Point, and the Skip Mode

- **Determination Level of the Status**

You can set the signal level used to determine whether the data pattern is high or low.

- **Setting the Hysteresis**

Sets a width to the detection level so that edges are not detected by small changes.

Selectable range: 0.0 divisions to 4.0 divisions

Resolution: 0.1 division

- **Search Start Point**

You can set the search start point.

Selectable range: -5.00 divisions to 5.00 divisions

Resolution: 0.01 division

- **Selecting the Skip Mode**

You can select the method of skipping the source data during the search.

OFF: Does not skip.

Hold Off: Skips for the specified time.

Selectable range: 0.1 ns to 1.00000 s (six significant digits)

Resolution: 0.1 ns

Decim Time: Skips for the specified search count.

Selectable range: 1 to 9999

### Displaying the Search Result

- Numbers are assigned to the locations where the specified conditions are met. The numbers are assigned in order as follows: 0 for the first match, 1 for the second match, and so on.
- The maximum search number is 4999.
- The waveform at the location of the selected search number can be displayed in the zoom waveform area.

# 10.7 Telecom Testing

## Procedure

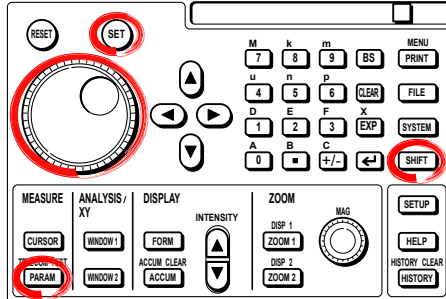

1. Press **SHIFT + PARAM**.

### Selecting the Window to Which the Test Applies

2. Press the **Window** soft key. The Window setting menu appears.
3. Press one of the **Main**, **Zoom1**, and **Zoom2** soft keys, to make the selection.

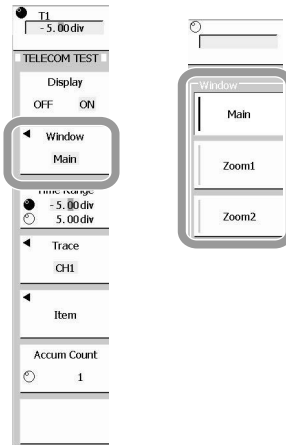

### Selecting the Time Ranges to Which the Test Applies

4. Press the **Time Range** soft key.
5. Turn the **rotary knob**, to set the time range.
6. Repeat steps 4 and 5, to set the time ranges.

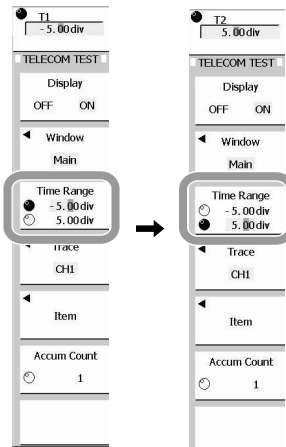

**Selecting the Trace to Which the Test Applies**

7. Press the **Trace** soft key.
8. Press the soft key corresponding to the channel to which the test applies, from CH1 to CH4, and M1 to M4. To select from M1 to M4, press the **M1-M4** soft key to change the selection.

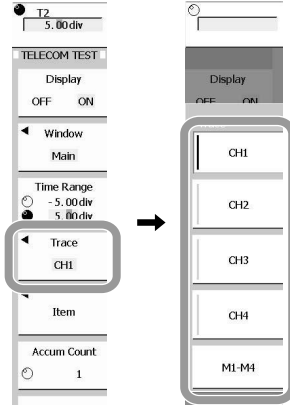

**Selecting the Test Item**

9. Press the **Item** soft key.

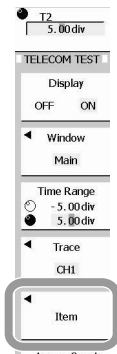

• **Setting the Mask Test Item**

10. Press the **Mask Test** soft key.
11. Turn the **rotary knob**, to select the item to be ON, and press SET. Press SET once more to set the item to OFF.
12. Select the element from Element1 to Element4, and press the corresponding soft key.

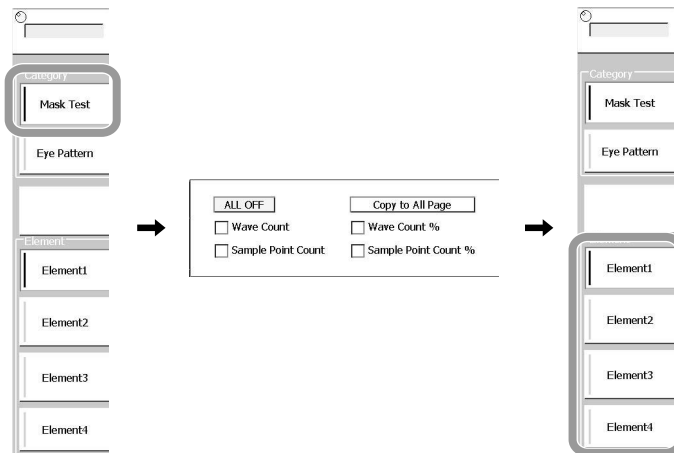

13. Press **ESC** to return to the previous screen.

### Setting the Accumulated Count

14. Press the **Accum Count** soft key.
15. Turn the **rotary knob**, to set the accumulated count.

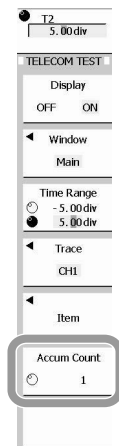

### Explanation

For the four masks (elements) created on a computer, the mask test determines an error if the trace being tested enters the element.

#### Window to which the test applies

Can be selected from Main, Z1, and Z2.

#### Time range to which the test applies

Can be set to a range of  $\pm 5.00$  div.

#### Trace to which the test applies

Can be selected from CH1 to CH4, and M1 to M4.

#### Mask test items

ALL OFF:	Do not display all items.
Copy to All Page:	Copy current settings to all elements.
Wave Count:	Number of errors per acquisition
Sample Point Count:	For the number of sample data values for the element, the number of errors/total number display
Wave Count %:	Error rate against number of acquisitions (%)
Sample Point Count %:	For the number of sample data values for the element, error rate display (%)

#### Notes on the telecom test

- When the telecom test is carried out, waveforms other than the waveform being tested are displayed as follows:
  - If FORM:DotConnect is set to OFF, waveforms are not displayed.
  - If FORM:DotConnect is set to a setting other than OFF, waveforms are displayed in low intensity.
- When GO/NOGO or history search is being carried out. Cannot be done during a mask test.
- When the telecom test is set to ON (open the setting menu), accumulate is also set to ON. The accumulate mode is Count.

#### Note

Because the sample point count is calculated using interpolated data, it may not display a value corresponding to the record length.

# 10.8 Viewing Phase Differences Between Measured Waveforms (XY display)

## Procedure

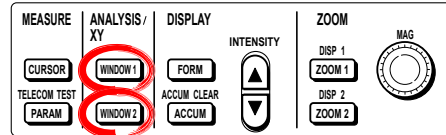

1. Press **WINDOW1** or **WINDOW2**.
2. Press the **Type** soft key.
3. Press the **XY** soft key.

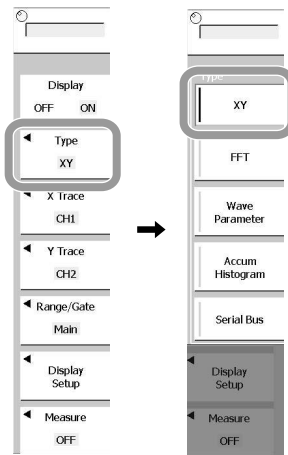

### Setting the X-axis Trace

4. Press the **X Trace** soft key.
5. Select the channel to set the **X Trace**, from CH1 to CH4, and M1 to M4, and press the corresponding soft key. To select from M1 to M4, press the M1-M4 soft key to change the selection.

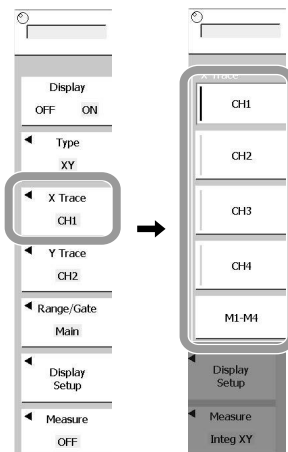

**Setting the Y-axis Trace**

6. Press the **Y Trace** soft key.
7. Select the channel to set the **Y Trace**, from CH1 to CH4, and M1 to M4, and press the corresponding soft key. To select from M1 to M4, press the M1-M4 soft key to change the selection.

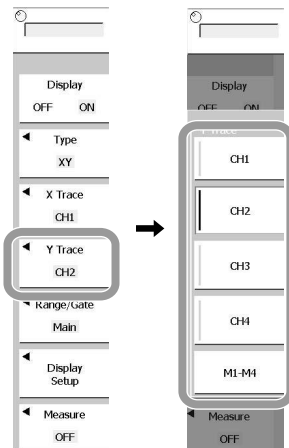

**Setting the Time Axis Range**

8. Press the **Range/Gate** soft key.
9. Select **Main**, **Zoom1**, or **Zoom2**, and press the corresponding soft key.
10. Press the **Time Range** soft key.
11. Turn the **rotary knob**, to set the time range.
12. Repeat steps 10 and 11, to set the time range.
13. Press the **Gate CH** soft key.
14. Select the channel to be set as **Gate CH**, from OFF, CH1 to CH4, and M1 to M4, and press the corresponding soft key. To select from M1 to M4, press the M1-M4 soft key to change the selection. If you select OFF, continue to step 19.
15. Press the **Active Level** soft key, and select H or L.
16. Press the **Level/Hys** soft key.
17. Turn the **rotary knob** to set the level.
18. Repeat steps 16 and 17 to set the threshold values.
19. Press **ESC**.

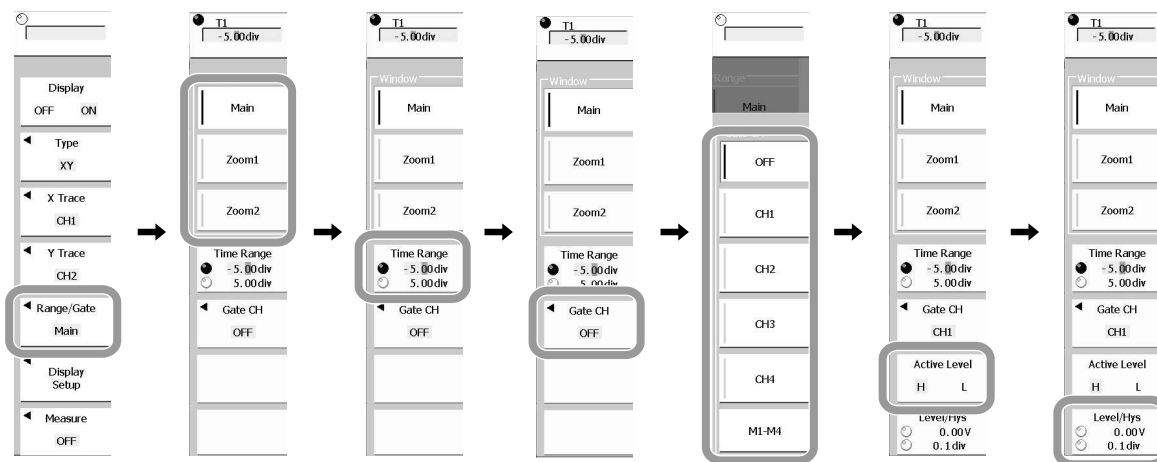

## 10.8 Viewing Phase Differences Between Measured Waveforms (XY display)

### Setting the Display Format

20. Press the **Display Setup** soft key.
21. Press the **VT** soft key to select ON or OFF.
22. Press **ESC**.

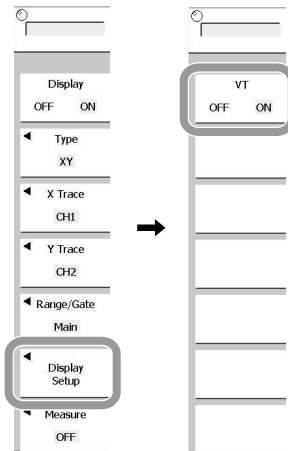

### Setting the Analysis Function

23. Press the **Measure** soft key.
24. Select **OFF**, **Cursor**, or **Integ XY**, and press the corresponding soft key.  
If you select OFF, proceed to step 34.  
If you select Cursor, continue to step 25.  
If you select Integ XY, continue to step 32.

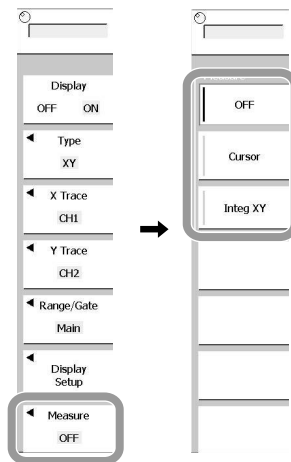

• **Setting the Cursors**

25. Press the **X1/X2** soft key, to assign the rotary knob to X1.
26. With the **rotary knob** or **up and down arrow keys**, move the X1 cursor.
27. Similarly, move the X2 cursor.
28. Press the **Y1/Y2** soft key, to assign the rotary knob to Y1.
29. With the **rotary knob** or **up and down arrow keys**, move the Y1 cursor.
30. Similarly, move the Y2 cursor.
31. Press **ESC**.

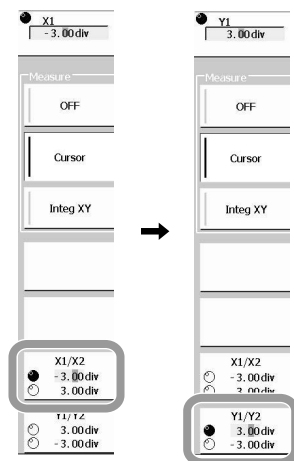

• **Setting Integ XY**

32. Press the **Loop** soft key to select Open or Close.
33. Press the **Polarity** soft key to select CW or CCW.
34. Press **ESC**.

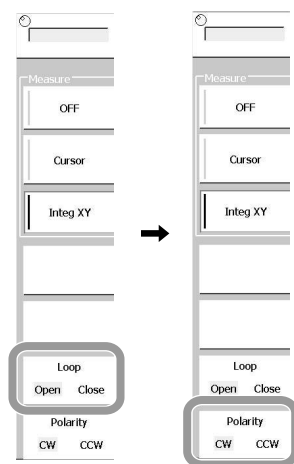



### Explanation

#### X-axis Trace: X Trace

Select from CH1 to CH4, and M1 to M4.

#### Y-axis Trace: Y Trace

Select from CH1 to CH4, and M1 to M4.

#### Setting the Time Axis Range: Range/Gate

Target Window (Window): Select the window for which to set the display range from Main, Zoom1, Zoom2.

Time axis range (Time Range): Specify the range within the selected window.

Selection range:  $\pm 5.00$  div

- **Gate trace: Gate CH**

XY analysis is carried out when the gate trace is above or below the active level. Specify the gate channel.

- **Active level: Active Level**

H: Valid at or above the level

L: Valid at or below the level

- **Level/hysteresis: Level/Hys**

Set the level used to determine the active level, and the hysteresis.

#### Setting the Display Format: Display Setup

Select the VT waveform to be displayed or not displayed.

#### Setting the Analysis Function: Measure

- **OFF**

No analysis carried out.

- **Cursors**

You can simultaneously specify two cursors for each of the X-axis and Y-axis, for a total of four cursors.

X1/X2: Measure the values on the X-axis with the X1 and X2 cursors.  
Setting range  $\pm 4$  div, setting resolution 0.01 div

Y1/Y2: Measure the values on the Y-axis with the Y1 and Y2 cursors.  
Setting range  $\pm 4$  div, setting resolution 0.01 div

- **Integ XY**

Find the sum total of the area of the XY waveform.

Loop: Select the method of finding the area from Open (trapezoid sum total) or Close (triangular sum total).

Polarity: Select the positive direction from CW (clockwise) and CCW (counterclockwise).

For details, see Appendix 2.

# 10.9 Fast Fourier Transform (FFT)

## Procedure

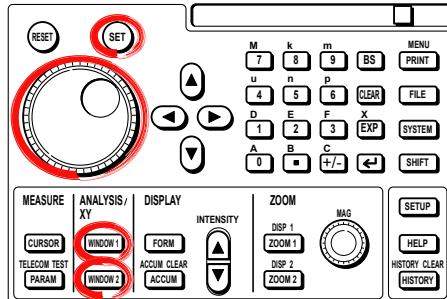

1. Press **WINDOW1** or **WINDOW2**.
2. Press the **Type** soft key.
3. Press the **FFT** soft key.

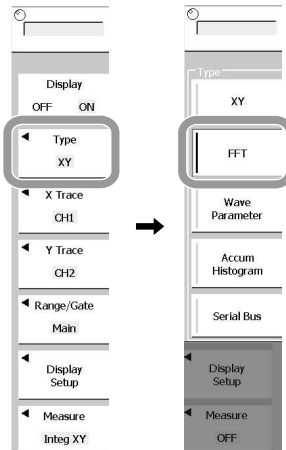

When setting the FFT calculation proceed to step 4, when setting the FFT display proceed to step 15, and when setting the FFT analysis proceed to step 27.

### Setting the FFT calculation

4. Press the **Setup** soft key.

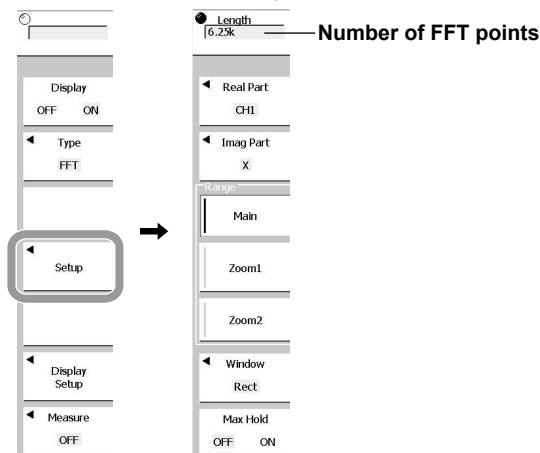

5. With the **rotary knob**, set the number of FFT points.  
Select from 2.5 k, 6.25 k, 12.5 k, 25 k, 62.5 k, 125 k, and 250 k.

**Trace Selection**

6. Press the **Real Part** soft key.
7. Select the channel for Real Part, from CH1 to CH4, and M1 to M4, and press the corresponding soft key. To select from M1 to M4, press the **M1-M4** soft key to change the selection.

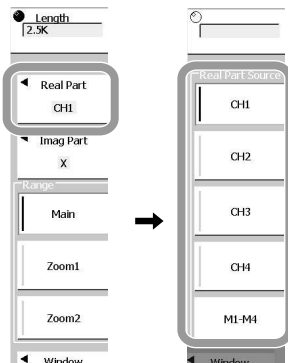

**Selecting the Imaginary Part**

8. Press the **Imag Part** soft key.
9. Select the channel for Imag Part, from CH1 to CH4, M1 to M4, and X, and press the corresponding soft key. To select from M1 to M4, press the **M1-M4** soft key to change the selection.

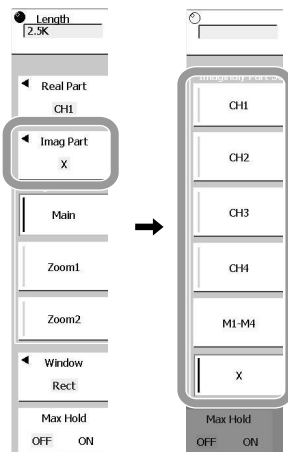

**Selecting the Calculation Range**

10. Select the Main, Zoom1, or Zoom2 window for calculation, and press the corresponding soft key.

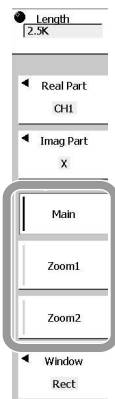

### Selecting the Time Window (Time Window Function)

11. Press the **Window** soft key.
12. Select **Rect**, **Hanning**, or **Flat top**, and press the corresponding soft key.

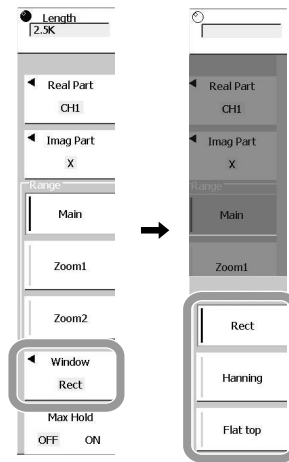

### Setting the Maximum Value Hold

13. Press the **Max Hold** soft key to select ON or OFF.
14. Press **ESC**. This returns to the original menu.

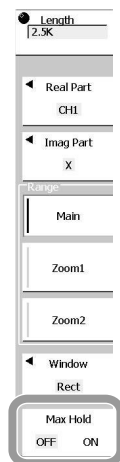

**Setting the Display Format**

15. Press the **Display Setup** soft key.
16. Press the **VT** soft key, to select ON (display time axis waveforms) or OFF (do not display time axis waveforms).

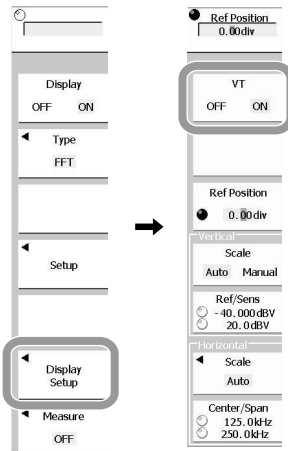

• **Setting the Reference Position**

17. Press the **Ref Position** soft key.
18. With the **rotary knob**, set the range.

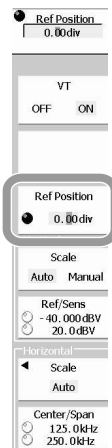

• **Setting the Vertical Axis Display**

19. Press the **Scale (Vertical)** soft key, and select Auto or Manual.
20. Press the **Ref/Sens (Vertical)** soft key.
21. With the **rotary knob**, set Ref Level (level at the center of enlargement) and Sens (sensitivity).  
When Scale is Default, changing the Ref/Sens setting switches the Scale to Manual.

- **Setting the Horizontal Axis Display**
  22. Press the **Scale (Horizontal)** soft key.
  23. Select **Auto**, **Center/Span**, or **Left/Right**, and press the corresponding soft key.
  24. Press the **Center/Span** soft key (Left/Right when Scale is Left/Right).
  25. With the **rotary knob**, set the Center and Span (display range width).  
When Scale is set to Left/Right, set Left and Right.
  26. Press **ESC**. This returns to the original menu.

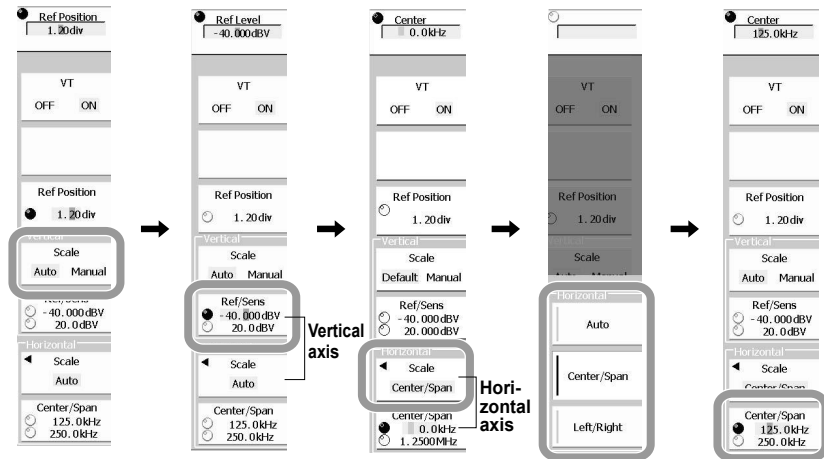

### Setting the Analysis Function

27. Press the **Measure** soft key.
28. Select **OFF**, **Marker**, or **Peak**, and press the corresponding soft key.

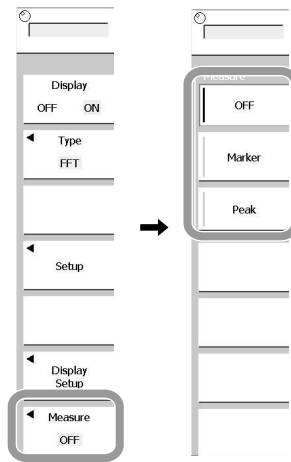

- **Setting the Computation Item**

(Set the item when Marker or Peak is selected in step 28 on page 10-46.)

29. Press the **Item** soft key.
30. Press the **Basic** soft key.
31. Turn the **rotary knob** to select the item to be turned ON, and press **SET**. Press SET again to turn the item OFF.  
(Of the choices, F(F1), F(F2), and  $\Delta F$  can be used on products with firmware version 1.80 or later.)
32. To calculate using FFT analysis values, press the **Calc** soft key.
33. Turn the **rotary knob** to select the equation number to be turned ON. Press **SET** to select the check box.
34. Select the equation area, press **SET**, and enter the equation.  
(Operator buttons F(F1), F(F2), and  $\Delta F$  can be used on products with firmware version 1.80 or later.)
35. Press **ESC** to return to the analysis function setting screen.

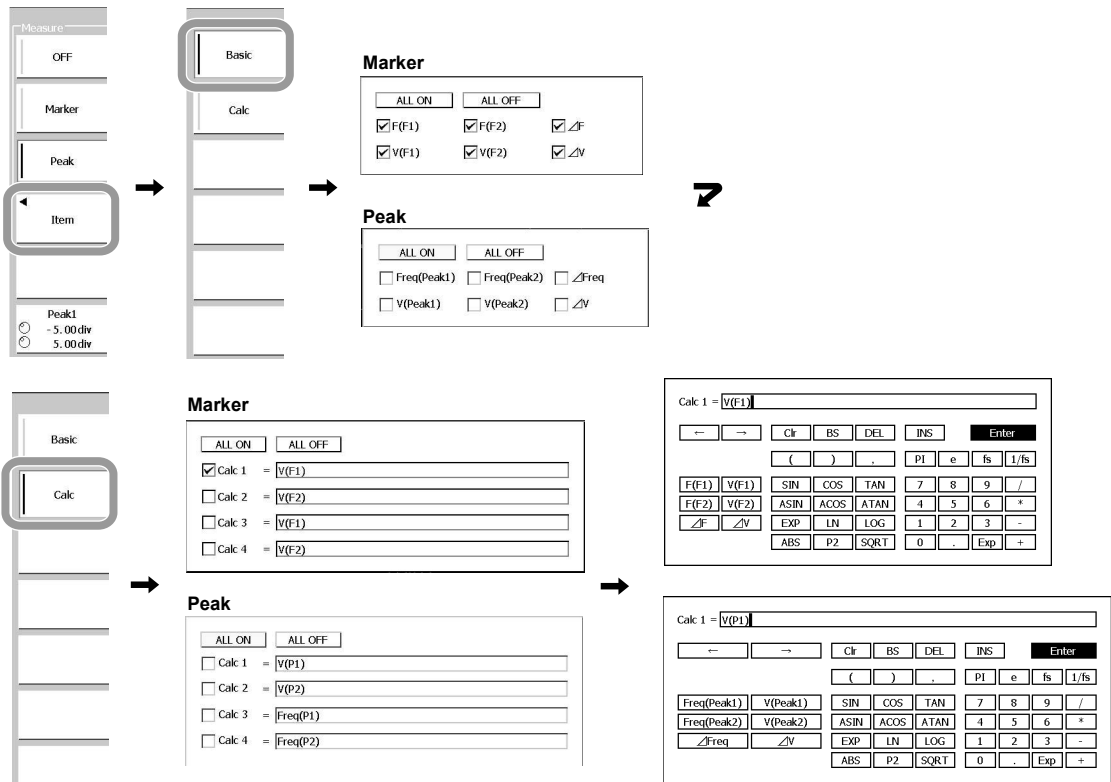

• **Moving the Cursor (When set the Measure to Marker)**

36. Press the **F1 Position** soft key.
37. Turn the **rotary knob** to move the F1 cursor.
38. Press the **F2 Position** soft key.
39. Turn the **rotary knob** to move the F2 cursor.
40. Press **ESC**. This returns to the FFT analysis setting screen.

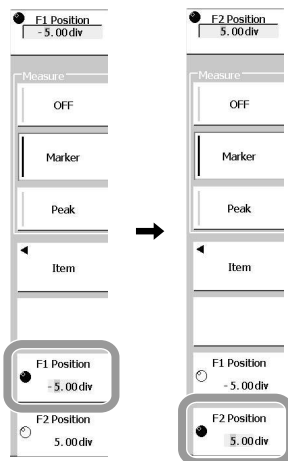



## 10.9 Fast Fourier Transform (FFT)

- **Setting the Peak Range (When set the Measure to Peak)**

41. Press the **Peak1** soft key.
42. With the **rotary knob**, set the Peak1 start point and end point.
43. Press the **Peak2** soft key.
44. Turn the **rotary knob**, to set the Peak2 start point and end point.
45. Press **ESC**. This returns to the FFT analysis setting screen.

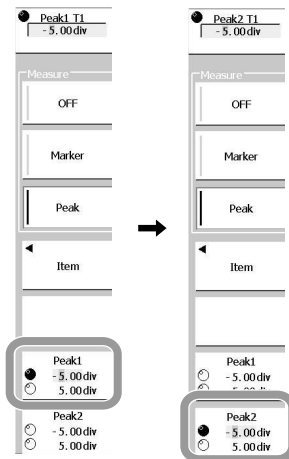

### Explanation

#### Number of FFT points

Can be selected from 2.5k, 6.25k, 12.5k, 25k, 62.5k, 125k, and 250k.

#### Trace Selection: Real Part

Select from CH1 to CH4, and M1 to M4.

#### Imaginary Part Selection: Imag Part

Select from CH1 to CH4, M1 to M4, and X.

#### Calculation Range Selection: Range

Select the range for FFT calculation, from Main, Zoom1, and Zoom2.

#### Setting the Time Window: Window

Select the time window for FFT calculation.

Rect: Rectangular

Hanning: Hanning

Flat top: Flat top

#### Maximum Value: Max Hold

Select whether or not to hold and display the maximum value of the various frequencies from the start of calculation to the present.

#### Setting the Display Format: Display Setup

- **VT**

Select whether to display or not display the VT waveform.

- **Ref Position**

Set the reference position on the vertical axis.

Setting range  $\pm 4$  div

- **Setting the Vertical Axis: Vertical**

Default: Set the predetermined axis.

Manual: Select when the axis is set by the user.

- **Setting the Horizontal Axis: Horizontal**

Default: Set the predetermined center point and span.

Center/Span: Select this when the horizontal axis has the center value and span set to arbitrary values.

Left /Right: Select this when the horizontal axis has the left and right ends set to arbitrary values.

**Setting the Measure Item**

- **OFF**

Does not perform the analysis.

- **Marker**

Set the positions of the two markers (F1: Xmarker and F2: +marker). The FFT values (frequency and level) at the markers and the difference between the markers are computed.

- FFT frequency value: F(F1), F(F2)
- FFT level value: V(F1), V(F2)
- Difference between markers:  $\Delta F$  = Difference between F(F1) and F(F2)  
 $\Delta V$  = Difference between V(F1) and V(F2)

- F1 Position and F2 Position: Sets each marker position.

- Selectable range:  $\pm 5.00$  div

\* F (F1), F (F2), and  $\Delta F$  can be used on products with firmware version 1.80 or later.

- **Peak**

Set two ranges along the frequency axis (horizontal axis). The peak values (P1 and P2) of the FFT values (frequency and level) in the two ranges and the difference between the peaks are calculated.

- FFT frequency value: Freq(Peak1), Freq(Peak2)
- FFT level value: V(Peak1), V(Peak2)
- Difference between the peaks:  
 $\Delta Freq$  = Difference between Freq(Peak1) and Freq(Peak2)  
 $\Delta V$  = Difference between V(Peak1) and V(Peak2)

- Peak1/Peak2: Sets each range.

- Selectable range:  $\pm 5.00$  div

Table of selectable computation items and the corresponding names used to display the computed results

Selectable Computation Items	Names Used to Display the Computed Results	
<b>Marker</b>		
FFT frequency value	F(F1)	F1
	F(F2)	F2
FFT level value	V(F1)	V1
	V(F2)	V2
Difference between markers:	$\Delta F$	$\Delta F$
	$\Delta V$	$\Delta V$
<b>Peak</b>		
FFT frequency value	Freq(Peak1)	Freq(P1)
	Freq(Peak2)	Freq(P2)
FFT level value	V(Peak1)	V(P1)
	V(Peak2)	V(P2)
Difference between the peaks:	$\Delta Freq$	$\Delta Peak(Hz)$
	$\Delta V$	$\Delta Peak(V)$

# 10.10 Displaying Graphs and Lists of Automatic Measurement Waveform Parameters

## Procedure

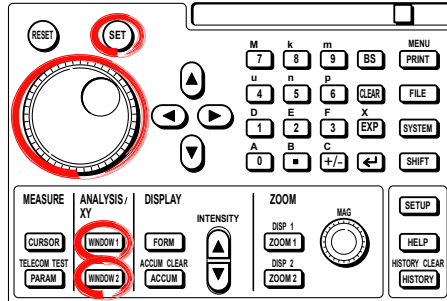

1. Press **WINDOW1** or **WINDOW2**.
2. Press the **Type** soft key.
3. Press the **Wave Parameter** soft key.

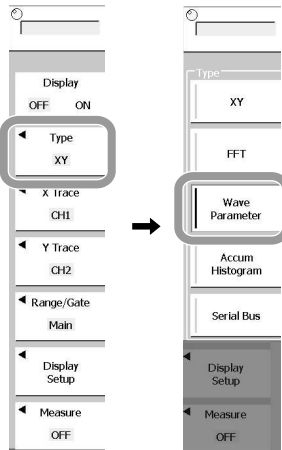

## Histogram Display

### Selecting the Histogram

4. Press the **Mode** soft key.
5. Press the **Histogram** soft key.

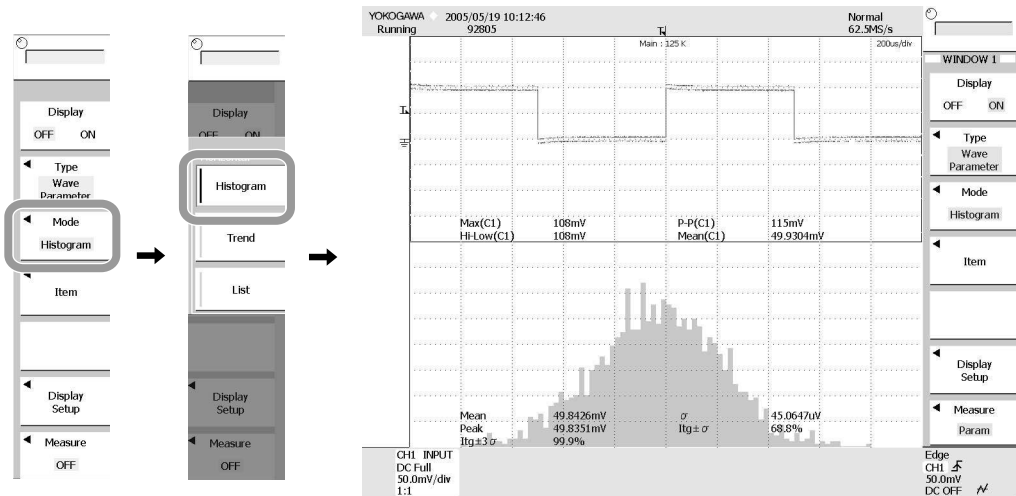

### Setting Display Items

1. Press the **Item** soft key.

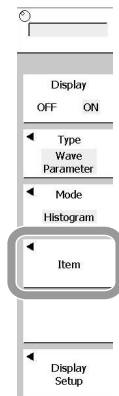

- **Selecting the Area/Trace**

2. Press the **Area** soft key to select Area1 or Area2.  
 Another selection menu appears on products with firmware version 3.6 or later. Select Area1 or Area2 on that menu.  
 When the waveform parameter mode is Cycle Statistics (see Section 10.3), the Area setting is not possible.
3. Press the soft key corresponding to the waveform to be measured to set the source waveform.

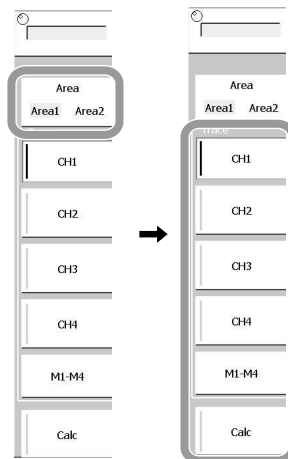

- **Selecting the Item**

4. With the **rotary knob**, select the item to be set, and press **SET**. Only one item can be selected.

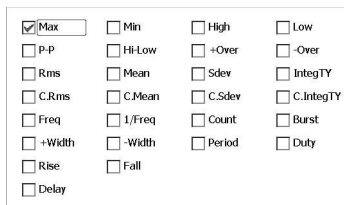

## 10.10 Displaying Graphs and Lists of Automatic Measurement Waveform Parameters

- **Setting the Calculation**

5. To display a calculation result from waveform parameters as a histogram, press the **Calc** soft key.  
On products with firmware version 3.6 or later, pressing the **Area** soft key displays a selection menu. Press the **Calc** soft key on this menu.
6. With the **rotary knob**, select the equation and press **SET**. Select the equation from the equations set for automatic measurement of waveform parameters.
7. Press **ESC**.

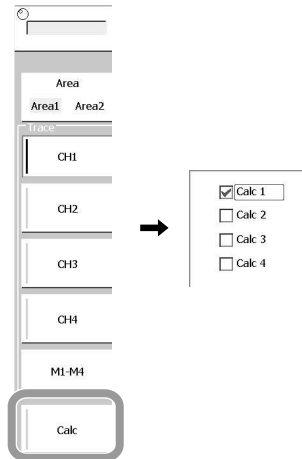

### Setting the Display Format

8. Press the **Display Setup** soft key.
9. Press the **VT** soft key to select ON or OFF. When set to ON, in the upper half of the screen the normal voltage/time-axis display waveform appears.
10. Press **ESC**.

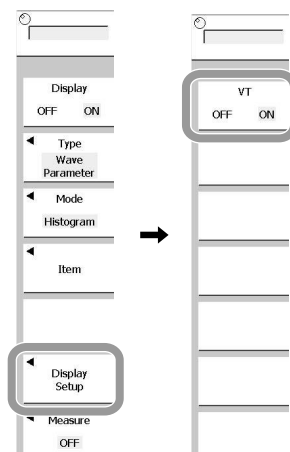

**Setting the Analysis Function**

11. Press the **Measure** soft key. A menu used to set whether to display the waveform parameters appears.
12. Press **OFF**, **Cursor**, or **Param** soft key to select the data source.  
If you select OFF, proceed to step 16.  
If you select Cursor or Param, proceed to step 13.  
(The Cursor setting can be used on products with firmware version 1.80 or later.)

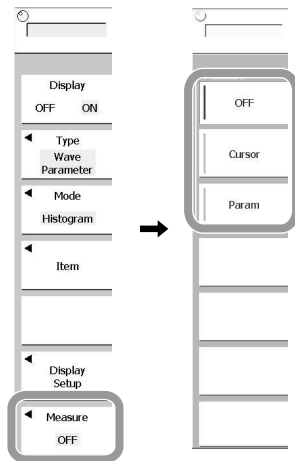

• **Selecting the Measurement Item**

13. Press the **Item** soft key.
14. Turn the **rotary knob** to select the item to be displayed, and press SET. The check box is selected.  
Press SET again to turn the item OFF.
15. Press **ESC** to return to the analysis function setting screen.
16. Press **ESC** to return to the Wave Parameter setting screen.

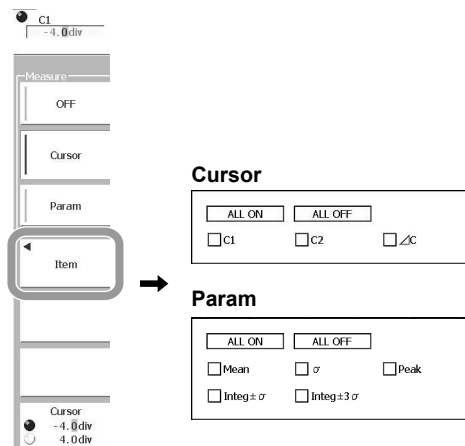

## Trend Display

### Selecting the Trend

17. Press the **Mode** soft key.
18. Press the **Trend** soft key.

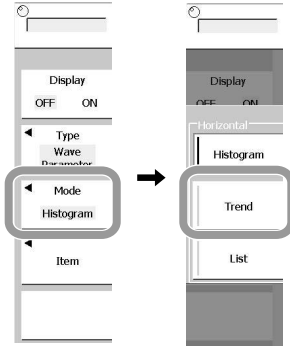

### Selecting the Display Item

19. Press the **Item** soft key.

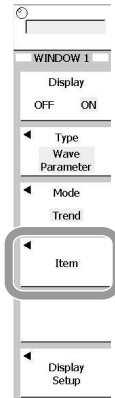

- **Selecting the Trace**

20. Press the soft key **Area**, to select Area1 or Area2.

Another selection menu appears on products with firmware version 3.6 or later. Select Area1 or Area2 on that menu.

When the waveform parameter mode is Cycle Statistics (see Section 10.3) Area cannot be set.

21. Press the soft key corresponding to the waveform to be measured to set the source waveform.

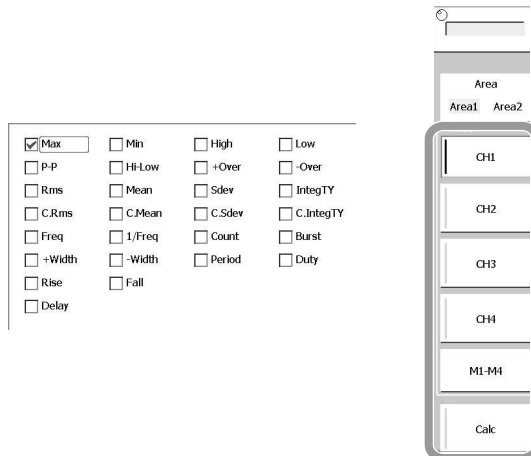

## 10.10 Displaying Graphs and Lists of Automatic Measurement Waveform Parameters

- **Selecting the Item**

22. With the **rotary knob**, select the item to be set, and press **SET**. Only one item can be selected.

**Note**

Only one item can be selected.

### Setting the Calculation

23. To display a calculation result from waveform parameters as a histogram, press the **Calc** soft key.
 

On products with firmware version 3.6 or later, pressing the **Area** soft key displays a selection menu. Press the **Calc** soft key on this menu.
24. With the **rotary knob**, select the equation, and press **SET**. Select the equation from the equations set for automatic measurement of waveform parameters.
25. Press **ESC**.

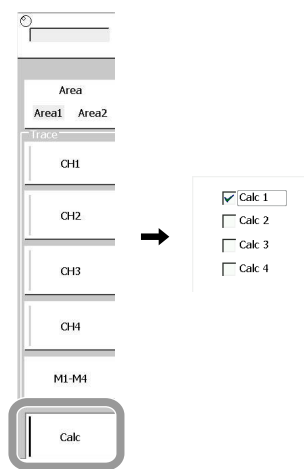

### Setting the Display Format

26. Press the **Display Setup** soft key.
27. Press the **VT** soft key to select ON or OFF. When set to ON, in the upper half of the screen the normal voltage/time-axis display waveform appears.
 

Set the display range.

Press the **Auto Scale EXEC** soft key to automatically set the display range.
28. Press the **Upper/Lower** soft key.
29. With the **rotary knob**, set Upper (upper limit) and Lower (lower limit).
30. Press the **H Span** soft key.
31. With the **rotary knob**, set the horizontal axis range.

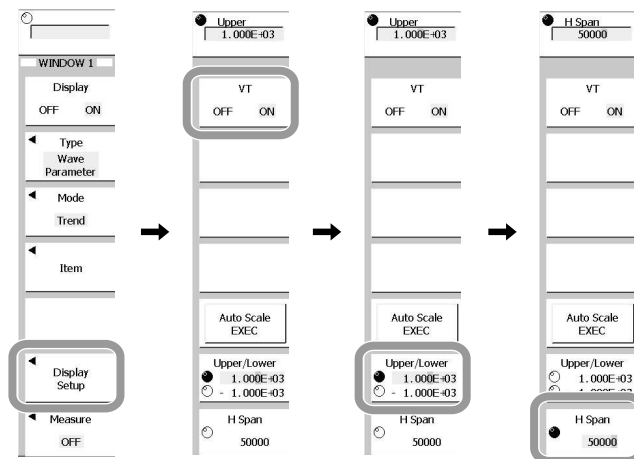



**Setting the Analysis Function**

32. Press the **Measure** soft key.
33. Select **OFF** or **Cursor**, and press the corresponding soft key.  
If you select OFF, proceed to step 37.  
If you select Cursor, continue to step 34.

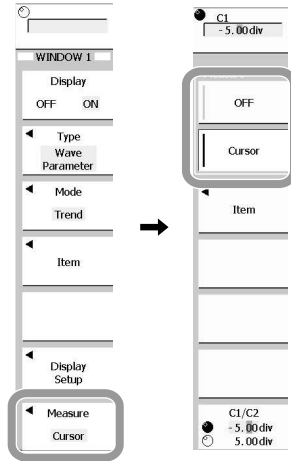

• **Selecting the Measurement Item**

34. Press the **Item** soft key.
35. Turn the **rotary knob** to select the item to be ON, and press **SET**.  
Press **SET** once more, to set the item to OFF.

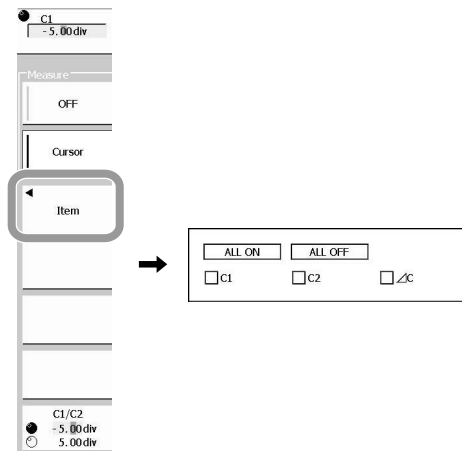

36. Press **ESC**. This returns to the analysis function setting screen.

## 10.10 Displaying Graphs and Lists of Automatic Measurement Waveform Parameters

- **Moving the Cursors**

37. Press the **C1/C2** soft key.
38. With the **rotary knob**, move the cursor to C1 or C2.



39. Press **ESC**. This returns to the Wave Parameter setting screen.

## List Display

### Selecting the List

40. Press the **Mode** soft key.
41. Press the **List** soft key.

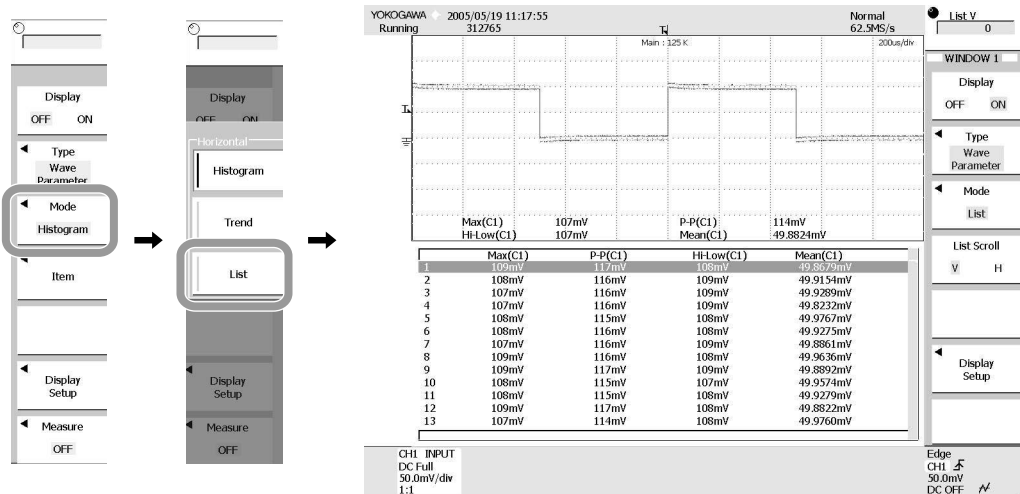

## 10.10 Displaying Graphs and Lists of Automatic Measurement Waveform Parameters

### Setting the List Scrolling Direction

42. Press the **Scroll (List Scroll)** on products with firmware version before 1.60) soft key to select V (vertical direction) or H (horizontal direction).
- **V (vertical direction):** You can scroll the list vertically using the **rotary knob** or the **up and down** arrow keys. You can also specify the list number directly using List V at the top of the menu. List numbers cannot be specified directly for products with firmware version 1.60 or later.
  - **H (horizontal direction):** You can scroll the list horizontally using the **rotary knob** or the **up and down** arrow keys.
  - On products with firmware version 1.60 or later, you can press the Setup soft key and select the scroll amount from **1, 10, 100, 1000, and 10000**.
    - \* The same V Scroll Weight menu appears regardless of whether you select H or V with the Scroll soft key. Select the scroll amount on the menu.

### Selecting the Trend List or Statistic List

(This function can be used on products with firmware version 3.20 or later.)

43. Press the **Mode** soft key to select Trend or Statistic.

Menu on products with firmware version 1.60 or later

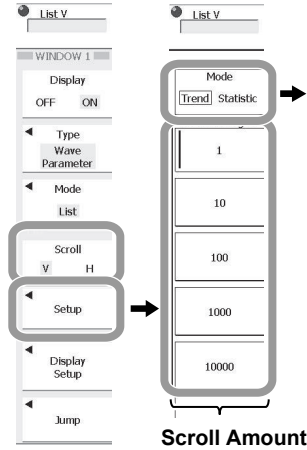
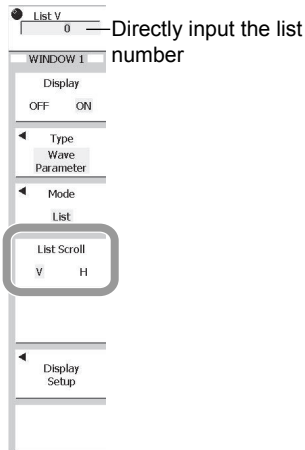

Selecting the Trend List or Statistic List (This function can be used on products with firmware version 3.20 or later.)

For Trend

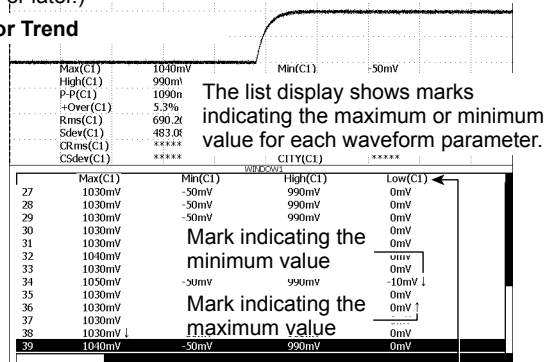

Measurement count

Waveform parameters (measurement items)

For Statistic

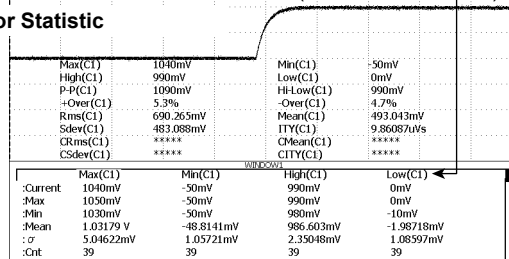

Statistical items

- **Current:** Measured values of the waveform displayed currently if the waveform parameter mode is set to Basic or Continuous Statistics
  - Measured values of the last waveform if the waveform parameter mode is set to History Statistics or Cycle Statistics
- Max: Maximum value  
 Min: Minimum value  
 Mean: Average value  
 $\sigma$ : Standard deviation  
 Cnt: Number of measured values used in the statistical processing

**Setting the Display Format**

44. Press the **Display Setup** soft key.
45. Press the **VT** soft key to select ON or OFF. If ON is specified, the waveform is displayed on a normal voltage-time axis.
46. Press **ESC**.

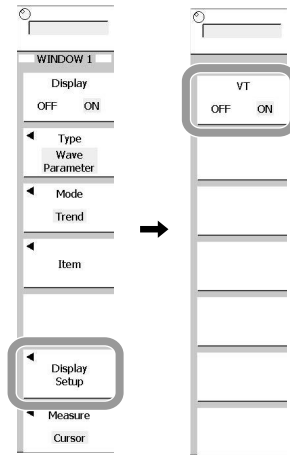

**Jumping to the Maximum or Minimum Value among the Selected Items or the Latest or Oldest Data in the List**

(This function can be used on products with firmware version 1.60 or later.)

47. Press the **Jump** soft key to display the Jump menu.
  - The same Jump menu appears regardless of whether you select H or V with the Scroll soft key.
48. Select the **Latest**, **Oldest**, **Max**, or **Min** soft key to select the jump destination.
  - The display jumps to the selected data.
  - Latest: The latest data in the list
  - Oldest: The oldest data in the list
  - Max: The maximum value among the selected items
  - Min: The minimum value among the selected items

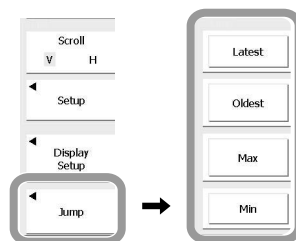

**Explanation**

**Selecting the Method of Graph Display: Mode**

Histogram	Show results as a histogram display.
Trend	Show results as a trend display.
List	Show results as a list. All items selected for automatic measurement of waveform parameters appear.

**Selecting the Display Item: Item**

Select the channels for which the items are displayed, and the items to display.

**Setting the Display Format: Display Setup**

- Switch the VT waveform display on or off.
- H-Span  
Set this for a trend display. From the latest measurement result, the specified number of data values are shown in a trend display. The maximum value is 100000/(number of items selected).

**Setting the Analysis Function: Measure**

- **OFF**  
No analysis carried out.
- **Param**  
The item parameters can be set.

Mean	Average value
$\sigma$	Standard deviation of histogram
Peak	Peak value of histogram
Integ $\pm\sigma$	Proportion within one standard deviation (%)
Integ $\pm 3\sigma$	Proportion within three standard deviations (%)

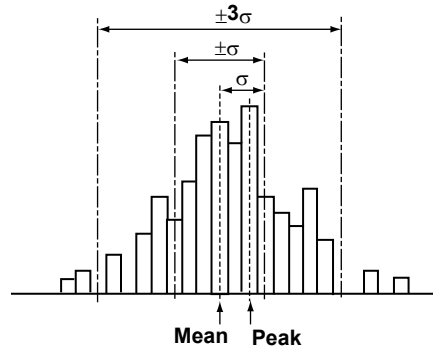

• **Cursor(Histogram, Trend)**

C1	Show cursor C1 measurement value
C2	Show cursor C2 measurement value
$\Delta C$	Difference between the measured values of cursors C1 and C2

On the histogram display, the Cursor setting can be used on products with firmware version 1.80 or later.

**Display range (trend)**

When the Mode is Trend, carrying out Auto Scale results in Upper/Lower and H-Span settings as follows.

Upper/Lower	Set so that the difference between waveform parameter Max and Min is 80% of the waveform area.
H-Span	Set so that the waveform parameters measured before carrying out Auto Scale are all displayed. When the Mode for automatic measurement of waveform parameters is Basic or Continuous Statistics, if the number of measured waveform parameters is 100 or less it is set to 100.

# 10.11 Displaying Frequency Distribution for a Specified Area (Accum Histogram)

## Procedure

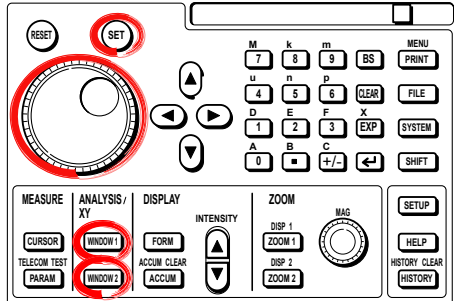

1. Press **WINDOW1** or **WINDOW2**.
2. Press the **Type** soft key.
3. Press the **Accum Histogram** soft key.

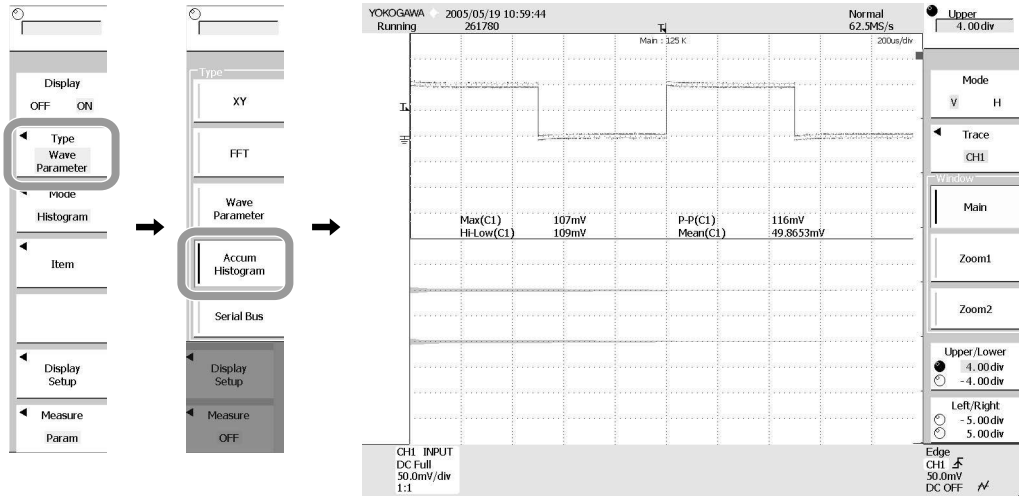

### Setting the Item

4. Press the **Setup** soft key.

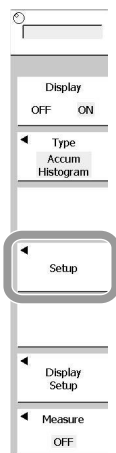

## 10.11 Displaying Frequency Distribution for a Specified Area (Accum Histogram)

- **Selecting the Axis**

5. Press the **Mode** soft key to select V or H. When set to V, a histogram on the Y-axis is display. When set to H, a histogram on the X-axis is displayed.

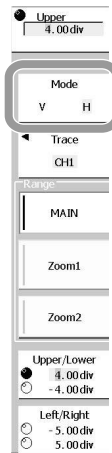

- **Selecting the Trace for Analysis**

6. Press the **Trace** soft key.
7. Select the channel for the trace, from CH1 to CH4, and M1 to M4, and press the corresponding soft key. To select from M1 to M4, press the **M1-M4** soft key to change the selection.

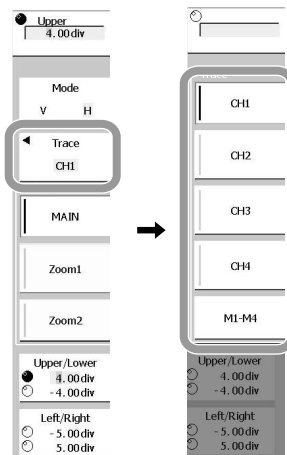

- **Setting the Window for the Range**

8. Select Window from **Main**, **Zoom1**, and **Zoom2**, and press the corresponding soft key.

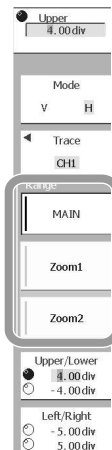

## 10.11 Displaying Frequency Distribution for a Specified Area (Accum Histogram)

- **Setting the Upper and Lower Limits**

9. Press the **Upper/Lower** soft key.
10. With the **rotary knob**, set the upper limit and lower limit.

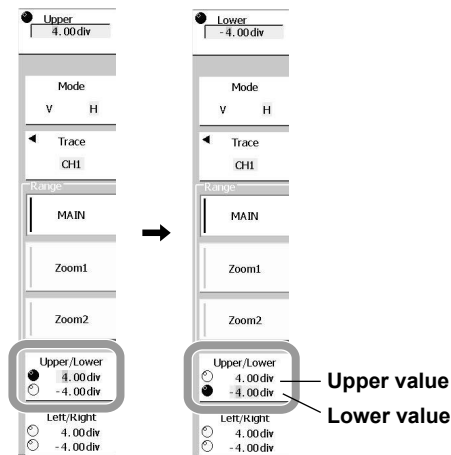

- **Setting the Left and Right End Values**

11. Press the **Left/Right** soft key.
12. With the **rotary knob**, set the left and right end values.
13. Press **ESC**.

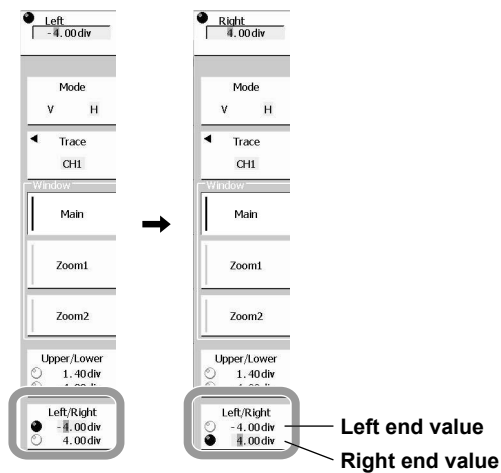



## 10.11 Displaying Frequency Distribution for a Specified Area (Accum Histogram)

### Setting the Display Format

14. Press the **Display Setup** soft key.
15. Press the **VT** soft key to select ON or OFF. When set to ON, in the upper half of the screen the normal voltage/time-axis display waveform appears.
16. Press **ESC**.

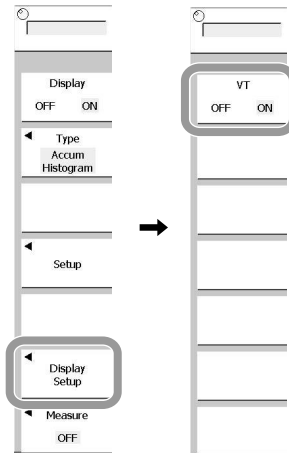

### Setting the Analysis Function

17. Press the **Measure** soft key.
18. Select **OFF**, **Cursor**, or **Param**, and press the corresponding soft key.  
If you select OFF, proceed to step 44.  
If you select Cursor, continue to step 19.  
If you select Param, proceed to step 31.

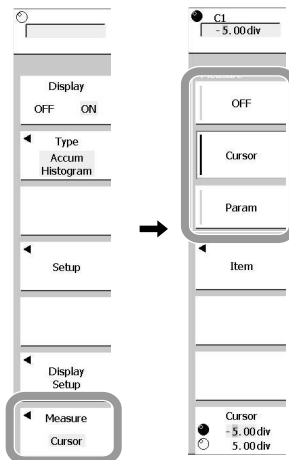

Setting the Cursors

• **Selecting the Cursor Measurement Items**

19. Press the **Item** soft key.
20. Press the **Basic** soft key.
21. Turn the **rotary knob** to select the item to be ON, and press **SET**. This adds a check mark.  
Press SET once more, to set the item to OFF.

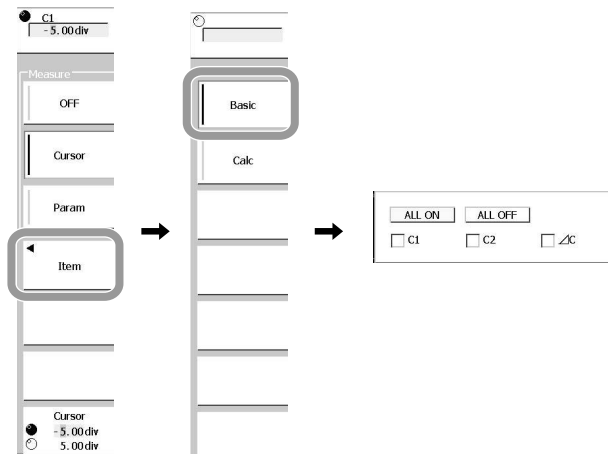

• **Setting the Cursor Calculation (When Calculating Using Cursor Measurement Values)**

22. Press the **Calc** soft key.
23. Turn the **rotary knob** to select the calculation number, and press SET. This adds a check mark.
24. With the **rotary knob**, select the equation area, press SET, and enter the equation.
25. When the input is completed, press **ENTER** to confirm the equation.
26. Press **ESC**.

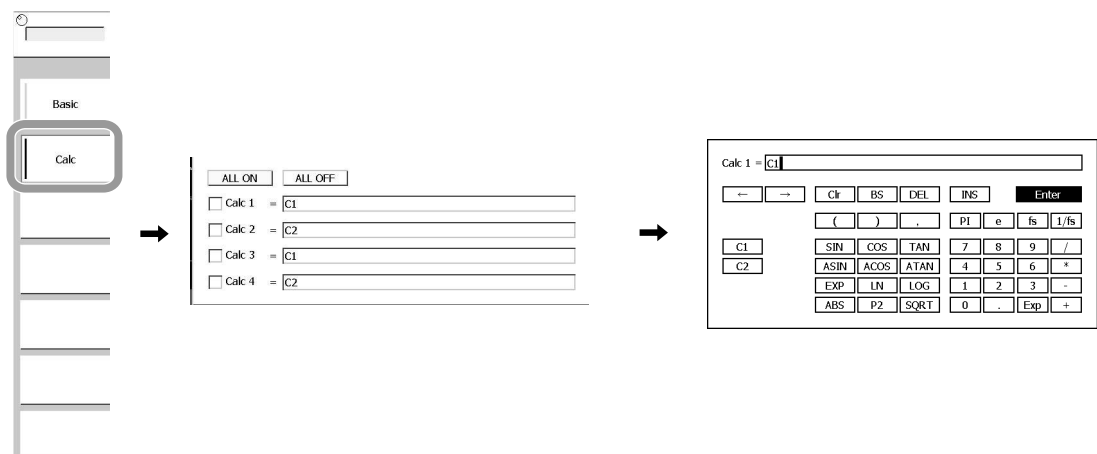

## 10.11 Displaying Frequency Distribution for a Specified Area (Accum Histogram)

- **Setting the Cursor Positions**

27. Press the **Cursor** soft key.
28. Turn the **rotary knob** to set the cursor position.
29. Repeat steps 27 to 28 to set the cursor positions.

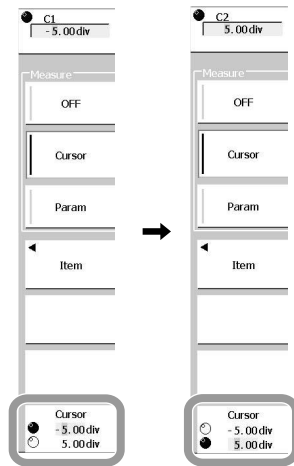

30. Press **ESC**.

### Setting the Parameter Analysis

- **Setting the Parameter Analysis Items**

31. Press the **Item** soft key.
32. Select the area for setting the item, from Area1 and Area2, and press the corresponding soft key.
33. Turn the **rotary knob**, to select the item to be ON, and press **SET**. This adds a check mark.  
Press **SET** once more, to set the item to OFF.

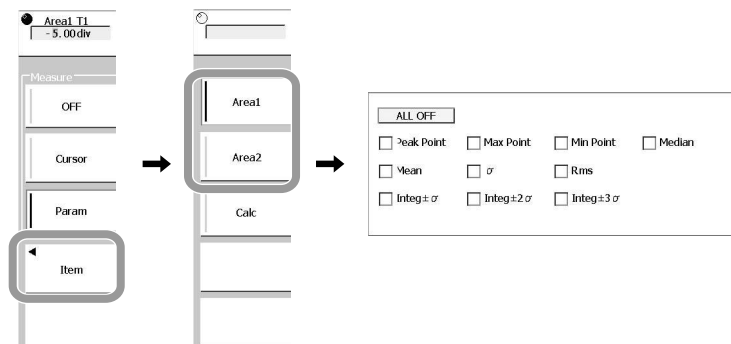

## 10.11 Displaying Frequency Distribution for a Specified Area (Accum Histogram)

### • Setting the Calculation

34. Press the **Calc** soft key.
35. Turn the **rotary knob** to select the calculation number, and press **SET**. This adds a check mark.
36. With the **rotary knob**, select the equation area, press **SET**, and enter the equation.
37. When the input is completed, press **ENTER** to confirm the equation.
38. Press **ESC**.

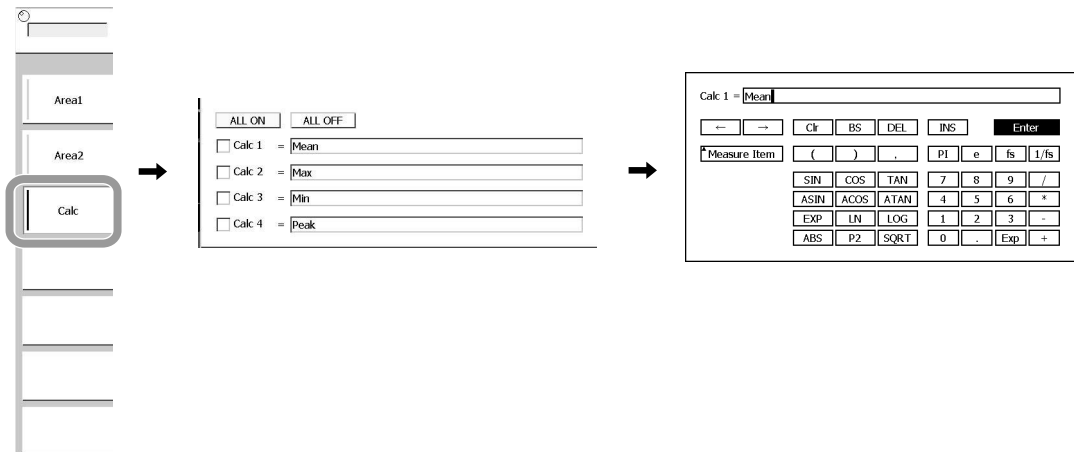

### • Setting the Area

39. Press the **Area1** soft key.
40. Turn the **rotary knob**, to set the Area1 range.
41. Repeat steps 39 and 40 to set the Area1 ranges.
42. Press the **Area2** soft key.
43. Turn the **rotary knob**, to set the Area2 range.
44. Repeat steps 42 and 43 to set the Area2 ranges.
45. Press **ESC**.

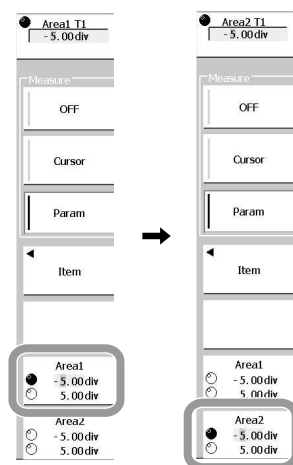

**Explanation**

**Axis Selection: Mode**

Select the axis for taking a histogram.

V: Vertical axis

H: Horizontal axis

**Trace for Analysis: Trace**

Select from CH1 to CH4, and M1 to M4.

**Window Range: Window**

Select the window for analysis, from Main, Zoom1, and Zoom2.

- **Upper/Lower**  
Set the range on the X-axis to specify the box for the area to generate the histogram.  
Setting range  $\pm 4$  div
- **Left/Right**  
Set the range on the Y-axis to specify the box for the area to generate the histogram.  
Setting range  $\pm 4$  div

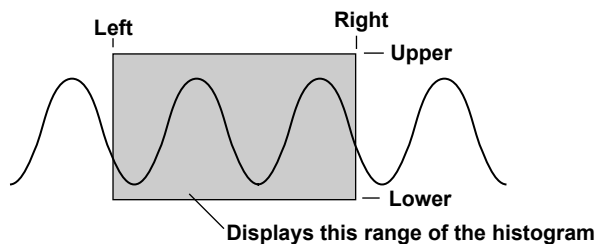

**Setting the Display Format: Display Setup**

Switch the VT waveform display on or off.

**Setting the Analysis Function: Measure**

- **OFF**  
No analysis carried out.
- **Cursor**  
When the Mode is H, set the two vertical cursors, and measure the Y-axis values at the cursor positions.  
When the Mode is V, set the two horizontal cursors, and measure the X-axis values at the cursor positions.

## 10.11 Displaying Frequency Distribution for a Specified Area (Accum Histogram)

- **Param**

The item parameters can be set.

Peak: Peak value

Max Point: Maximum value

Min Point: Minimum value

Median: Median value\*

Mean: Average value

$\sigma$ : Standard deviation of histogram

Rms: Effective value

Integ  $\pm\sigma$ : Proportion within one standard deviation (%)

Integ  $\pm 2\sigma$ : Proportion within two standard deviations (%)

Integ  $\pm 3\sigma$ : Proportion within three standard deviations (%)

\* The value of the sample that is midway between the minimum and the maximum (counting from the minimum) when the samples are arranged in sequence from minimum to maximum.

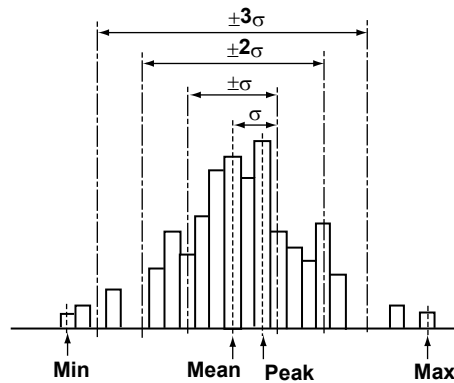

## 10.12 Automated Measurement of Waveform Parameters of Eye Patterns

This function can be used on products with firmware version 1.60 or later.

### Procedure

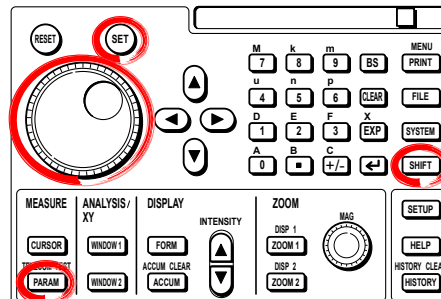

1. Press **SHIFT + PARAM**.

### Selecting the Measured Items of Eye Patterns

2. Press the **Item** soft key to display the Category menu.
3. Press the **Eye Pattern** soft key.
4. Turn the **rotary knob** to select the item to be turned ON, and press **SET**. Press **SET** again to turn the item OFF.

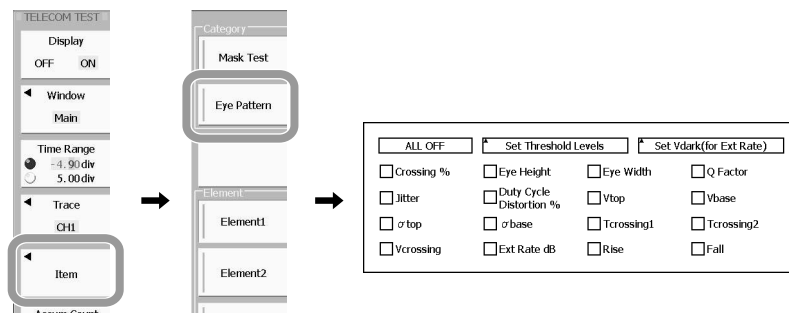

### Setting the Threshold Level

5. Turn the **rotary knob** to select Set Threshold Levels, and press **SET**. The Thresh Levels menu appears.
6. Press the **%/V** soft key to set the unit of the threshold level to % or V.
  - %: Set the level in the range of 0 to 100% in step 8 and 10. The difference between Vtop and Vbase is taken to be 100%.
  - V: Set the level in the range of  $\pm 10$  divisions in step 8 and 10. The unit varies depending on the specified conditions.
7. Press the **Upper** soft key.
8. Turn the **rotary knob** to set the high voltage threshold level.
9. Press the **Lower** soft key.
10. Turn the **rotary knob** to set the low voltage threshold level.

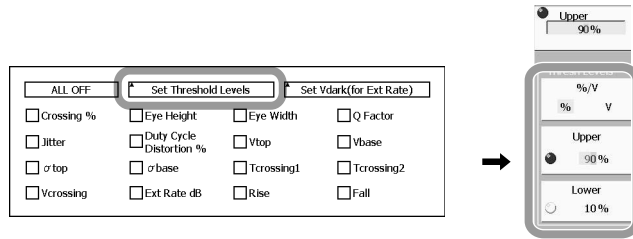

11. Press **ESC** to return to the previous screen.

### Setting the Dark Level

12. Turn the **rotary knob** to select Set Vdark (for Ext Rate), and press **SET**.
13. Turn the **rotary knob** to set the dark level (zero light level).
14. Press **ESC** to return to the previous screen

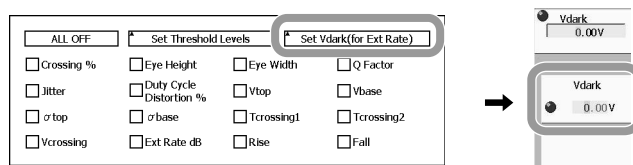

### Explanation

You can select the automated measurement parameters of the eye pattern waveform and display the measured results. For the procedure to set the window, time range, trace, and accumulation count, see section 10.7.

### Measurement Item

There are 16 measurement items. For the definition and computing equation of each item, see section 2.8.

### Setting the Threshold Level (High Level and Low Level)

You can set the threshold as a percentage or a physical value. The threshold level is applied when measuring the Rise (time for the signal to change from lower level to upper level) and the Fall (time for the signal to change from upper level to lower level) items of eye pattern measurement.

?: The level can be set in the range between 0 to 100%. The difference between Vtop and Vbase is taken to be 100%.

V: The level can be set in the range between  $\pm 10$  divisions. The unit varies depending on the specified conditions.

### Setting the Dark Level

You can set the dark level (zero light level). The dark level is applied when measuring the Ext Rate dB (extinction rate dB) item in eye pattern measurement.

The level can be set in the range between  $\pm 10$  divisions. The unit varies depending on the specified conditions.



# 11.1 Displaying History Waveforms

## Procedure

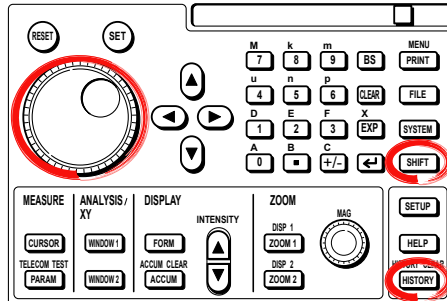

1. Press **HISTORY**.  
If you press HISTORY during waveform acquisition, waveform acquisition stops.

### Setting the History Waveform To Be Displayed

2. Press the **Start/End** soft key and use the rotary knob to select either Start or End.
3. With the **rotary knob**, select the record number of the first history waveform to be displayed, or the last record number.

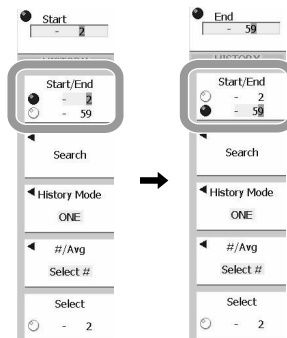

**Selecting the Display Mode**

4. Press the **History Mode** soft key.
5. Press the soft key corresponding to the display mode for the history waveform to be set.

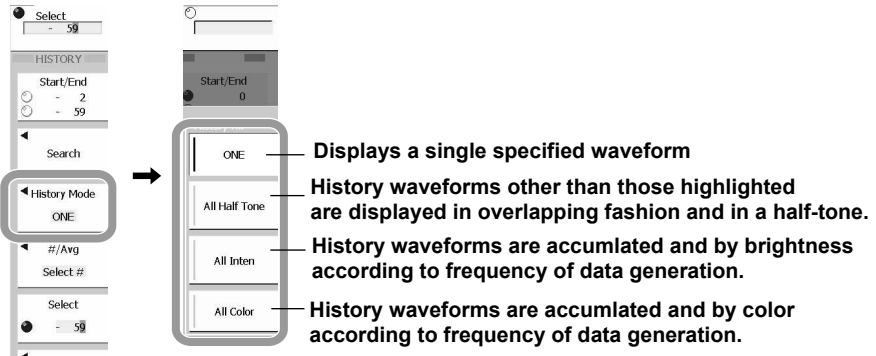

**Selecting the Highlight Waveform**

6. Press the **#/Avg** soft key.
7. Select either **Select #** or **Average**, and then press the soft key corresponding to the waveform for highlight display.  
If you selected #, select the history number.  
If you selected Average, the average value of the displayed history waveform is highlighted.
8. If **Select #** was selected in the highlighted waveform settings, press the **Select** soft key.
9. Turn the **rotary knob** and input the value for the highlighted waveform.

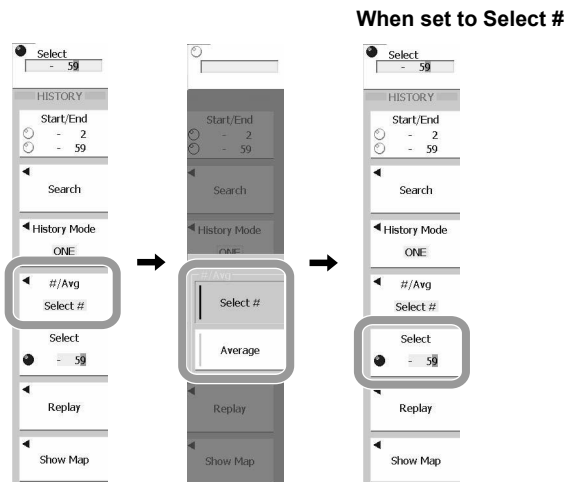

**Replaying History Waveforms**

10. Press the **Replay** soft key.
11. Press the **Down** soft key or the **Up** soft key to switch the display speed.
12. Use the **rotary knob** to select the first history waveform to be played back. The waveform number is displayed in the menu area (Select #).  
Press the < soft key to select the oldest history waveform.  
Press the > soft key to select the newest history waveform.
13. Press < **Play** to begin playback in the direction of the oldest waveform.  
Press **Play** > to begin playback in the direction of the newest waveform.  
Press the Stop soft key to stop playback.
14. Press **ESC** to return to the previous menu.

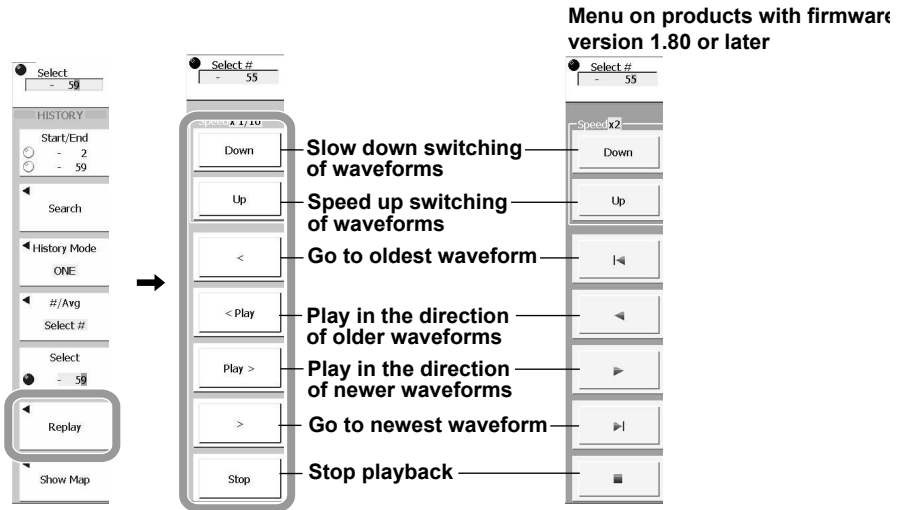

**Note**

- During playback, you can jump to the oldest or newest history waveform and continue playback from there by pressing either the < soft key or the > soft key. The playback direction remains the same as it was before the jump.
- It is also possible to change the playback speed while playback is in progress.
- Playback is not possible if the highlighted waveform was acquired in Average mode.

**Displaying a Time Stamp List**

15. Press the **Show Map** soft key.
16. Use the **rotary knob** to select the waveform to be displayed and then press **SET**.  
Press **ESC** to hide the list.

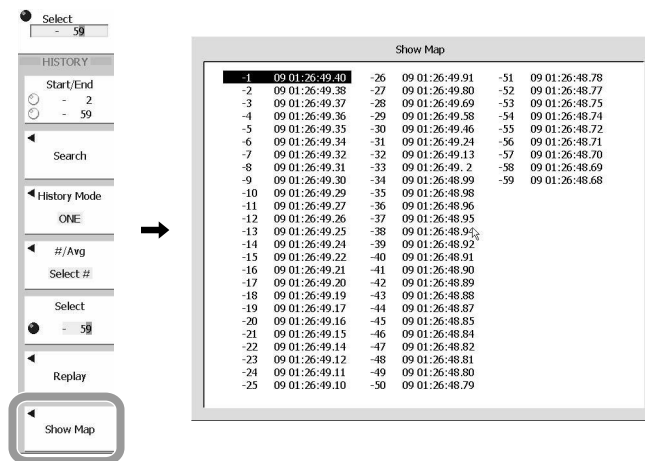

**Clearing the History Map**

17. Press the **SHIFT + HISTORY** key. During waveform acquisition, this clears the memory immediately. When waveform acquisition is stopped, the memory is cleared the next time waveform acquisition is started.

**Note**

The only operations that are allowed during waveform acquisition are ShowMap and clearing the history map.

**Explanation**

**Display Mode: History Mode**

- ONE: Only the waveform with the selected record number is displayed.
- All Half tone: Waveforms other than highlighted waveforms are accumulated, and all of the selected waveforms are accumulated.
- All Inten: The frequency of data generation is represented by brightness, and all of the selected waveforms are accumulated.
- All Color: The frequency of data generation is displayed by changing the color, and all of the selected waveforms are accumulated.

**Highlighted Waveforms: #/Avg**

- Select #: Waveform with the specified history number
- Average: Average value

**Displayed Waveforms: Select**

The setting range is from 0 to – (number of waveforms acquired –1) The most recent waveform is assigned record No. 0, and earlier waveforms are number –1, –2, –3, etc. Specify the number of the history waveform to be displayed. The number of waveforms that can be stored depends on the record length.

Record Length	DL9040L/DL9140L/DL9240L	DL9040/DL9140/DL9240
2.5KW	2000	1000
6.25KW	1000	500
12.5KW	500	250
25KW	250	120
62.5KW	120	60
125KW	60	30
250KW	30	10
625KW	10	5
1.25MW	5	2
2.5MW	2	1
6.25MW	1	-

\* The number of waveforms is not affected by whether interleave or high resolution mode is ON/OFF.

**Replay: Replay**

Waveforms are displayed in sequence, starting from the specified waveform, in the direction of older waveforms or newer waveforms.

< Play: Displays past waveforms, with the most recent first.

Play >: Displays newer waveforms in order.

**Time Stamp List: Show Map**

The numbers of the waveform data that are acquired in the acquisition memory and the trigger times are displayed in a list.

Information on 75 units of data is displayed on one screen. The rotary knob can be used to scroll the data.

**Clearing the History Map**

- Deletes all of the waveforms in acquisition memory.
- Once waveform data has been deleted, it cannot be restored.

**Notes When Setting the History Memory Function**

- History waveforms are acquired on each display update cycle when using averaging mode, roll mode or repetitive sampling mode.
- If a waveform is acquired in averaging mode or repetitive sampling mode while the trigger mode is Single, multiple waveforms are acquired before a single waveform is completed, but the only waveform that is stored in history memory is the completed waveform.
- If waveform acquisition is interrupted, the waveform that activated the trigger is displayed as the valid waveform.
- If the trigger mode is not Single, then once waveform acquisition is started, the data that was stored in the history memory before the change is cleared.  
For details on waveform acquisition conditions, see section 4.7, "Starting/Stopping Waveform Acquisition."

**Notes When Calling Up Data Using the History Memory Function**

- When the history memory menu is displayed, waveform acquisition stops. History waveforms cannot be displayed while waveform acquisition is in progress.
- You can start waveform acquisition even when the history memory menu is displayed. However, while acquisition is in progress, you cannot change the setting of the history memory function.
- Restrictions are placed on the setting so that the following relationship is maintained: last record (End)  $\leq$  Select #  $\leq$  first record (Start).
- Settings are restricted by the following condition: End Record  $\leq$  Select Record  $\leq$  Start Record.
- If waveform data is loaded from a file stored on the specified storage medium, the history waveforms up to that point are cleared. The loaded waveform data is always recalled to the record number 0 position of the history memory. If a file containing multiple waveforms is loaded, the newest waveform is recalled in the record number 0 position, the next newest waveform in -1, and so on.
- Computation and automated measurement of waveform parameters are performed on the waveform of the record number specified by Select #. Old data can be analyzed as long as you do not resume acquisition and overwrite the contents of the history memory. In the case of average display (Ave), analysis is performed on the average waveform.
- Turning OFF the power clears the history waveforms.

## 11.2 Searching the History Waveforms Using Waveform Zones (Wave History Search)

### Procedure

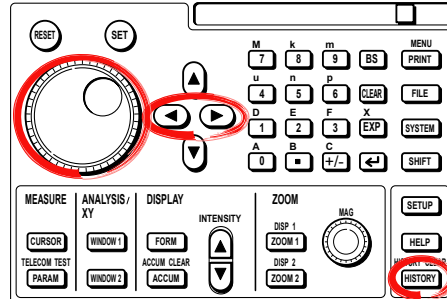

1. Press **HISTORY**.

#### Selecting the Search Logic

2. Press the **Search** soft key.
3. Press the **Logic** soft key to select AND or OR.

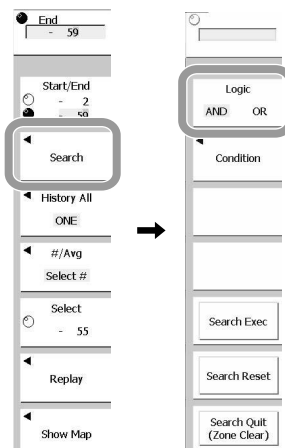

#### Selecting the Search Condition Number

4. Press the **Condition** soft key.
5. Press the **Select** soft key.
6. Select the condition number for setting the search condition and then press the corresponding soft key.

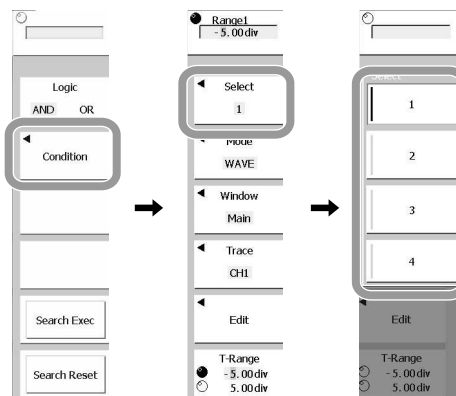

## 11.2 Searching the History Waveforms Using Waveform Zones (Wave History Search)

### Setting the Search Mode

7. Press the **Mode** soft key.
8. Press the **WAVE** soft key.

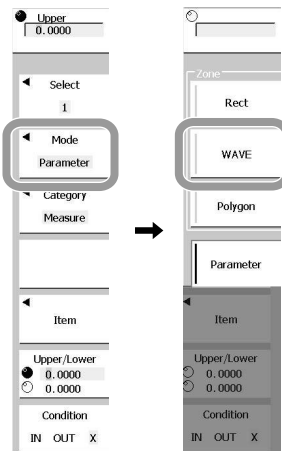

### Selecting the Search Target Window

9. Press the **Window** soft key.
10. Select from among **Main**, **Zoom1** and **Zoom2** and press the corresponding soft key.

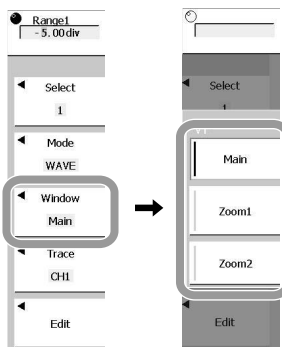

### Setting the Search Channel

11. Press the **Trace** soft key.
12. Select the target trace to be searched for from among CH1 to CH4 and M1 to M4 and press the corresponding soft key. To select M1 to M4, first switch to **M1-M4** by pressing the corresponding soft key.

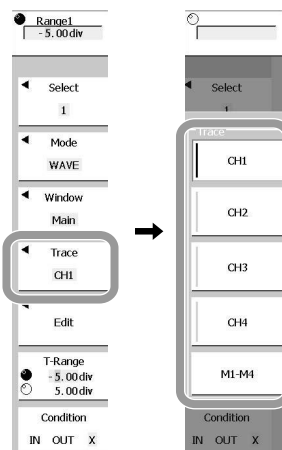

## 11.2 Searching the History Waveforms Using Waveform Zones (Wave History Search)

### Creating a New Search Zone

13. Press the **Edit** soft key.
14. Press the **New REF Trace** soft key.
15. Specify the trace that is to be the source for the zone. Press the soft key corresponding to the channel to be traced. To trace M1 to M4, first switch to M1 to M4 by pressing the **M1-M4** soft key and then press the corresponding soft key.
16. Press the **Whole/Part** soft key and specify the editing range. To edit the whole zone, select Whole; to edit part of the zone, select Part. If editing part of a zone, proceed to step 23.

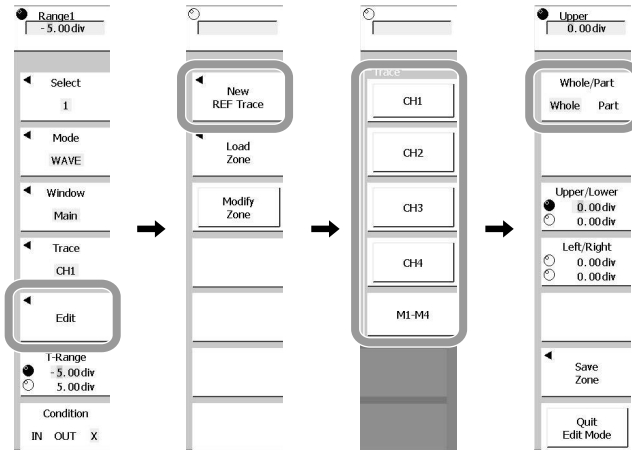

### • Editing the Whole Zone

17. Press the **Upper/Lower** or **Left/Right** soft key to select the direction in which to set the zone.
18. Using the **rotary knob**, select the zone.
19. Repeat steps 17 and 18 to edit the zone.
20. Press the **Save Zone** soft key to open the registration destination setting menu for the edited zone.
21. Select the registration destination by pressing the soft key corresponding to #1 to #4.
22. Press **ESC** to return to the previous screen.
23. Press the **Quit Edit Mode** soft key to confirm the registration.

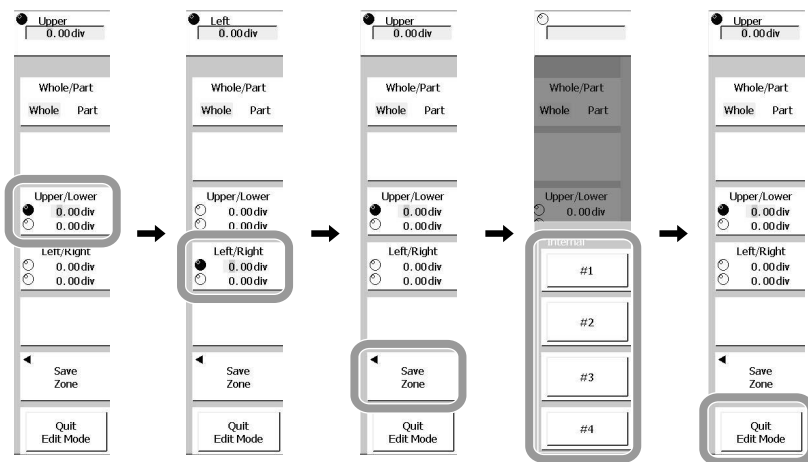



## 11.2 Searching the History Waveforms Using Waveform Zones (Wave History Search)

- **Editing a Partial Zone**

24. Press the **Whole/Part** soft key, to select Part.
25. Press the **Edit Range** soft key, to select the right cursor or left cursor.
26. With the **rotary knob**, set the left or right edge of the partial zone.  
Similarly, set the other of the left and right edges, to specify the range of the zone.
27. Press the **Upper/Lower** soft key, to select the direction for setting the zone.
28. With the **rotary knob**, create the zone. By turning the rotary knob, you can create a waveform zone with the specified range.
29. Repeat steps 24 to 27, to edit the zone.
30. To save the zone, Press the **Save Zone** soft key, opening a menu for selected where to save the edited zone.  
Select where to save the zone. Press one of the soft keys corresponding to #1 to #4 to make the selection.
31. Press **ESC** to return to the previous screen.
32. Press the **Quit Edit Mode** soft key to confirm the registration.

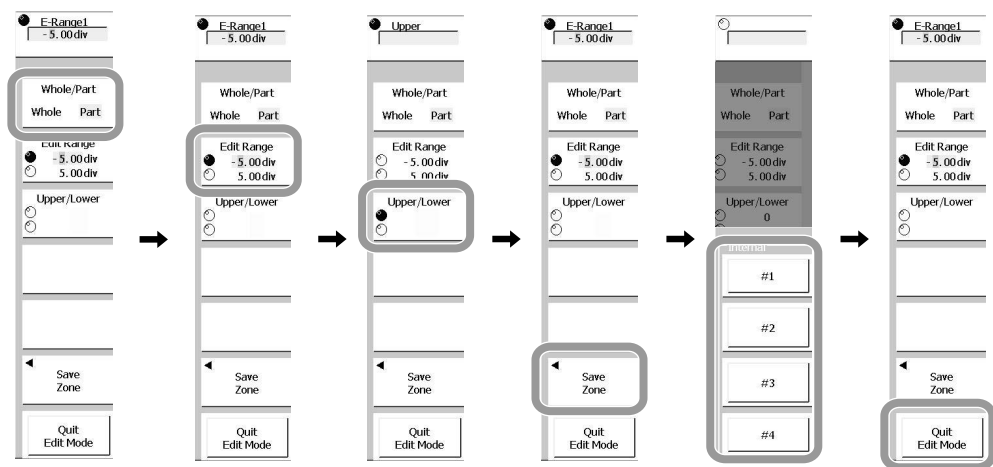

- **Modifying the Zone**

33. To modify a previously saved zone, press the **Load Zone** soft key. To modify the zone currently being used, press the **Modify Zone** soft key, and skip to step 35.
34. Select the number of the determination zone to be modified. Press one of the soft keys corresponding to #1 to #4 to make the selection. This loads the previously saved zone.
35. Follow steps 17 to 29, to modify the zone.
36. Once all modifications have been completed, press the **Quit Edit Mode** soft key.

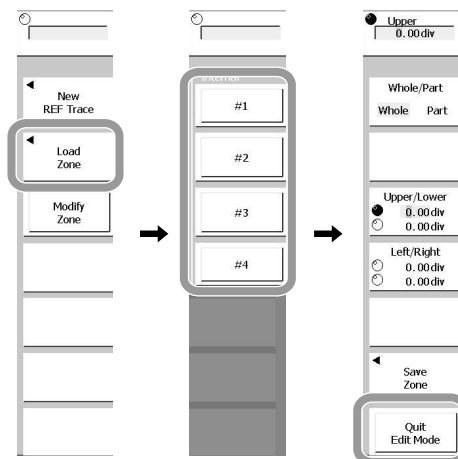

## 11.2 Searching the History Waveforms Using Waveform Zones (Wave History Search)

### Setting the Search Range

37. Press the **Time Range** soft key.
38. Use the **rotary knob** to set the search range.

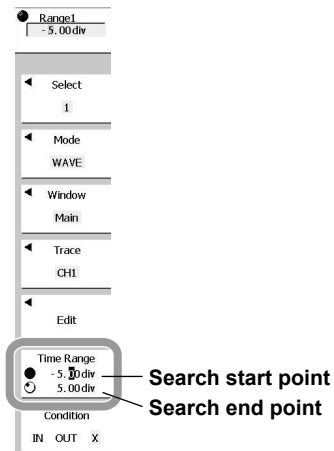

### Selecting the Search Criteria

39. Press the **Condition** soft key to select IN, OUT or X.
40. Press **ESC** to return to the history search menu.

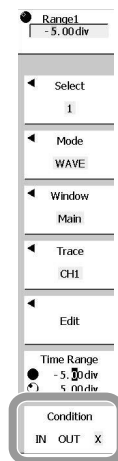

Perform the above operations for search condition numbers 1 to 4 as needed.

## 11.2 Searching the History Waveforms Using Waveform Zones (Wave History Search)

### Executing and Ending a Search

41. Press the **Search Exec** soft key. The search starts.  
The **Search Exec** soft key changes to the **Search Abort** soft key.
42. Press the **Search Abort** soft key. This ends the search.

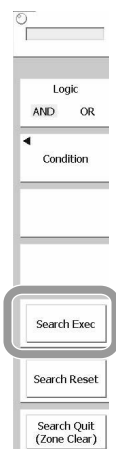

### Resetting the Search

43. Press the **Search Reset** soft key. All search conditions are reset.

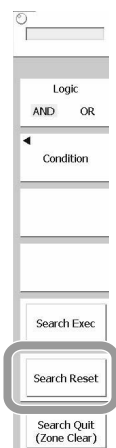

### Explanation

A zone is created based on the reference waveform, and the waveform is searched based on whether the waveform is outside the zone or within the zone. The search zone is the same as the zone for a Go/NO-GO search. (See section 7.10.)

#### **Search Condition Numbers: Select**

Select the search condition number for setting the search conditions. Four search conditions (1 to 4) can be set. The search is conducted using the logical conditions of the four search conditions.

#### **Selecting the Search Target Trace: Trace**

Select the search target trace. You can select from among CH1 to CH4, or M1 to M4. A trace that is not displayed cannot be selected.

#### **Setting the Search Conditions: Edit**

- **Creating a Search Zone**

Up to four search zones can be set. The setting range is as follows:

- Selectable range in the up and down directions:  $\pm 8$  div from the center base waveform

- Settable range in the left and right direction:  $\pm 5$  div from the center of the screen

The target waveform to be searched in the search zone registered in search condition numbers 1 through 4 can be selected from among the input signal waveforms (CH1 to CH4) or the computed waveforms (M1 to M4).

- **Selecting the Target Waveform: Trace**

You can select the waveform from among CH1 to CH4, or M1 to M4.

- **Setting the Search Conditions: Save Zone**

Set the search condition number. Each of the four search conditions can be set.

#### **Setting the Search Range: Time Range**

In the initial settings, the search range is  $\pm 5$  div on the time axis of the display frame, but this can be limited to the desired range. The concept behind the search range is the same as that of the setting range for the cursor display position in cursor measurement.

#### **Setting the Search Criteria: Condition**

IN: Search the history waveforms for target waveforms lying inside the search zone.

OUT: Search the history waveforms for target waveforms going outside the search zone.

X: No search is performed.

#### **Setting the Search Logic: Logic**

AND: Search for history waveforms for which all search condition numbers 1 to 4 are true

OR: Search for history waveforms for which at least one of the condition numbers 1 to 4 is true

#### **Note**

---

If you press the Search Quit (Zone Clear) soft key on the menu that appears when you press the Search soft key, the search zone is cleared, and the screen returns to the top menu of the HISTORY key.

---

# 11.3 Searching the History Waveforms Using Rectangular Zones (RECT History Search)

## Procedure

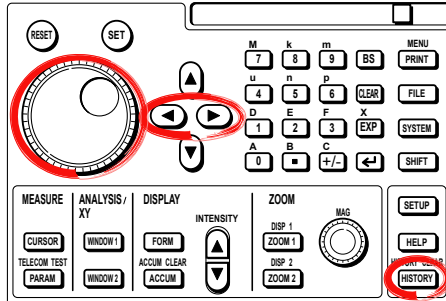

1. Press **HISTORY**.

### Selecting the Search Logic

2. Press the **Search** soft key.
3. Press the **Logic** soft key to select AND or OR.

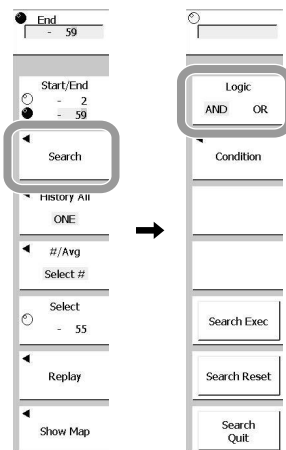

### Selecting the Search Condition Number

4. Press the **Condition** soft key.
5. Press the **Select** soft key.
6. Select the condition number for setting the search condition and then press the corresponding soft key.

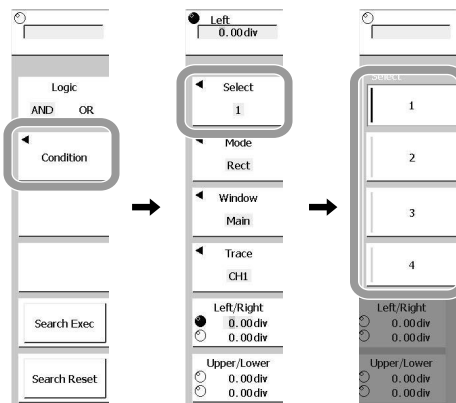

### 11.3 Searching the History Waveforms Using Rectangular Zones (RECT History Search)

#### Switching the Search Mode

7. Press the **Mode** soft key.
8. Press the **Rect** soft key.

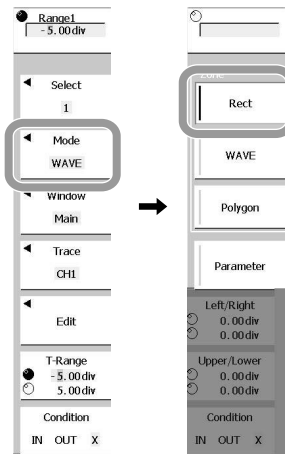

#### Selecting the Search Target Window

9. Press the **Window** soft key.
10. Select from among **Main**, **Zoom1**, **Zoom2**, **XY1** or **XY2** and press the corresponding soft key.

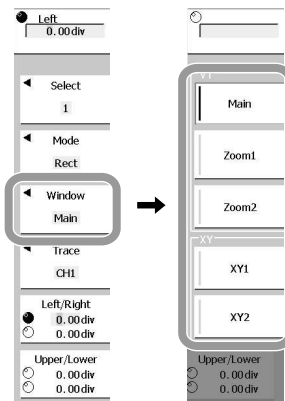

#### Setting the Search Channel

11. Press the **Trace** soft key.
12. Select the trace to be searched for from among CH1 to CH4 and M1 to M4 and press the corresponding soft key. To select M1 to M4, first switch to **M1-M4** by pressing the corresponding soft key.

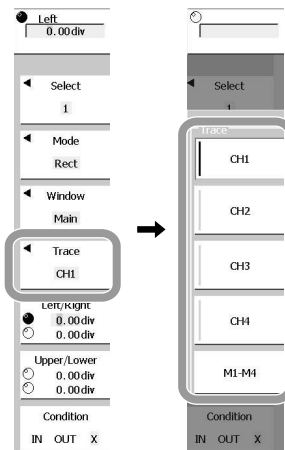

### Setting the Search Zone

The search zone is displayed when Condition is set to IN or OUT in step 19.

13. Press the **Left/Right** soft key to select the direction in which to set the zone.
14. Use the **rotary knob** to set the left edge and right edge of the zone.
15. Repeat steps 13 and 14 to edit the zone.
16. Press the **Upper/Lower** soft key to select the direction in which to set the zone.
17. Use the **rotary knob** to set the top edge and bottom edge of the zone.
18. Repeat steps 16 and 17 to edit the zone.

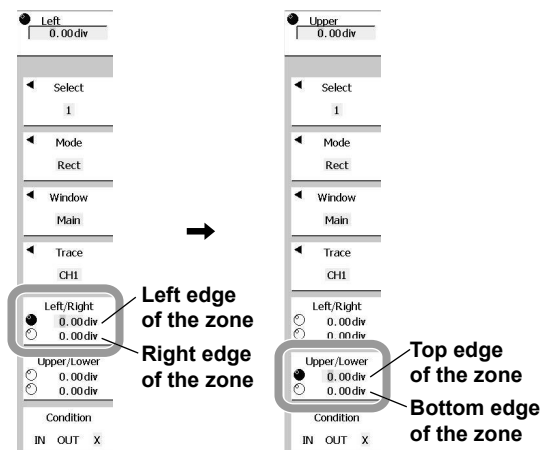

### Selecting the Search Criteria

19. Press the **Condition** soft key to select IN, OUT or X.
20. Press **ESC** to return to the history search menu.

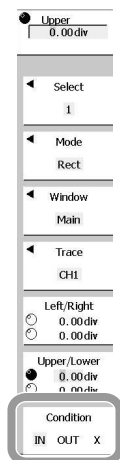

Perform the above operations for search condition numbers 1 to 4 as needed.

### 11.3 Searching the History Waveforms Using Rectangular Zones (RECT History Search)

---

#### Executing and Ending a Search

21. Press the **Search Exec** soft key. The search starts.  
The **Search Exec** soft key changes to the **Search Abort** soft key.
22. Press the **Search Abort** soft key. This ends the search.

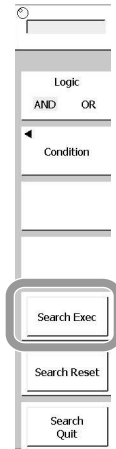

#### Resetting the Search

23. Press the **Search Reset** soft key. All search conditions are reset.

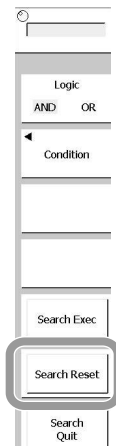



### Explanation

Create a rectangle by setting the top and bottom and left and right limit values on the screen, and then search the waveforms according to whether the trace passes through that range or not. For details on the rectangular zone see section 7.11.

#### Search Condition Numbers: Select

Select the search condition number for setting the search conditions. Four search conditions (1 to 4) can be set. The search is conducted using the logical conditions of the four search conditions.

#### Setting the Search Conditions

- **Setting the Search Zone: Left/Right, Upper/Lower**

Set the range for searching the search conditions. One search zone can be set. The setting range is as follows:

Selectable range in the up and down directions:  $\pm 5$  div ( $\pm 4$  div for an XY waveform)

setting resolution from the base waveform: 0.01 divisions

Settable range in the left and right direction:  $\pm 4$  div setting resolution from the center of the screen: 0.01 divisions

- **Selecting the Search Target Window: Window**

Main: Sets a normal waveform as the target.

Zoom1: Sets the waveform in zoom box 1 as the target.

Zoom2: Sets the waveform in zoom box 2 as the target.

XY1: Sets the waveform in XY window 1 as the target.

XY2: Sets the waveform in XY window 2 as the target.

For details on Zoom 1 and Zoom 2 see section 10.4.

- **Selecting the Target Waveform: Trace**

You can select the waveform from among CH1 to CH4, or M1 to M4.

- **Selecting the Search Criteria: Condition**

IN: The history waveforms are searched according to whether or not the target waveform is in the search zone.

OUT: The history waveforms are searched according to whether or not the target waveform is outside the search zone.

X: No search is performed.

#### Selecting the Search Logic: Logic

AND: Search for history waveforms for which all condition numbers 1 to 4 are true

OR: Search for history waveforms for which at least one of condition numbers 1 to 4 is true

# 11.4 Searching History Waveforms Using Automatic Measurements of Waveform Parameters (MEASURE History Search)

## Procedure

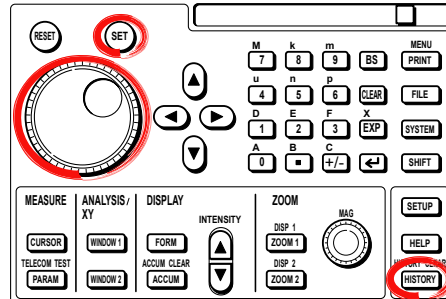

1. Press **HISTORY**.

### Selecting the Search Logic

2. Press the **Search** soft key.
3. Press the **Logic** soft key to select AND or OR.

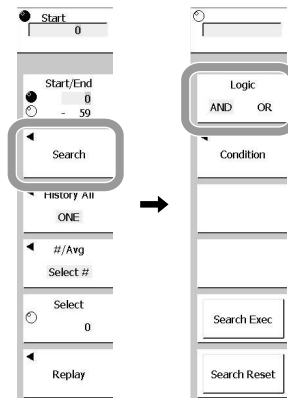

### Selecting the Search Condition Number

4. Press the **Condition** soft key.
5. Press the **Select** soft key.
6. Select the condition number for setting the search condition and then press the corresponding soft key.

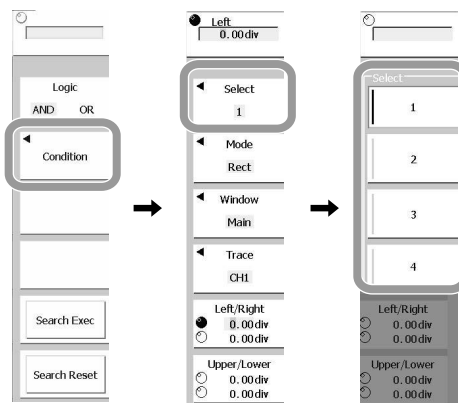

## 11.4 Searching History Waveforms Using Automatic Measurements of Waveform Parameters (MEASURE History Search)

### Switching the Search Mode

7. Press the **Mode** soft key.
8. Press the **Parameter** soft key.
9. Press the **Category** soft key.
10. Press the **Measure** soft key.

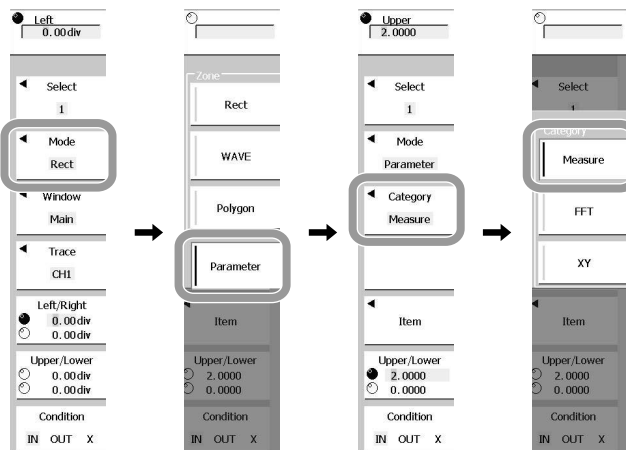

### Setting the Measurement Items

11. Press the **Item** soft key.

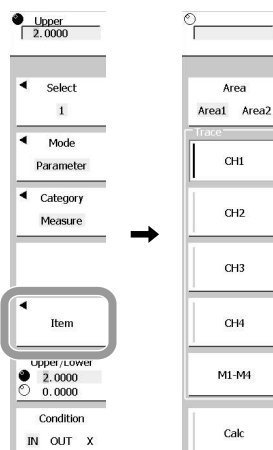

### Selecting the Measurement Target Area

12. Press the **Area** soft key to select Area1 or Area2.

Another selection menu appears on products with firmware version 3.6 or later. Select Area1 or Area2 on that menu.

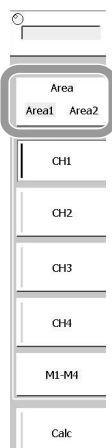

## 11.4 Searching History Waveforms Using Automatic Measurements of Waveform Parameters (MEASURE History Search)

### Setting the Measurement Target Channel

13. Press the soft key corresponding to the waveform to be measured to set the source waveform.

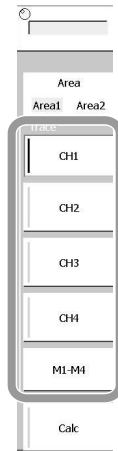

### Setting the Measurement Items

14. Use the **rotary knob** to select the item to be set and then press **SET**. The selected item is checked.

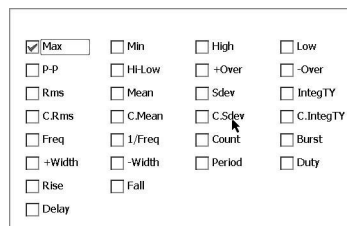

### Setting the Calculation

15. Press the **Calc** soft key.  
On products with firmware version 3.6 or later, pressing the **Area** soft key displays a selection menu. Press the **Calc** soft key on this menu.
16. Use the **rotary knob** to select the equation to be set and then press **SET**. The selected calculation is checked.
17. Press **ESC**.

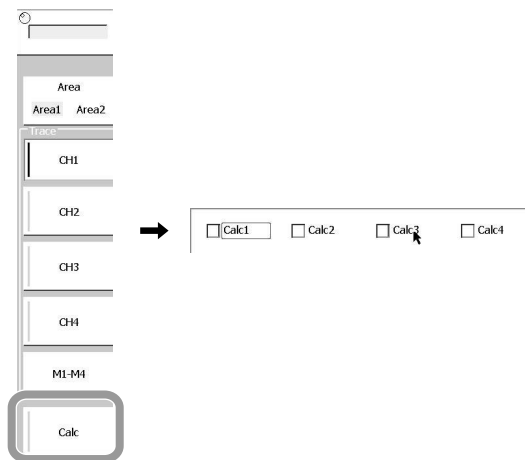

## 11.4 Searching History Waveforms Using Automatic Measurements of Waveform Parameters (MEASURE History Search)

### Setting the Search Zone

18. Press the **Upper/Lower** soft key to select the item for which the range is to be set.
19. Use the **rotary knob** to set the top edge and bottom edge of the range.

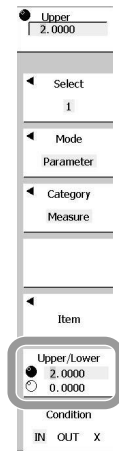

### Selecting the Search Criteria

20. Press the **Condition** soft key to select IN, OUT or X.
21. Press **ESC** to return to the history search menu.

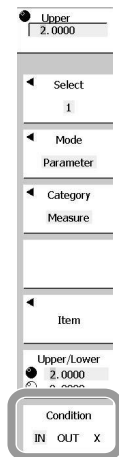

Perform the above operations for search condition numbers 1 to 4 as needed.

## 11.4 Searching History Waveforms Using Automatic Measurements of Waveform Parameters (MEASURE History Search)

### Executing and Ending a Search

22. Press the **Search Exec** soft key. The search starts.  
The **Search Exec** soft key changes to the **Search Abort** soft key.
23. Press the **Search Abort** soft key. This ends the search.



### Resetting the Search

24. Press the **Search Reset** soft key. All search conditions are reset.

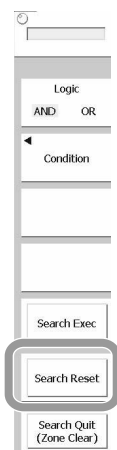

### Explanation

Searches waveforms according to whether automatically measured waveform parameters based on automatically measured values fall within the specified range or not. For details on waveform parameters see section 10.2.

#### Search Condition Numbers: Select

Select the search condition number for setting the search conditions. Four search conditions (1 to 4) can be set. The search is conducted using the logical conditions of the four search conditions.

#### Measurement area: Area

Select Area 1 or Area 2 as the measurement area.

#### Measurement Parameters: Item

You can select from among the following 27 items. For details see section 10.2.

## 11.4 Searching History Waveforms Using Automatic Measurements of Waveform Parameters (MEASURE History Search)

### • Measurement Parameters on the Voltage-Axis

Max	Maximum voltage value [V]
Min	Minimum voltage value [V]
High	High voltage value [V]
Low	Low voltage value [V]
P-P	P-P value (Max – min) [V]
Hi-Low	High voltage value – Low voltage value [V]
+Over	Overshoot amount [%] $(\text{Max} - \text{High}) / (\text{High} - \text{Low}) \times 100$
–Over	Undershoot amount [%] $(\text{Low} - \text{Min}) / (\text{High} - \text{Low}) \times 100$
Rms	Effective voltage [V] $(1/\sqrt{n})(\sum(x_i^2))^{1/2}$
Mean	Mean voltage [V] $(1/n)\sum x_i$
Sdev	Standard deviation [V] $(\sum(x_i^2) - (\sum x_i)^2/n)/n)^{1/2}$
IntegTY	Total area for both positive and negative amplitude [Vs]
V1	Voltage at the intersection of each trace and T1 (left cursor defining the measurement range)
V2:	Voltage at the intersection of each trace and T2 (right cursor defining the measurement range)

### • Other Measurement Parameters

C.Rms	Effective value over integer multiple of time during cycle within set range [V]
C.Mean	Average voltage over integer multiple of time during cycle within set range [V]
C.Sdev	Standard deviation over integer multiple of time during cycle within set range [V]
C.IntegTY	Total area for both positive and negative amplitude of each period for the specified range [Vs]
Freq	Average frequency [Hz]
1/Freq	Average cycle [s]
Count	Edge count [no unit]
Burst	Burst width [s]
+Width	Time width above the reference line [s]
–Width	Time width below the reference line [s]
Period	Cycle [s] (+Width) + (–Width)
Duty	Duty ratio [%]
Rise	Rise time [s]
Fall	Fall time [s]
Delay	Delay [s]
ΔT	Time difference between T1 and T2

### Upper limit/lower limit: Upper/Lower

This value can be set in the following range.

Upper: –1.0E+31 to 1.0E+31

Lower: –1.0E+31 to 1.0E+31

### Search Criteria: Condition

IN: Searches for a history waveform with the specified waveform parameter value within the set range.

OUT: Searches for a history waveform with the specified waveform parameter outside the set range.

X: No search is performed.

### Selecting the Search Logic: Logic

AND: Search for history waveforms for which all condition numbers 1 to 4 are true

OR: Search for history waveforms for which at least one condition number 1 to 4 is true

# 11.5 Searching the History Waveforms Using Polygon Waveforms (POLYGON History Search)

## Procedure

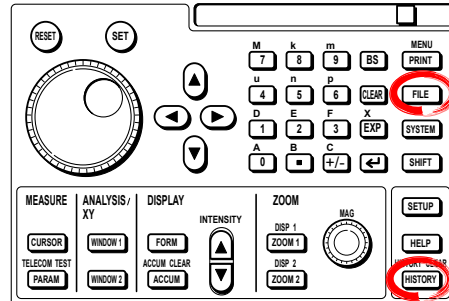

### Loading Polygon Graphics

1. Press **FILE**.
2. Specify the directory in a PC card or USB memory where the polygon graphics file is stored and then select the file.
3. Press the **OPEN** soft key.
4. Select the target file and then press **SET**.
5. Press the **LOAD** soft key. A menu used to load the file appears.
6. Press the **Type** soft key. A menu appears for selecting a polygon or mask pattern.
7. Press the **Zone Polygon** soft key.
8. Press the soft key for the zone number to be loaded.
9. Press the **Load EXEC** soft key. This loads the selected file.

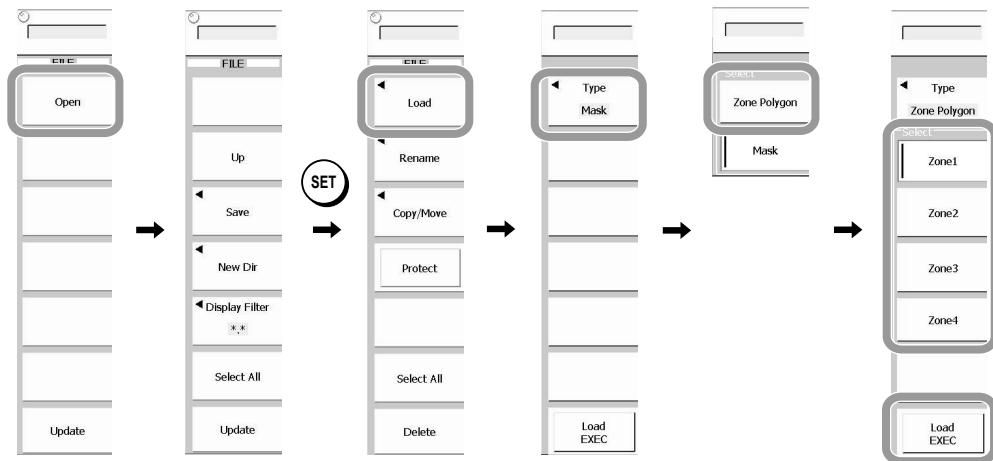

10. Press **HISTORY**.



**Selecting the Search Logic**

11. Press the **Search** soft key.
12. Press the **Logic** soft key to select AND or OR.

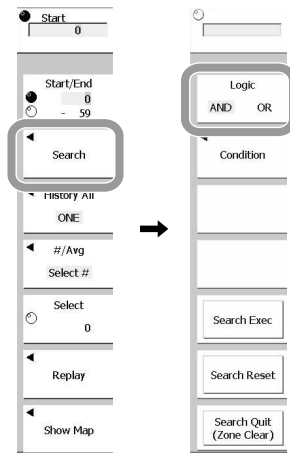

**Selecting the Search Condition Number**

13. Press the **Condition** soft key.
14. Press the **Select** soft key.
15. Select the condition number for setting the search condition and then press the corresponding soft key.

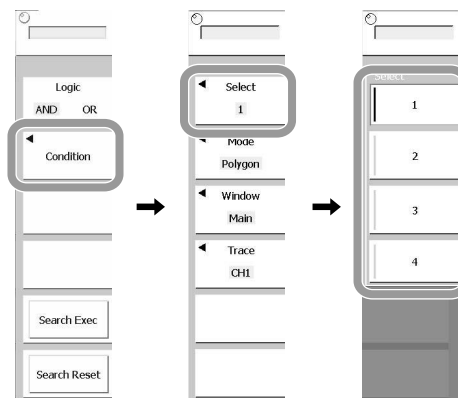

**Switching the Search Mode**

16. Press the **Mode** soft key.
17. Press the **Polygon** soft key.

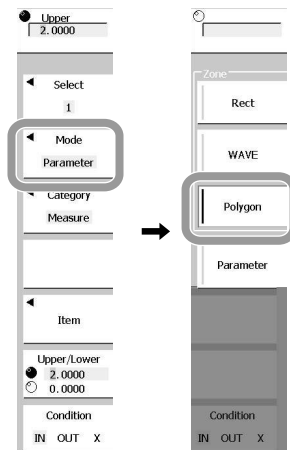

## 11.5 Searching the History Waveforms Using Polygon Waveforms (POLYGON History Search)

### Selecting the Search Window

18. Press the **Window** soft key.
19. Select from among **Main**, **Zoom1**, **Zoom2**, **XY1** or **XY2** and press the corresponding soft key.

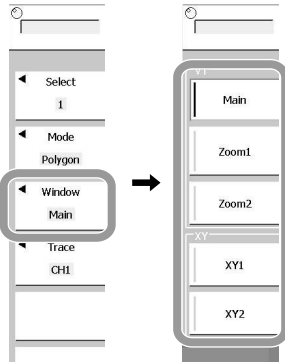

### Setting the Search Channel

20. Press the **Trace** soft key.
21. Select the trace to be searched for from among CH1 to CH4 and M1 to M4 and press the corresponding soft key. To select M1 to M4, first switch to **M1-M4** by pressing the corresponding soft key.

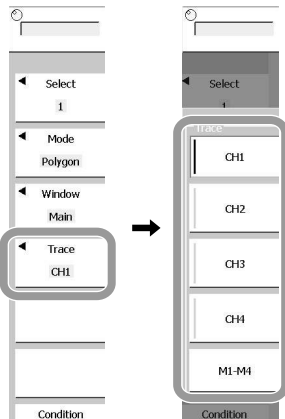

### Selecting the Search Criteria

22. Press the **Condition** soft key to select IN, OUT or X.
23. Press **ESC** to return to the history search menu.

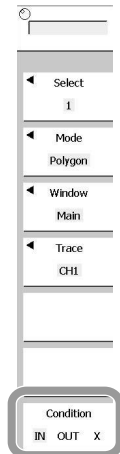

## 11.5 Searching the History Waveforms Using Polygon Waveforms (POLYGON History Search)

Perform the above operations for search condition numbers 1 to 4 as needed.

### Executing and Ending a Search

24. Press the **Search Exec** soft key. The search starts.  
The **Search Exec** soft key changes to the **Search Abort** soft key.
25. Press the **Search Abort** soft key. This ends the search.

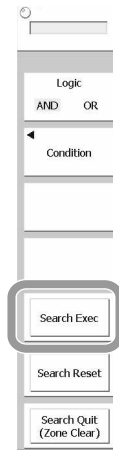

### Resetting the Search

26. Press the **Search Reset** soft key. All search conditions are reset.



### Explanation

The history waveform is searched for according to whether it is inside or outside the range of the polygon graphic that was created on a PC.

#### **Search Condition Numbers: Select**

Select the search condition number for setting the search conditions. Four search conditions (1 to 4) can be set. The search is conducted using the logical conditions of the four search conditions.

#### **Setting the Search Conditions**

- **Setting the Search Conditions: Select**

Set the search condition number for setting the search conditions.

Each of the four search conditions can be set.

- **Applicable Channels: Trace**

You can select the target trace from among CH1 to CH4, or M1 to M4.

- **Search Window: Window**

Select the window to be searched

from among Main, Zoom1, Zoom2, XY1 or XY2.

- **Search Criteria: Condition**

IN: The history waveforms are searched according to whether or not the target waveform is in the search zone.

OUT: The history waveforms are searched according to whether or not the target waveform is outside the search zone.

X: No search is performed.

#### **Selecting the Search Logic: Logic**

AND: Search for history waveforms for which all condition numbers 1 to 4 are true

OR: Search for history waveforms for which at least one condition number 1 to 4 is true

# 11.6 Searching the History Waveforms Using the FFT Parameter (FFT History Search)

## Procedure

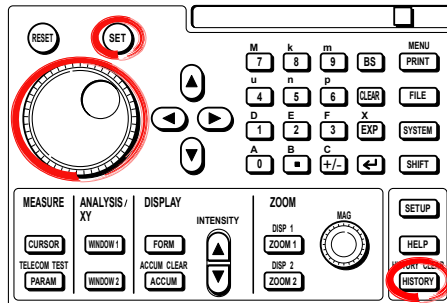

1. Press **HISTORY**.

### Selecting the Search Logic

2. Press the **Search** soft key.
3. Press the **Logic** soft key to select AND or OR.

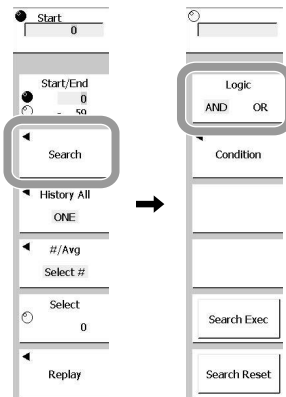

### Selecting the Search Condition Number

4. Press the **Condition** soft key.
5. Press the **Select** soft key.
6. Select the condition number for setting the search condition and then press the corresponding soft key.

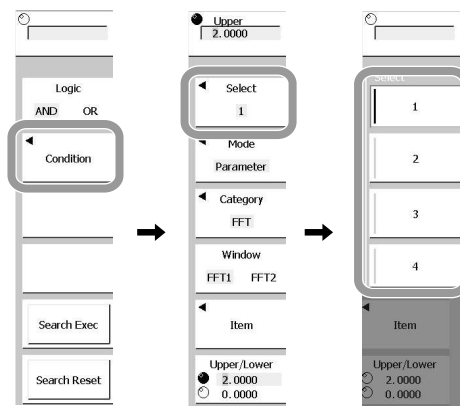

## 11.6 Searching the History Waveforms Using the FFT Parameter (FFT History Search)

### Switching the Search Mode

7. Press the **Mode** soft key.
8. Press the **Parameter** soft key.
9. Press the **Category** soft key.
10. Press the **FFT** soft key.

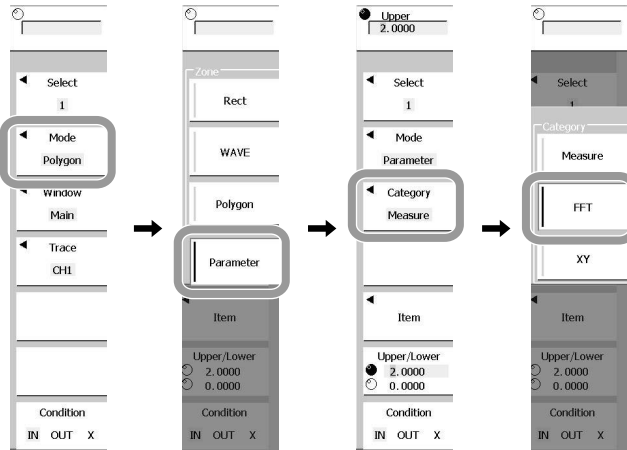

### Selecting the Search Window

11. Press the **Window** soft key to select FFT1 or FFT2.

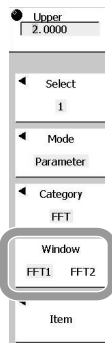

### Setting the Measurement Items

12. Press the **Item** soft key.
13. Press the **Basic** soft key.
14. Select the item from the dialog box that appears. Use the **rotary knob** to select the item and then press SET to begin checking.

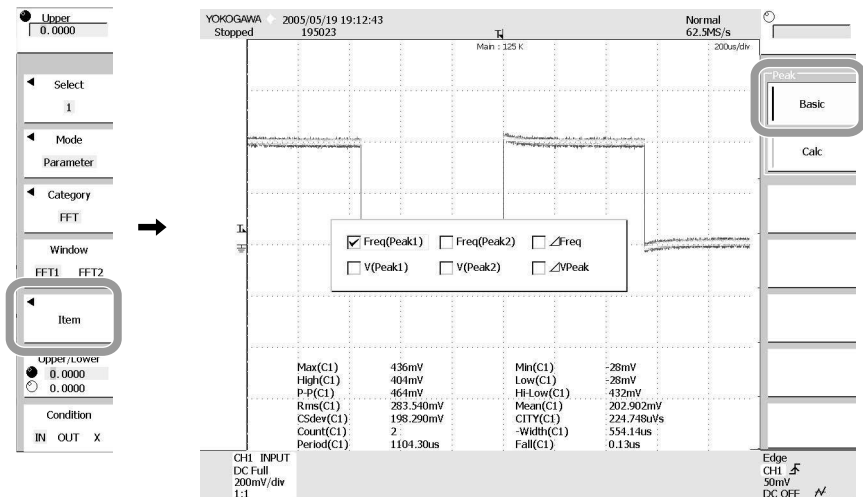

## 11.6 Searching the History Waveforms Using the FFT Parameter (FFT History Search)

### Setting the Calculation

15. When selecting a calculated value using an FFT value for the item, press the **Calc** soft key.
16. Select the Calc to be used and then begin the check.  
Use the **rotary knob** to select the item and then press SET to begin checking.  
Select from the formulas set for the FFT analysis function.
17. Press **ESC**.

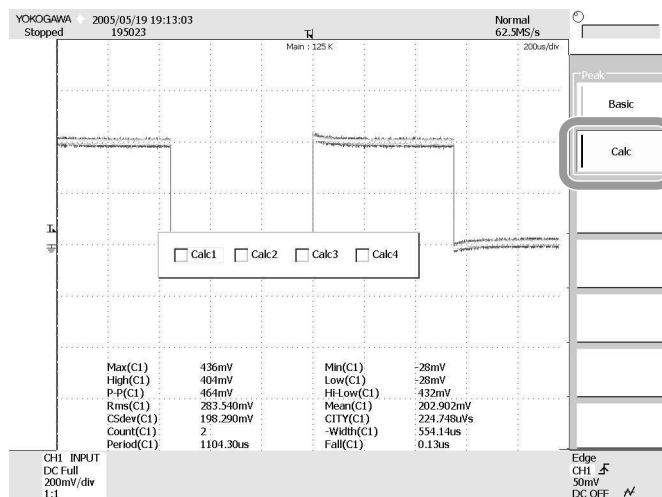

### Setting the Search Range

18. Press the **Upper/Lower** soft key to select the item for which the range is to be set.
19. Use the **rotary knob** to set either Upper or Lower.

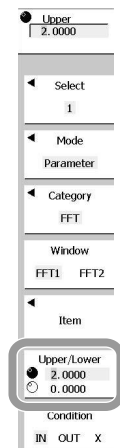

## 11.6 Searching the History Waveforms Using the FFT Parameter (FFT History Search)

### Selecting the Search Criteria

20. Press the **Condition** soft key to select IN, OUT or X.
21. Press **ESC** to return to the history search menu.

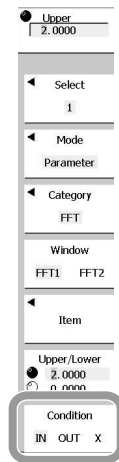

Perform the above operations for search condition numbers 1 to 4 as needed.

### Executing and Ending a Search

22. Press the **Search Exec** soft key. The search starts.  
The **Search Exec** soft key changes to the **Search Abort** soft key.
23. Press the **Search Abort** soft key. This ends the search.

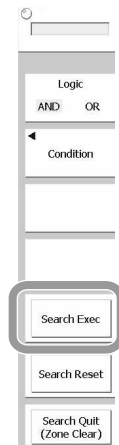



**Resetting the Search**

24. Press the **Search Reset** soft key. All search conditions are reset.

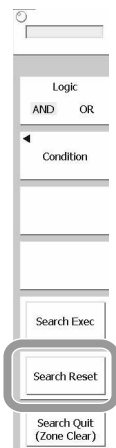

**Explanation**

The waveform is searched for according to whether it is inside or outside the range set by the measured values of the FFT waveform.

**Search Condition Numbers: Select**

Select the search condition number for setting the search conditions. Four search conditions (1 to 4) can be set. The search is conducted using the logical conditions of the four search conditions.

**Search Window: Window**

Select the window to be searched from among either FFT1 or FFT2.

**Search Range: Upper/Lower**

Set the upper limit and the lower limit for the value of the specified search item.

**Search Criteria: Condition**

- IN: Searches for a history waveform within the range set by the specified FFT values.
- OUT: Searches for a history waveform outside the range set by the specified FFT values.
- X: No search is performed.

**Selecting the Search Logic: Logic**

- AND: Search for history waveforms for which all condition numbers 1 to 4 are true
- OR: Search for history waveforms for which at least one condition number 1 to 4 is true

# 11.7 Searching History Waveform by XY Waveform Parameter (XY History Search)

## Procedure

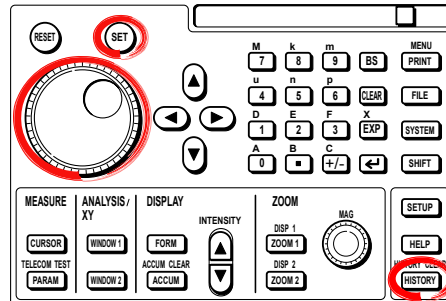

1. Press **HISTORY**.

### Selecting the Search Logic

2. Press the **Search** soft key.
3. Press the **Logic** soft key, to select AND or OR.

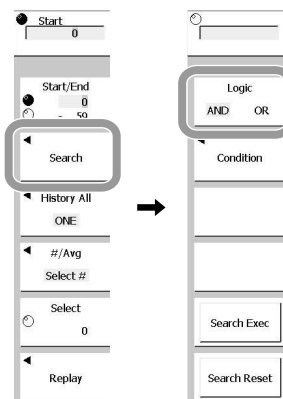

### Selecting the Search Condition Number

4. Press the **Condition** soft key.
5. Press the **Select** soft key.
6. Select the condition number for setting the search condition, and press the corresponding soft key.

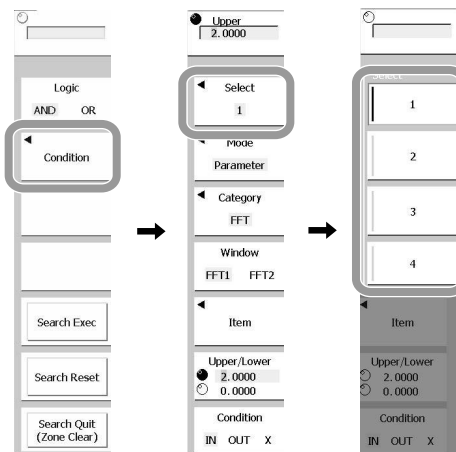

## 11.7 Searching History Waveform by XY Waveform Parameter (XY History Search)

### Changing the Search Mode

7. Press the **Mode** soft key.
8. Press the **Parameter** soft key.
9. Press the **Category** soft key.
10. Press the **XY** soft key.

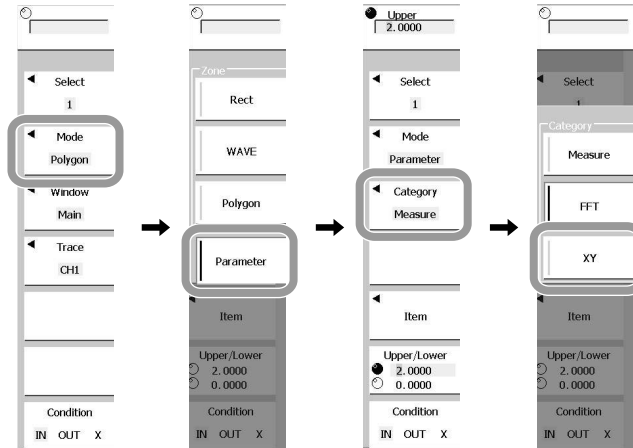

### Selecting the Search Window

11. Press the **Window** soft key, to select XY1 (XY in Window1) or XY2 (XY in Window2).

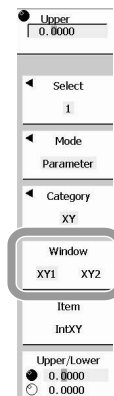

### Setting the Search Range

12. Press the **Upper/Lower** soft key, to select the item for setting the range.
13. With the **rotary knob**, set Upper or Lower.

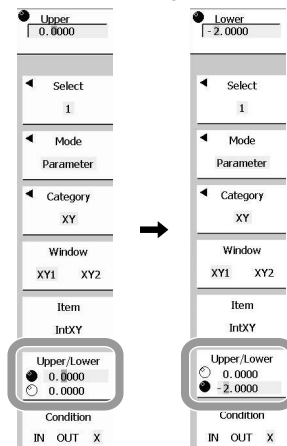

## 11.7 Searching History Waveform by XY Waveform Parameter (XY History Search)

### Selecting the Search Condition

14. Press the **Condition** soft key, to select IN, OUT, or X.
15. Press **ESC**, to return to the history search menu.

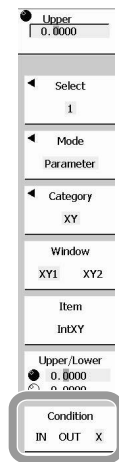

Carry out the above steps as required for search condition numbers 1 to 4.

### Executing and Ending a Search

16. Press the **Search Exec** soft key. This starts the search.  
The **Search Exec** soft key changes to the **Search Abort** soft key.
17. Press the **Search Abort** soft key. This ends the search.

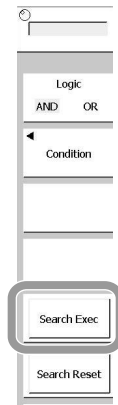

### Search Reset

18. Press the **Search Reset** soft key. This resets all search conditions.

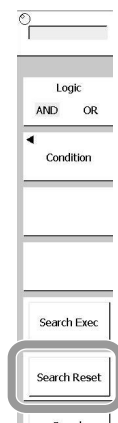

### Explanation

Using an XY waveform area calculation value, you can search for waveforms inside or outside the specified range.

#### Determination condition

- **Setting the Search Condition: Select**  
Select the search condition number for setting the search condition. You can set each of the four search conditions.
- **Selecting the Search Target Window: Window**  
XY1: Use the XY Window1 waveform of the analysis window as target.  
XY2: Use the XY Window2 waveform of the analysis window as target.
- **Setting the Search Range: Upper/Lower**  
Set the upper and lower limits for the XY waveform area.
- **Selecting the Determination Condition: Condition**  
IN: Search the history waveforms for the XY waveform area within the upper and lower limits.  
OUT: Search the history waveforms for the XY waveform area outside the upper and lower limits.  
X: No history waveform search is performed.

## 12.1 Installing the Roll Paper into the Built-in Printer (Optional)

### Printer Roll Paper

The DL9000 uses a dedicated roll paper provided by YOKOGAWA. Do not use other types of roll paper. When you are using the printer for the first time, use the roll paper that came with the package. Order extra rolls from your nearest YOKOGAWA dealer.

Part No.: B9988AE  
Specifications: Thermalsensible paper, 10 m  
Minimum Quantity: 10 rolls

### Handling the Roll Paper

The paper is a thermalsensible paper that changes color with the application of heat. Take note of the following points.

#### Storage Precautions

The paper starts changing color at around 70°C. It is affected by heat, humidity, light, and chemicals regardless of whether the paper has been used.

- Store the paper rolls in a cool, dry, and dark place.
- After opening the package, use it quickly.
- If the paper is left in contact with plastic film (such as a vinyl chloride film or Scotch tape) containing plasticizers for an extended time, the paper will lose some of its ability to reproduce color. If you are going to store the paper in a folder, for example, use a folder made of polypropylene or wood fiber.
- When using glue on the paper, do not use glue containing organic solvents such as alcohol or ether, as they will change the color of the paper.
- For prolonged storage, we suggest you make copies of the results printed on the roll paper. Due to the characteristics of the thermalsensible paper, it may lose color over time.

#### Handling Precautions

- Be sure to use only genuine paper rolls provided by YOKOGAWA.
- Touching the paper with sweaty hands can leave finger print marks or blur the printing.
- Rubbing the surface with a hard object can cause the paper to change color due to the heat caused by friction.
- If chemicals, oil, or other liquids come in contact with the paper, the paper may change color or the printing may fade.

## Installing the Roll Paper

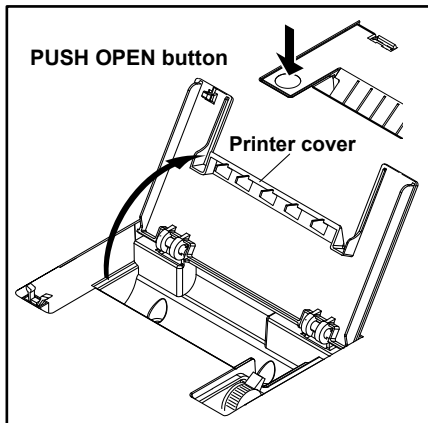

1. Press the PUSH OPEN button to unlock the printer cover. To open the printer cover, lift the handle on the right side of the printer cover.

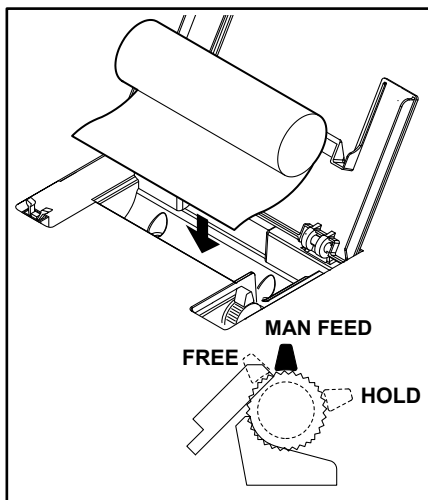

2. Move the release arm located on the right near the front to the MAN FEED position. Hold the roll paper so that the inner side of the roll paper (the side that is not glossy) is facing up and then insert the roll paper in the tray.

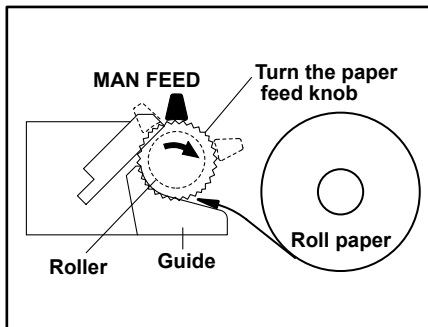

3. Insert the edge of the roll paper evenly in the space between the roller and the black guide, then rotate the paper feed knob towards the roll paper until about 10 cm of the paper extends beyond the top of the roller.

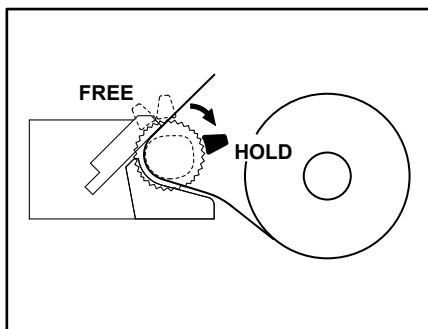

4. Move the release arm to the FREE position and straighten out the paper. Then, move the release arm to the HOLD position. The printing will fail with an error message if the release arm is in the FREE or MAN FEED position during operation.

## 12.1 Installing the Roll Paper into the Built-in Printer (Optional)

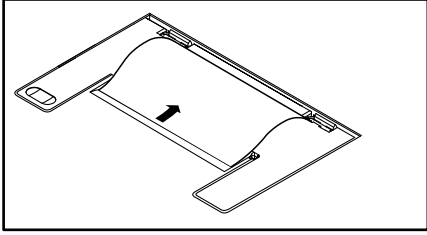

5. Pull the printer cover back to its original position and close the cover.  
Push the printer cover down firmly until it clicks into place.

### **Note**

Make sure to move the release arm to the HOLD position when closing the printer cover.



## 12.2 Printing Using the Built-in Printer (Optional)

### Procedure

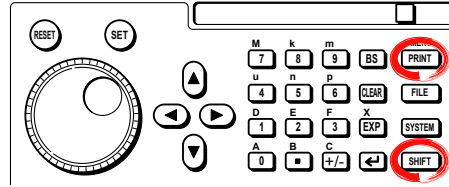

1. Press the **SHIFT + PRINT** key.

### Selecting a Printer

2. Press the **Copy to (copy destination)** soft key. The printer selection menu appears.
3. Press the **Built-in (built-in printer)** soft key.

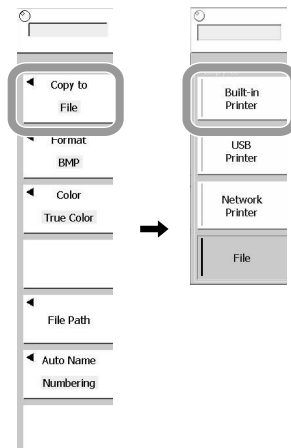

### Setting Output Type

4. Press the **High Reso (high resolution)** soft key to select ON or OFF.

### Printing

5. Press **PRINT**. The screen image is printed on the built-in printer.  
To abort printing, press PRINT while printing is in progress.  
While the data is being printed, the  is displayed at the lower left corner of the screen.

### Explanation

#### Output format: High Reso

The High Reso setting allows the following pixel sizes to be printed.

OFF: 1024 × 768 (XGA size) monochrome printing

ON: 2048 × 768 monochrome printing

Switching High Reso on or off does not affect the printing dimensions, and therefore when ON, the horizontal resolution is twice normal.

## 12.3 Printing Using a USB Printer

### Procedure

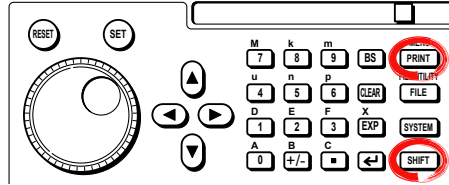

1. Connect the DL9000 and a USB printer using a USB cable. For details, see the explanation in this section.

### Selecting a Printer

2. Press the **SHIFT + PRINT** key.
3. Press the **Copy to (copy destination)** soft key. The printer selection menu appears.
4. Press the **USB (USB printer)** soft key.

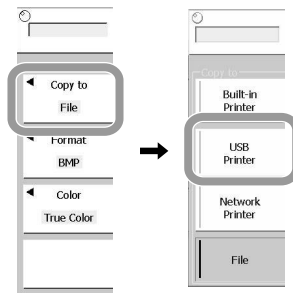

### Checking the Connected Printer

5. Press the **Printer (printer)** soft key. The type of printers supported by the DL9000 is displayed.
6. Press the soft key corresponding to the connected printer.

### Setting the Color

7. Press the **Color (color)** soft key to select ON or OFF.

### Printing

8. Press **PRINT**. The screen image is printed on the USB printer. To abort printing, press PRINT while printing is in progress. While the data is being printed, the  is displayed at the lower left corner of the screen.

**Explanation**

You can print the screen image to a USB printer with the USB interface.

**USB Peripheral Connectors**

To connect a USB printer to the DL9000, connect a USB cable to the USB Peripheral connector. There are two USB peripheral connectors (ports).

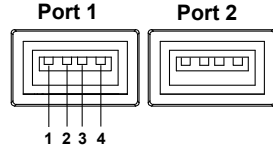

Pin No.	Signal Name
1	VBUS: + 5 V
2	D -: - Data
3	D +: + Data
4	GND: Ground

**Printers That Can Be Used**

USB printers conforming to USB Printer Class Version 1.1 that support the following print formats can be used.

**Note**

- Connect only the printers that are allowed.
- For details on USB printers that have been tested for compatibility, contact your nearest YOKOGAWA dealer.

**Connection Procedure**

When connecting a USB printer, directly connect the printer to the DL9000 using a USB cable as shown below. You can connect the USB cable regardless of whether the power to the DL9000 is ON or OFF (supports hot-plugging). Connect the type A connector of the USB cable to the DL9000; connect the type B connector to the printer. When the power switch is ON, the printer is detected and enabled after it is connected.

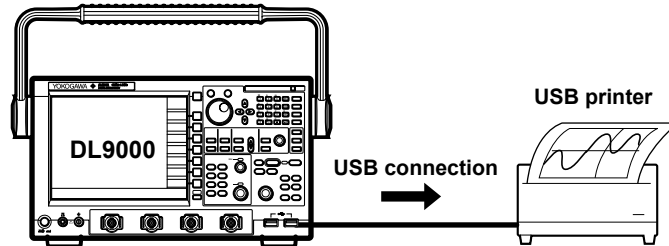

**Note**

- Connect the printer directly without going through a hub.
- Do not connect USB devices other than a compatible USB keyboard, USB mouse, USB printer, and USB storage to the USB connector for connecting peripheral devices.
- Do not connect multiple printers to the USB connector for connecting peripheral devices.
- Never turn OFF the printer or remove the USB cable while the printer is printing.
- Do not connect or disconnect the USB cable after the power is turned ON until key operation is ready (approximately 20 to 30 s).

**Color**

Select one from the following.

- ON: Prints the image using same colors as the screen (no background color and grid printed in black).
- OFF: Prints the image using the same colors as the image printed using the built-in printer.

**Precautions When Printing with a USB Printer**

- Images may not print properly on some printers. Use USB printers that have been tested for compatibility.
- You can print with a USB printer connected to a computer. In Section 13.8, "Saving Screen Image Data," save the screen image data to a storage medium, read the data into a computer, and then print.

**Note**

---

The DL9000 may not be able to detect "out of paper" and printer errors on the USB printer. If an error occurs, press PRINT again to stop the printing.

---

## 12.4 Printing Using a Network Printer(Optional)

### Procedure

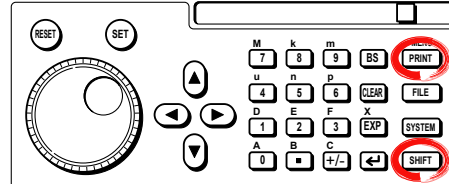

1. Connect the instrument to the network. For details, see section 15.1.

### Selecting a Printer

2. Press **SHIFT+PRINT**.
3. Press the **Copy to** soft key. The printer selection menu appears.
4. Press the **Network Printer** soft key.

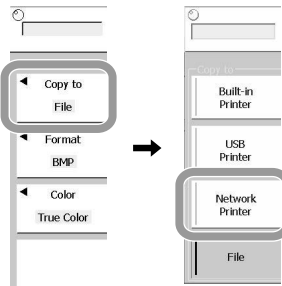

### Setting Up the Connected Printer

5. Press the **Printer** soft key. The supported printers appear.
6. Press the soft key corresponding to connected printer.

### Setting Colors (for Color Printers)

7. Press the **Color** soft key and select ON or OFF.

### Printing

8. Press **PRINT**. The screen is printed on the USB printer.  
To cancel printing, press PRINT again during printing.  
During printing,  is displayed in the lower left part of the screen.

**Explanation**

This function is supported when an Ethernet option (/C8 or /C10) is installed. You can print out an image of the screen on a network printer. Applies to products of firmware version 2.40 or later.

**Connecting to a Network Printer**

The network printer must be set up in advance according to the instructions in section 15.7.

**Supported Printers**

The following printers can be connected.

- HP Inkjet printers

- HP Laser printers (monochrome)

## 13.1 Flash ATA Memory Card

### PC Cards That Can Be Used

The DL9000 supports flash ATA cards (PC card TYPE II) and compact flash (using the PC card TYPE II adapter). In addition, some of the Flash ATA HDD cards can be used. For details, contact your nearest YOKOGAWA dealer.

#### **Note**

Make sure that the PC (personal computer) card that you use is compatible with the PC that you are using. The PC cards mentioned above may not work properly with all PCs. Check it beforehand.

### Inserting the PC Card

With the front side of the PC card facing up, insert the PC card into the drive. There is a PC card drive located on the front panel and the rear panel of the DL9000.

### Ejecting the PC Card

Check that the PC card is not being accessed, and press the PC card eject button to the right of the drive.

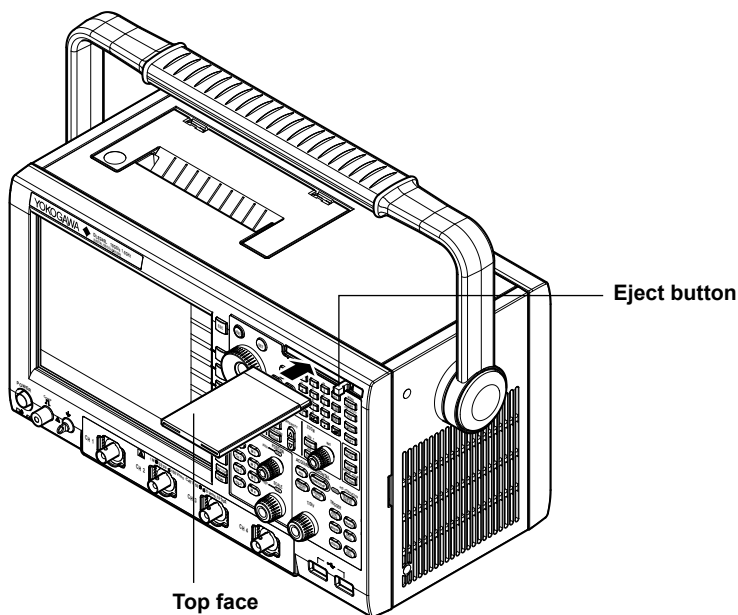

#### **CAUTION**

- The DL9000 may malfunction if the PC card is inserted and ejected within a 1-second time period.
- Removing the PC card while it is being accessed may destroy the data on the PC card.

### General Handling Precautions of PC Cards

For the general handling precautions of the PC card, read the instruction manual that came with the PC card.

## 13.2 Connecting a USB Storage Medium to the USB Port

When connecting a USB storage medium, directly connect the device to the USB port of DL9000 using a USB cable as described below. You can connect/disconnect the USB cable at any time, regardless of the power ON/OFF state of the DL9000 (supports hot-plugging). Connect the type A connector of the USB cable to the DL9000; connect the type B connector to the USB storage. When the power switch is ON, the USB storage is detected and enabled.

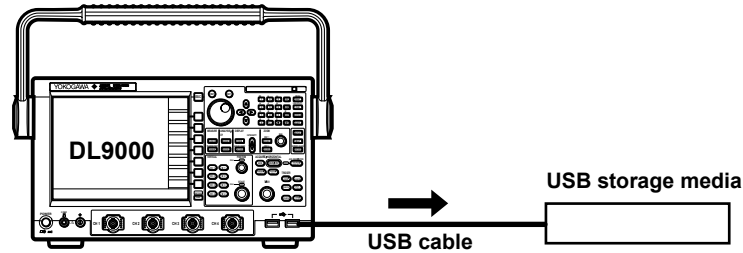

### Note

- Connect the MO disk drive or hard disk directly without going through a USB hub.
- Do not connect USB devices other than a compatible USB keyboard, USB mouse, USB printer, and USB storage to the USB connector for connecting peripheral devices.
- Do not connect and disconnect multiple USB devices in succession. Wait at least 10 seconds between devices.
- Do not connect or disconnect the USB cable after the power is turned ON until key operation is ready (approximately 20 to 30 s).
- USB storage that is compliant with USB Mass Storage Class Ver 1.1 can be used.
- The total number of PC cards and USB storage media that the DL9000 can handle is up to four. If the storage media is partitioned, the total number includes each partition. This is because each partition is handled as a separate storage medium.

### Checking the Connected USB Storage Medium

Press **FILE**. The available media are displayed.



---

## 13.3 Connecting to a Network Drive

You can connect the DL9000 to a network drive for storing and loading data such as setup data, waveform data, analysis data, and screen image data.

For details on connecting the DL9000 to a network drive, see section 15.3, “Saving and Loading Waveform/Setup/Image Data on a Network Drive.”

## 13.4 Saving/Loading the Setup Data

### CAUTION

Do not remove the storage medium (disk) or turn OFF the power when the access indicator is blinking. Doing so can damage the storage medium or destroy the data on the medium.

### Procedure

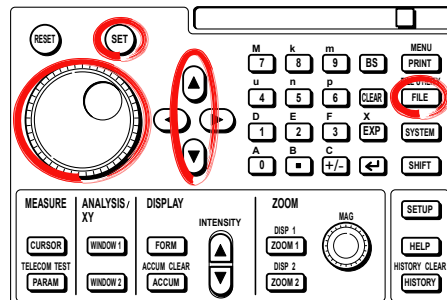

### Saving the Setup Data

1. Press **FILE**.

### Selecting the Save Destination Storage Medium/Directory

2. Using the **rotary knob**, select the save destination storage medium.
3. Press the **Open** soft key to confirm the storage medium.

When saving to a directory in the storage medium, select the directory in the same manner as described above, and then press the **Open** soft key to confirm the directory.

The selected medium/directory is displayed in "Path=....." located in the upper-left of the File List window.

Press the Up soft key to move to the parent directory.

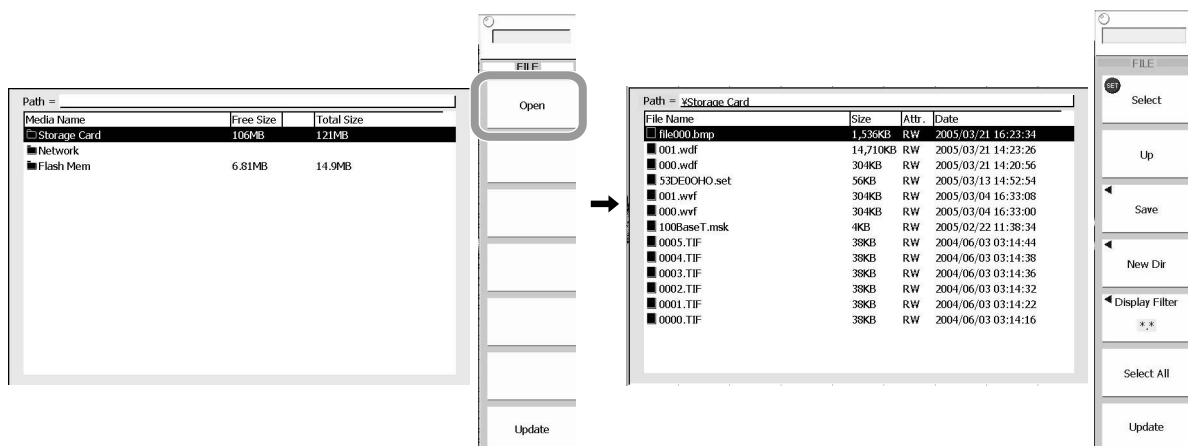

**Setting the Data Type**

4. Press the **Save** soft key. The file name setup menu appears.
5. Press the **Data Type** soft key. A menu used to select the data type appears.
6. Press the **Setup** soft key.

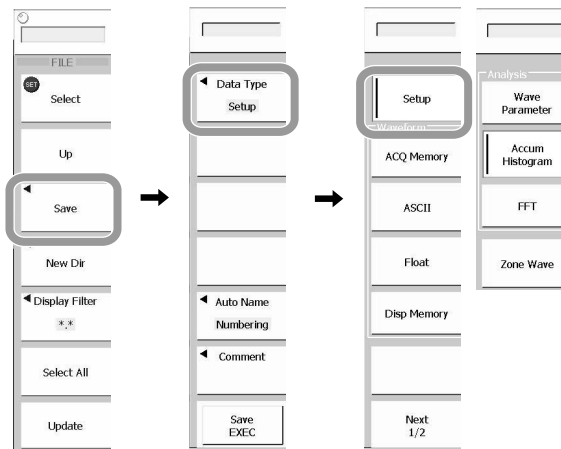

**Setting the File Name**

7. Press the **Auto Name** soft key. A menu used to select the file name setting method appears.
8. Select either **OFF**, **Numbering** or **Date** and then press the corresponding soft key.  
 If you select Date, the date on which the file is saved becomes the file name. If you select Numbering, a sequential number is automatically added after the file name that was specified.  
 If you select Date, proceed to step 12.
9. Press the **File Name** soft key.
10. Enter the file name as described in section 4.2.
11. Press **Enter**. Confirm the file name that was entered.
12. Press **ESC**.

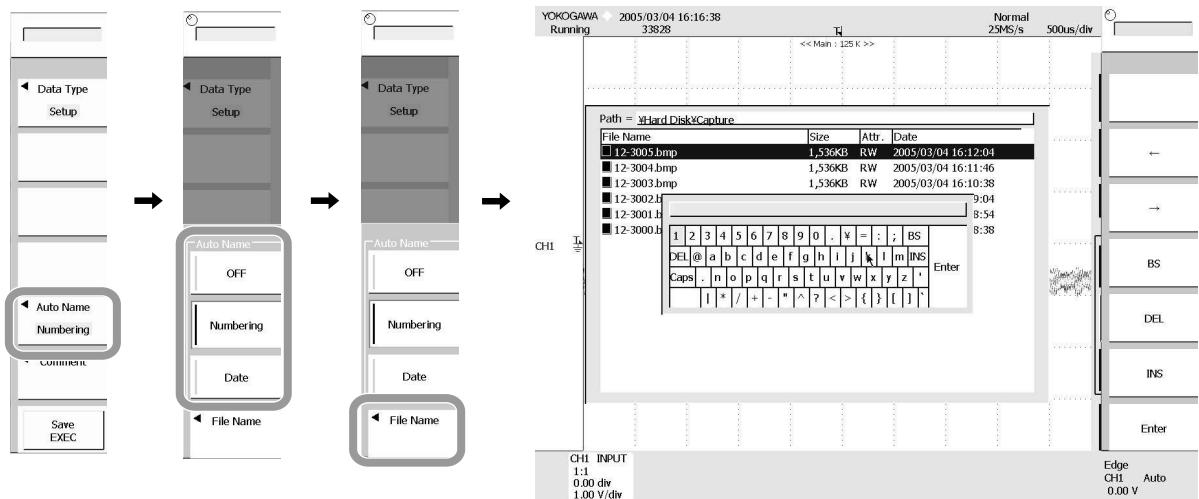

**Setting a Comment**

13. Press the **Comment** soft key.
14. Enter a comment up to 160 characters long as described in section 4.2, and then press Enter.
15. Press **ESC**. Doing so returns you to the previous menu.

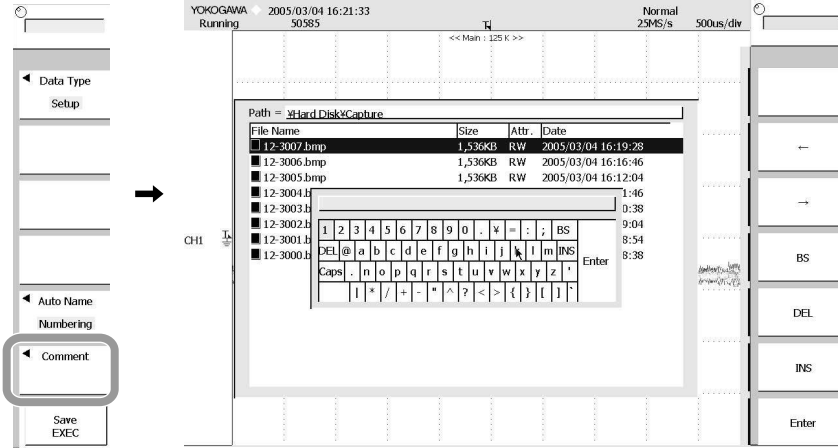

**Executing the Save**

16. Press the **Save Exec** soft key. The data is saved to the directory indicated by Path=..... At the same time, the Save Exec soft key changes to the Abort soft key. While the data is being saved, the media access icon is displayed at the lower left corner of the screen.

**Aborting a Save**

17. Press the **Abort** soft key. The save operation is aborted. At the same time, the Abort soft key changes to the Save EXEC soft key.

**Specifying the Files to Be Displayed in the File List Dialog Box**

You can specify the format of files to be displayed in the file list. Set it as necessary.

18. On a screen that displays the File List dialog box, press the **Display Filter** soft key.
19. Select the extension of the file type that you want to display and then press the corresponding soft key.  
To specify a user-defined file type, press the **User Def** soft key.
20. Press the **Filter** soft key.
21. Enter the file type as described in section 4.2, and then press Enter.

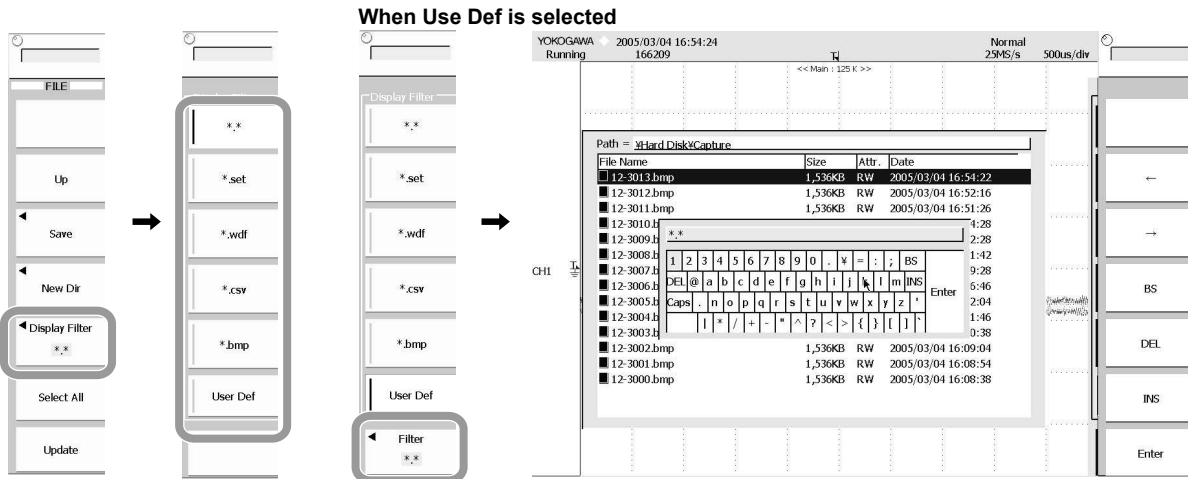

### Loading the Setup Data

1. Press **FILE**.
2. Using the **Up** and **Open** soft keys and the **rotary knob**, select the file to be loaded.
3. Press the **Select** soft key or **SET**. A menu of file operations appears.
4. Press the **Load** soft key.

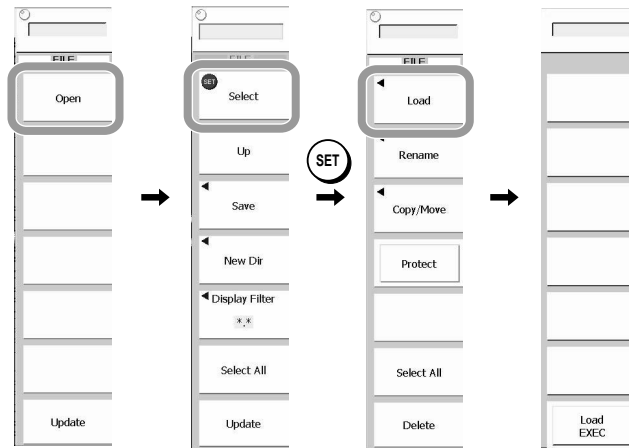

### Executing the Load

5. Press the **Load EXEC** soft key. The selected file is read from the directory indicated in Path=..... At the same time, the Load EXEC soft key changes to the Abort soft key.

### Aborting a Load

6. Press the **Abort** soft key. The load operation is aborted. At the same time, the Abort soft key changes to the Load EXEC soft key.

### Explanation

#### Setup Data That Are Saved

The current setup data can be saved. However, setup data such as the date/time and communications settings are not saved.

#### Number of Bytes Required for a Save

Approx. 64 KB

#### Selecting the Storage Medium and Directory: File

Storage media in which saving and loading are possible are displayed on the File List window.

##### Display Examples of Storage Media

[Flash Mem]: Internal Memory

[Storage Card]: PC card

[HD]: Built-in Hard Disk (Optional)

[NetWork]: Network drive (when the Ethernet interface option is installed)

[USB Storage]: USB Storage

#### Setting the File Name: File Name

The number of characters that can be used for a file or directory name is up to 64 characters from the beginning of the entered characters. However, the following conditions apply.

- The types of characters that can be used are 0 to 9, A to Z, a to z, \_, -, =, (, ), {, }, [, ], #, \$, %, &, ~, !, ', and @ on the keyboard that appears on screen.
- The following character strings cannot be used due to the limitation of MS-DOS. AUX, CON, PRN, NUL, CLOCK, LPT1, LPT2, LPT3, LPT4, LPT5, LPT6, LPT7, LPT8, LPT9, COM1, COM2, COM3, COM4, COM5, COM6, COM7, COM8, and COM9.
- Make sure that the full path name (absolute path name from the root directory) is within 260 characters. If 260 characters is exceeded, an error occurs when you execute a file operation (save, copy, rename, create directory, etc.).
  - Full path name: If you are operating a directory, specify up to the directory name.  
If you are operating a file, specify up to the file name.
- The length of the character string displayed in the entry box of the keyboard that is shown on the screen is 36.

If you use the auto naming function of file names, the following conditions are added.

- If you set auto naming to Numbering, eight-character file names are used consisting of the first five characters entered as the file name and a three-digit serial number.
- If auto naming is set to Date (date/time), the characters entered as the file name are not used. The file name will only consist of the date information.

**Auto Naming Function: Auto Name**

Select one of the following three:

- OFF:** The name specified in File Name is assigned to the file.
- Numbering:** The file is saved with a three-digit number from 000 to 999 that is assigned automatically. You can specify a common name (up to five characters, specified through File Name) that is placed before the number.
- Date:** An 8-character file name based on the date and time is assigned using the numbers 0 to 9 and the letters A to Z as shown below. (Any file name specified for File Name is ignored.)

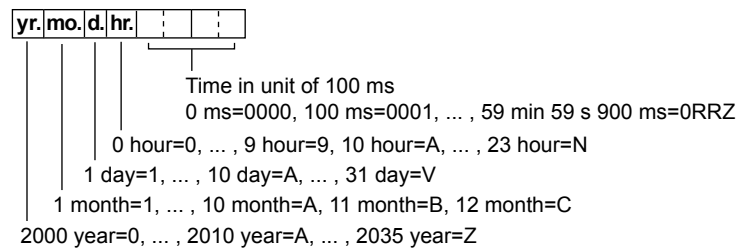
**Setting a Comment: Comment**

A comment of up to 160 characters can be added and saved. Comments are optional. All characters (including spaces) can be used.

**Caution When Saving Data**

A total of 2500 directories and files can be displayed in the file list. If there are more than 2500 directories and files in a single directory, a total of 2500 files and directories will be displayed, but it is not possible to specify which directories and files are displayed.

**Extension for Setup Data**

The .set extension is automatically added to the file name.

**Specifying the Files to Be Displayed in the File List Dialog Box: Display Filter**

Specify the type of files to be displayed.

- \*.set: Displays only setup data files.
- \*.wdf: Displays only waveform files (ACQ Memory).
- \*.csv: Displays only csv files.
- \*.bmp: Displays only bitmap files.
- User Def: Displays files with user-defined content.  
 "\*" and "?" can be used as wildcard characters.
- \*.\*: Displays all the files in the storage medium/directory.

**Note**

- An error occurs if a key other than the Abort key is pressed while saving or loading a file.
- Saving and Loading is not possible while data acquisition is in progress.
- If you change the extension of the file (using a PC, for example), the file can no longer be loaded.
- Up to 36 characters can be displayed in the path.
- If the setup data that is saved to a file is loaded, the settings of the keys are changed to the loaded information and cannot be undone. It is recommended that you first save the current setup data and then load the setup data from a file.
- Setup data concerning the date and time, communications, menu language, message language and USB keyboard language is not saved. Therefore, loading setup data from a file will not change these settings.

## 13.5 Saving/Loading the Measurement Data

### CAUTION

Do not remove the storage medium (disk) or turn OFF the power when the access indicator is blinking. Doing so can damage the storage medium or destroy the data on the medium.

### Procedure

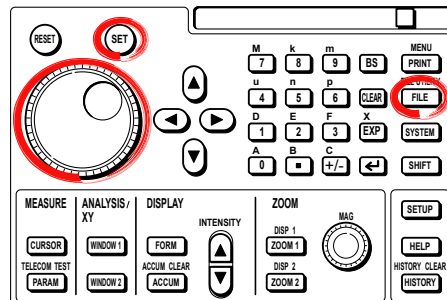

### Saving the Measurement Data

1. Press **FILE**.

### Selecting the Save Destination Storage Media/Directory

2. Use the **rotary knob** to select the save destination storage medium.
3. Press the **Open** soft key to confirm the storage medium.

When saving to a directory in the storage medium, select the directory in the same manner as described above, and then press the **Open** soft key to confirm the directory.

The selected medium/directory is displayed in "Path=....." located in the upper-left of the File List window.

Press the Up soft key to move to the parent directory.

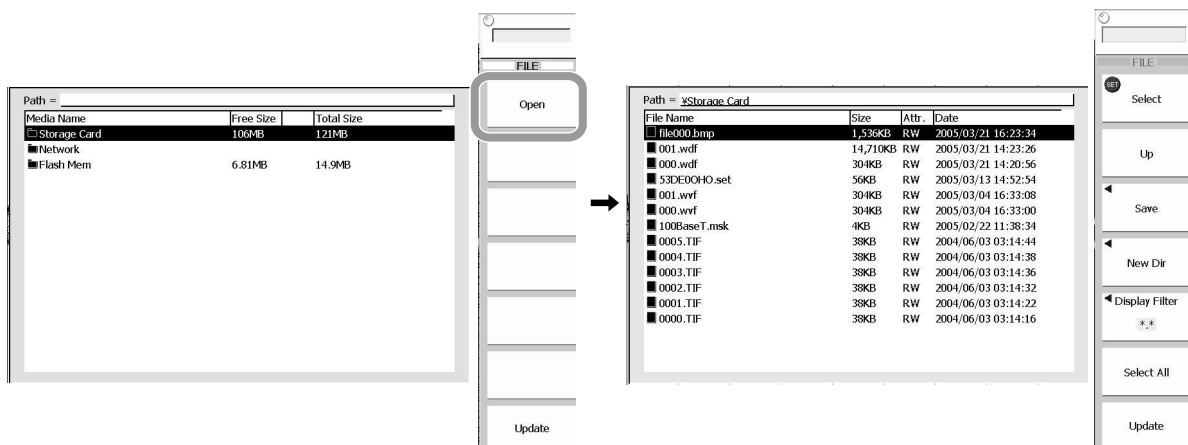



**Setting the Data Type**

4. Press the **Save** soft key. The file name setup menu appears.
5. Press the **Data Type** soft key. A menu used to select the data type appears.
6. Press the **ACQ Memory**, **ASCII** and **Float** soft keys.

**Note**

ACQ Memory data can be saved and loaded, ASCII data and floating point data can only be saved.

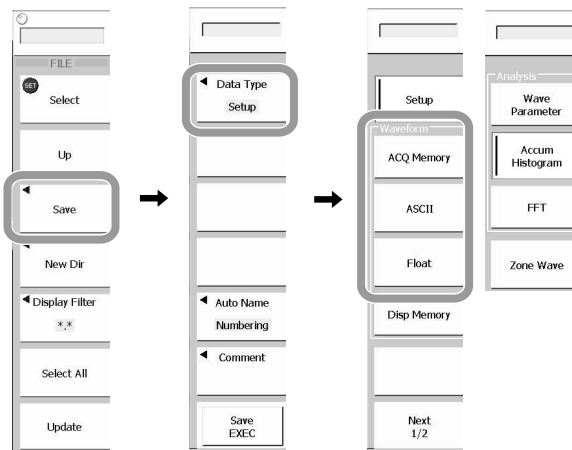

**Selecting a Waveform to be Saved**

7. Press the **Source** soft key. The waveform selection menu appears.
8. Press the soft key corresponding to the channel to be saved to select the waveform to be saved. To specify M1 to M4, first switch to **M1-M4** by pressing the corresponding soft key.

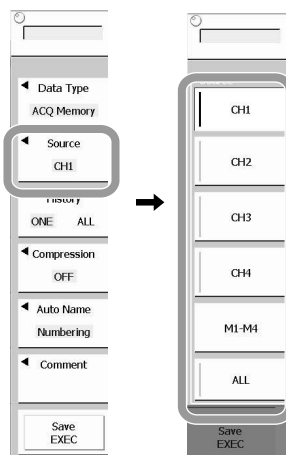

**Selecting the History Waveform**

9. Press the **History** soft key to save all the data in the history memory (ALL) or save only the single displayed waveform (ONE).

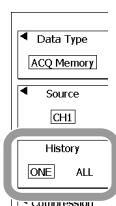

### 13.5 Saving/Loading the Measurement Data

If you select ASCII in step 6 on products with firmware version 3.6 or later, proceed to step 10. Otherwise, proceed to step 14.

#### Selecting the Save Range and Selecting Compression or Decimation (Only if ASCII is selected in step 6 on products with firmware version 3.6 or later)

10. Press the **Compression & Range** soft key.
  11. Press **Main**, **Z1**, or **Z2** soft key to select the waveform to be saved.
  12. To save the data using compression, press the **P-P** soft key. To save the data using decimation, press the **Decim** soft key.
  13. Press **ESC** to return to the previous screen.
- Proceed to step 16.

#### Compressing or Decimating the Data and Saving the Data (On products with firmware version less than 3.6 or if ASCII is not selected on products with firmware version 3.6 or later)

14. Press the **Compression** soft key.
15. To save the data using compression, press the **P-P** soft key. To save the data using decimation, press the **Decim** soft key.
16. Turn the **rotary knob** to set the record length after compression or decimation. The data is compressed or decimated so that the record length is set to the specified value and saved.

Only if ASCII is selected in step 6 on products with firmware version 3.6 or later

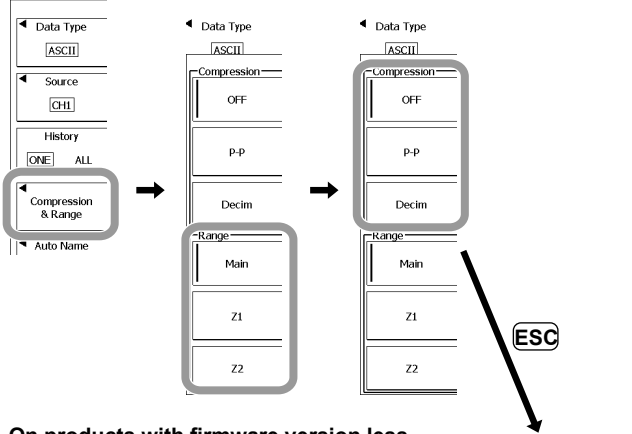

On products with firmware version less than 3.6 or if ASCII is not selected on products with firmware version 3.6 or later

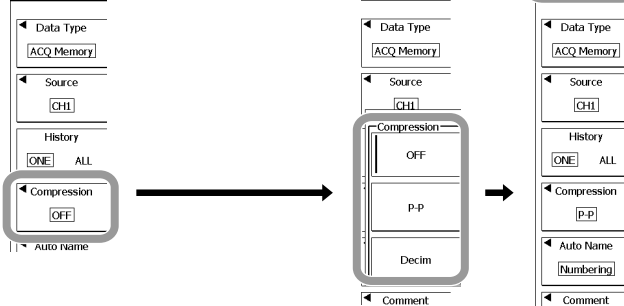

### Setting the File Name

17. Press the **Auto Name** soft key. A menu used to select the file name setting method appears.
18. Select either **OFF**, **Numbering** or **Date** and then press the corresponding soft key.  
If you select Date, the date on which the file is saved becomes the file name. If you select Numbering, a sequential number is automatically added after the file name that was specified.  
If you select Date, proceed to step 22.
19. Press the **File Name** soft key.
20. Enter the file name as described in section 4.2.
21. Press **Enter**. Confirm the file name that was entered.
22. Press **ESC**.

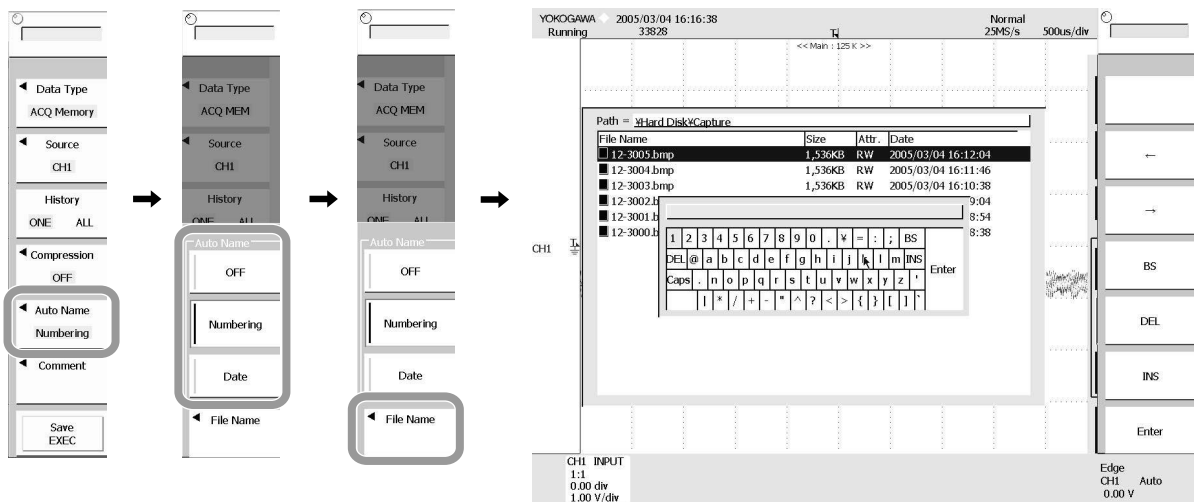

### Setting a Comment

23. Press the **Comment** soft key.
24. Enter a comment up to 160 characters long as described in section 4.2, and then press Enter.
25. Press **ESC** to return to the previous screen.

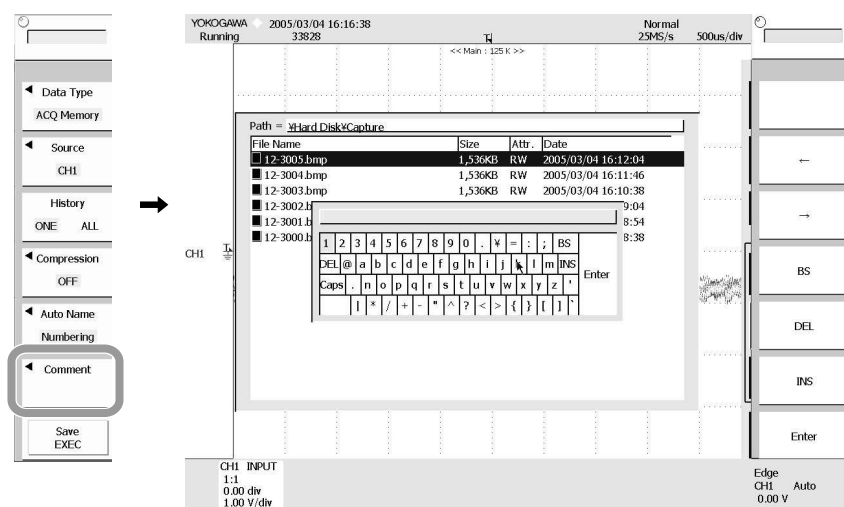

## 13.5 Saving/Loading the Measurement Data

### Executing the Save

26. Press the **Save Exec** soft key. The data is saved to the directory indicated by Path=..... At the same time, the Save Exec soft key changes to the Abort soft key.

While the data is being saved, the file access icon is displayed at the lower left corner of the screen.

### Aborting a Save

27. Press the **Abort** soft key. The save operation is aborted. At the same time, the Abort soft key changes to the Save EXEC soft key.

### Specifying the Files to Be Displayed in the File List Dialog Box

You can specify the format of files to be displayed in the file list. Set it as necessary.

28. On a screen that displays the File List dialog box, press the **Display Filter** soft key.
29. Select the extension of the file type that you want to display and then press the corresponding soft key.  
To specify a user-defined file type, press the **User Def** soft key.
30. Press the **Filter** soft key.
31. Enter the file type as described in section 4.2, and then press Enter.

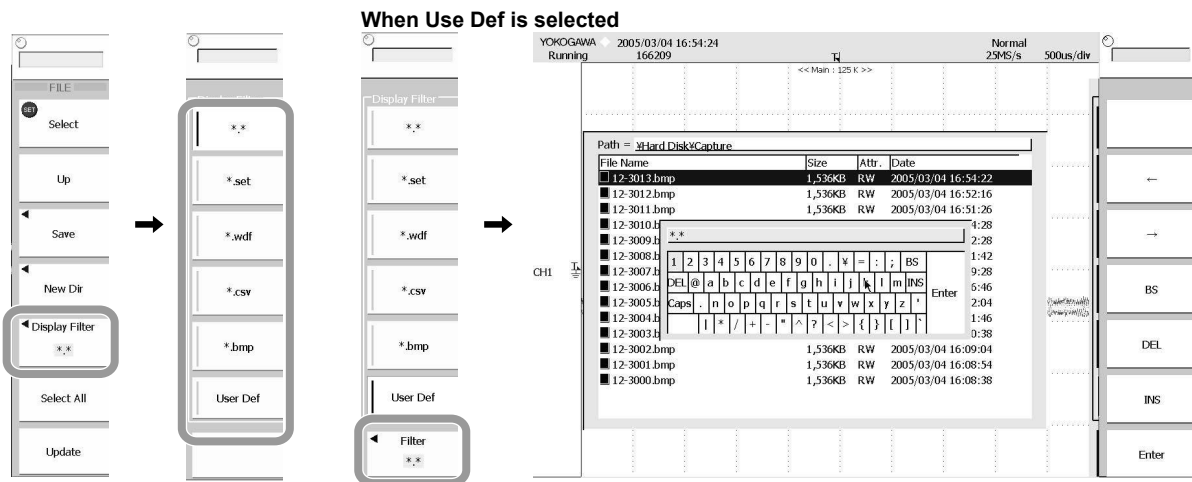

## Loading the Waveform Data

1. Press **FILE**.
2. Using the **Up** and **Open** soft keys and the rotary knob, select the file to be loaded.
3. Press the **Select** soft key or **SET**. A menu of file operations appears.
4. Select the load destination.  
Select ACQ Memory when loading data that was saved with All CH.
5. Press the **Load** soft key.

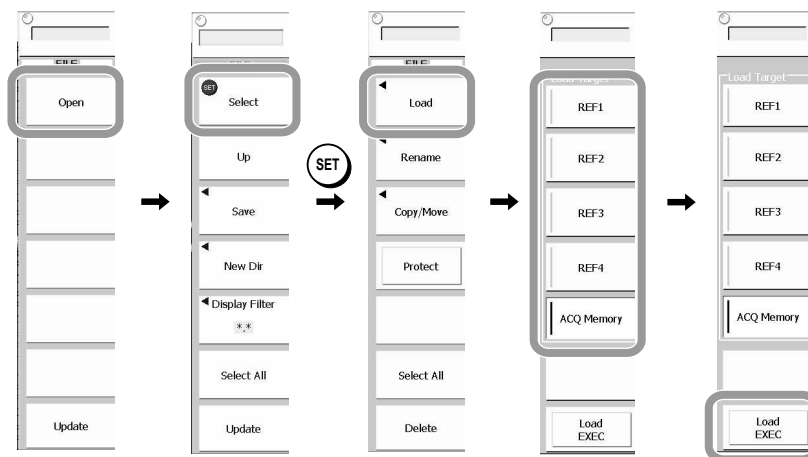

### Selecting the Load Destination

5. Select the acquisition memory (ACQ Memory) or a reference waveform number for the waveform data to be loaded. When a reference waveform number is selected, the waveform data is loaded as a reference waveform. Data saved with All can only be loaded into the acquisition memory.

### Executing the Load

6. Press the **Load EXEC** soft key. The selected file is read from the directory indicated in Path=..... At the same time, the Load EXEC soft key changes to the Abort soft key.

### Aborting a Load

7. Press the **Abort** soft key. The load operation is aborted. At the same time, the Abort soft key changes to the Load EXEC soft key.

**Explanation**

**Selecting the Data Type: Data Type**

- **ACQ Memory**
  - The sampled data in the acquisition memory is saved in binary format.
  - The data that is saved can be loaded into the DL9000. Then, the DL9000 can display the waveform and compute the numeric data.
  - You can use the Xviewer software application by YOKOGAWA to analyze waveforms on a PC. For details, contact your nearest YOKOGAWA dealer. A trial version is available at the YOKOGAWA's Website.
  - The extension is .wdf.
  
- **ASCII**
  - The units of the sampled data in the acquisition memory are converted per the specified range and saved in ASCII format. The data can be used to analyze the waveform on a PC.
  - The file cannot be loaded into the DL9000.
  - The extension is .csv.
  
- **Float**
  - The units of the sampled data in the acquisition memory are converted per the specified range and saved in 32-bit floating format. The data can be used to analyze the waveform on a PC.
  - The order of the data is little-endian (Intel format).
  - The file cannot be loaded into the DL9000.
  - The extension is .fld.

**Data Size**

The following table shows the data size when the record length is set to 125 kW, waveform data of CH1 to CH4 are saved, and using history waveform 1 condition.

Data Type	Extension	Data Size (Bytes)
ACQ Memory	.wdf	Approx. 1 M ((125 kW + 12) × 4 channels × the number of history waveforms × 2 + 70 K)
ASCII	.csv	9 to 10 M
Float	.fld	Approx. 2 M (((125 kW + 12) × 4) × the number of history waveforms × 4)

**Waveforms to Be Saved: Source**

- You can save all waveforms or the selected displayed among CH1 to CH4, M1 to M4, and LOGIC.
- The setup data including vertical axis, horizontal axis, and trigger of the waveform to be saved is also saved.
- For waveforms that are loaded using the history memory function, you can select whether to save all of the history data, or save just the current displayed waveform on the screen. You can also save only the results obtained by searching the history memory data. For details on searching history memory data, see Chapter 11.
- If you select all waveforms, the displayed waveforms among CH1 to CH4, M1 to M4, and LOGIC are saved. However, computed waveforms that use CH2 or CH4 as sources cannot be saved in interleave mode.

**Compressing and Saving Data: P-P**

You can select whether to P-P compress the waveform data before saving. The data that has been compressed and saved cannot be loaded to the acquisition memory of the DL9000.

**Selecting the Compressed Size**

You can select the compressed size from among the following.  
2.5 k, 6.25 k, 12.5 k, 62.5 k, 125 k, 250 k, 625 k, 1.25 M, 2.5 M, 6.25 M  
If the record length and the compressed size are the same, the data is saved without compression.

**Decimating and Saving Data: Decim**

Saves the data by decimating the data.  
The data that has been decimated and saved cannot be loaded to the acquisition memory of the DL9000.

**Selecting the Storage Medium and Directory**

Storage media in which saving and loading are possible are displayed on the File List window.

**Display Examples of Storage Media**

Same as the explanation given in "Display Examples of Storage Media" of section 13.4.

**Setting the File Name: File Name**

Same as the explanation given in "Setting the File Name" in section 13.4.

**Setting a Comment: Comment**

Same as the explanation given in "Setting a Comment" in section 13.4.

**Specifying the Files to Be Displayed in the File List Dialog Box: Display Filter**

Specify the type of files to be displayed.  
Same as the explanation given in "Specifying the Files to Be Displayed in the File List Dialog Box" in section 13.4.

**Note**

- An error occurs if a key other than the Abort key is pressed while saving or loading a file. When waveform data is loaded, the accumulation setting is always OFF.
- If you change the extension of the saved data (using a PC, for example), the file can no longer be loaded.
- A total of 2500 directories and files can be displayed in the file list. If there are more than 2500 directories and files in a single directory, a total of 2500 files and directories will be displayed, but it is not possible to specify which directories and files are displayed.

## 13.5 Saving/Loading the Measurement Data

### Data Format When Storing Multiple Records

When multiple records are stored (history memory, for example), the following data format is used.

#### ASCII Format: CR+LF is inserted between records.

<Header>

Measured data 1-1 of CH1, Measured data 1-1 of CH2, Measured data 1-1 of CH3, ... , [CR+LF]

Measured data 1-2 of CH1, Measured data 1-2 of CH2, Measured data 1-2 of CH3, ... , [CR+LF]

⋮

Measured data 1-m of CH1, Measured data 1-m of CH2, Measured data 1-m of CH3, ... , [CR+LF]

[CR+LF]

Measured data 2-1 of CH1, Measured data 2-1 of CH2, Measured data 2-1 of CH3, ... , [CR+LF]

Measured data 2-2 of CH1, Measured data 2-2 of CH2, Measured data 2-2 of CH3, ... , [CR+LF]

⋮

Measured data 2-n of CH1, Measured data 2-n of CH2, Measured data 2-n of CH3, ... , [CR+LF]

[CR+LF]

⋮

Record 1

Record 2

#### Float Format: Stored in blocks of channels.

Measured data of record 1 of CH1
Measured data of record 2 of CH1
⋮
Measured data of record N of CH1
Measured data of record 1 of CH2
Measured data of record 2 of CH2
⋮
Measured data of record N of CH2
⋮

### Loading Measurement Data

Measurement data saved on a storage media or in internal memory can be loaded and displayed. Reference waveforms or the acquisition memory can be used as the load destination. Data that was saved with the Source set to ALL cannot be loaded as a reference waveform. Also, data that has been compressed for storage cannot be loaded into the acquisition memory.

When waveform acquisition is started, any data loaded into the acquisition memory will be overwritten.



## 13.6 Saving/Loading the Accumulated Waveforms

### CAUTION

Do not remove the storage medium (disk) or turn OFF the power when the access indicator is blinking. Doing so can damage the storage medium or destroy the data on the medium.

### Procedure

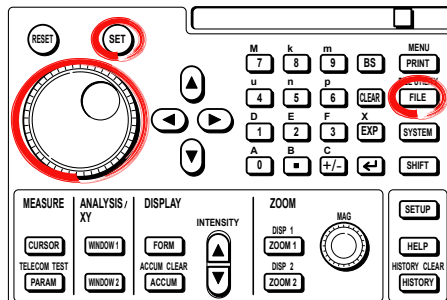

### Saving Accumulated Waveforms

1. Press **FILE**.

### Selecting the Save Destination Storage Media/Directory

2. Use the **rotary knob** to select the save destination storage medium.
3. Press the **Open** soft key to confirm the storage medium.

When saving to a directory in the storage medium, select the directory in the same manner as described above, and then press the **Open** soft key to confirm the directory.

The selected medium/directory is displayed in "Path=....." located in the upper-left of the File List window.

Press the Up soft key to move to the parent directory.

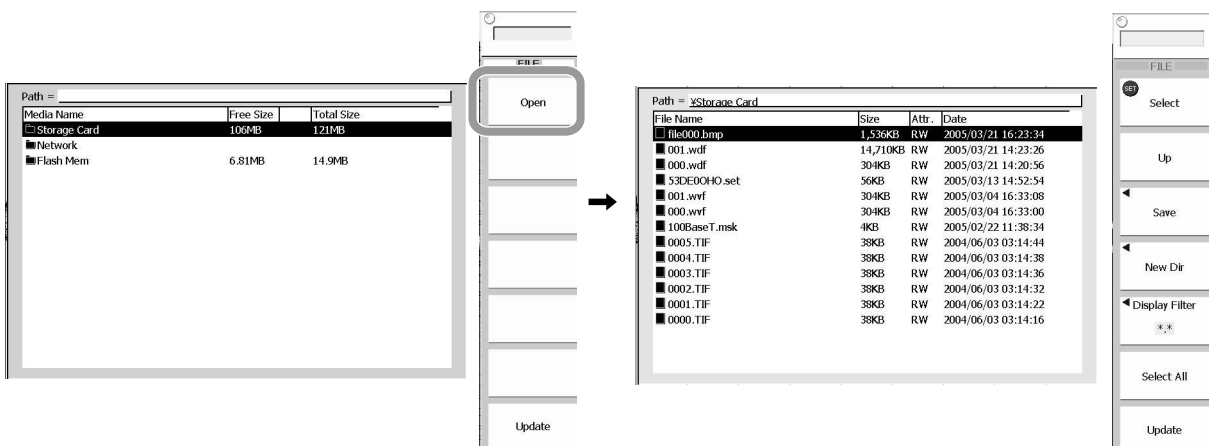

## 13.6 Saving/Loading the Accumulated Waveforms

### Setting the Data Type

4. Press the **Save** soft key. The file name setup menu appears.
5. Press the **Data Type** soft key. A menu used to select the data type appears.
6. Press the **Disp Memory** soft key.

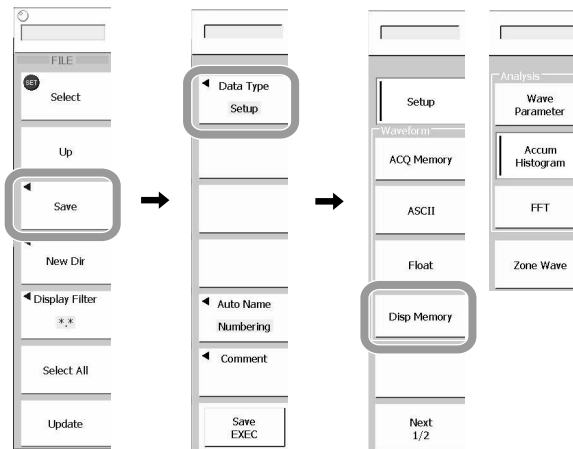

### Selecting a Waveform to be Saved

7. Press the **Source** soft key. The waveform selection menu appears.
8. Press the soft key corresponding to the channel to be saved to select the waveform to be saved. To specify M1 to M4, first switch to **M1-M4** by pressing the corresponding soft key.

To save the XY display of an accumulated waveform, first switch to XY1 to XY2 by pressing the **XY1-XY2** soft key and then specify the soft key corresponding to the desired storage location.

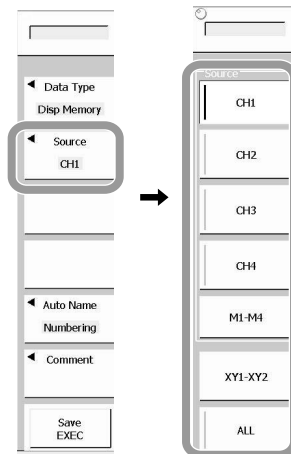

**Setting the File Name**

9. Press the **Auto Name** soft key. A menu used to select the file name setting method appears.
10. Select either **OFF**, **Numbering** or **Date** and then press the corresponding soft key.  
 If you select Date, the date on which the file is saved becomes the file name. If you select Numbering, a sequential number is automatically added after the file name that was specified.  
 If you select Date, proceed to step 14.
11. Press the **File Name** soft key.
12. Enter the file name as described in section 4.2.
13. Press **Enter**. Confirm the file name that was entered.
14. Press **ESC**.

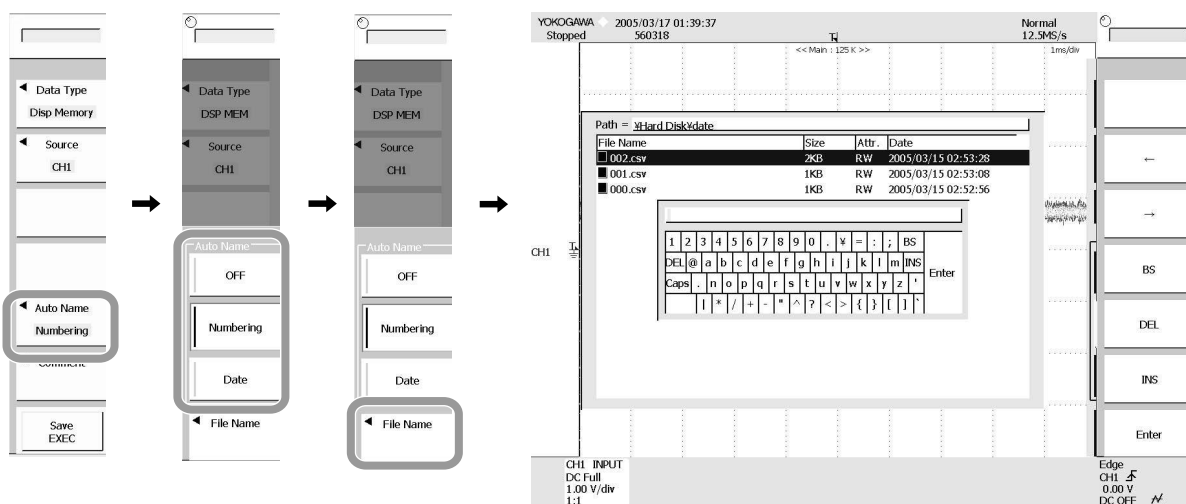

**Setting a Comment**

15. Press the **Comment** soft key.
16. Enter a comment up to 160 characters long as described in section 4.2, and then press Enter.
17. Press **ESC**. Doing so returns you to the previous menu.

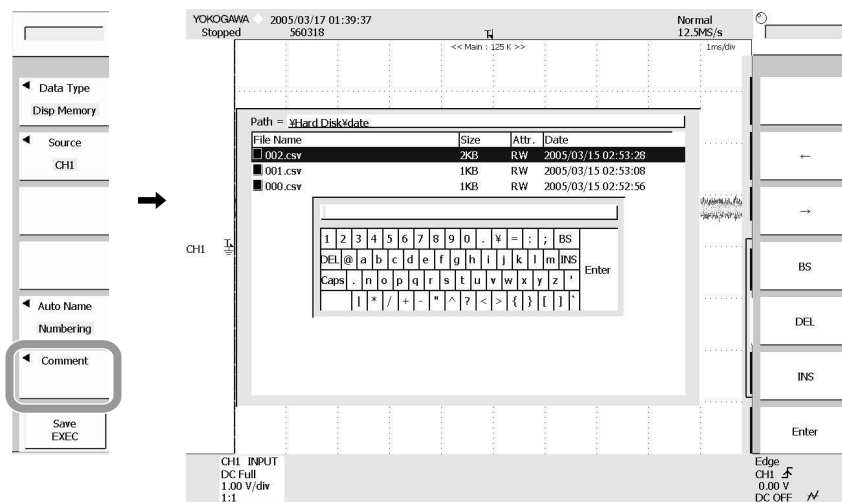

## 13.6 Saving/Loading the Accumulated Waveforms

---

### Executing the Save

18. Press the **Save Exec** soft key. The data is saved to the directory indicated by Path=..... At the same time, the Save Exec soft key changes to the Abort soft key.  
While the data is being saved, the file access icon is displayed at the upper left corner of the screen.

### Aborting a Save

19. Press the **Abort** soft key. The save operation is aborted. At the same time, the Abort soft key changes to the Save EXEC soft key.

### Specifying the Files to Be Displayed in the File List Dialog Box

You can specify the format of files to be displayed in the file list. Set it as necessary.

20. Set the extension for the file displayed in the File List dialog box according to the procedure described on pages 13-6.

## Loading the Accumulated Waveform

1. Press **FILE**.
2. Using the **Up** and **Open** soft keys and the rotary knob, select the file to be loaded.
3. Press the **Select** soft key or **SET**. A menu of file operations appears.
4. Press the **Load** soft key.

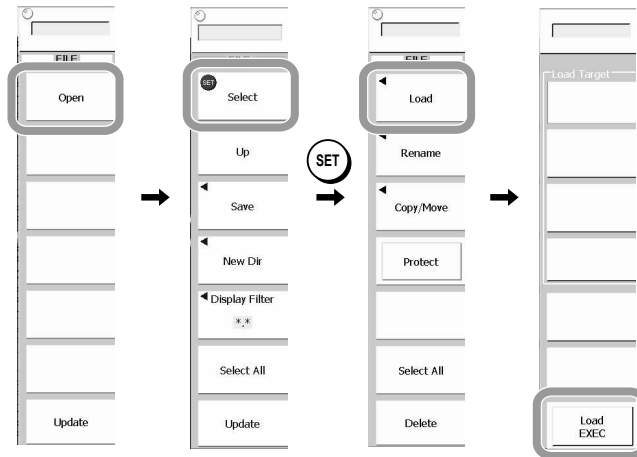

### Executing the Load

5. Press the **Load EXEC** soft key. The selected file is read from the directory indicated in Path=..... At the same time, the Load EXEC soft key changes to the Abort soft key.

### Aborting a Load

6. Press the **Abort** soft key. The load operation is aborted. At the same time, the Abort soft key changes to the Load EXEC soft key.

## Explanation

### Selecting the Storage Medium and Directory

Storage media in which saving and loading are possible are displayed on the File List window.

#### Display Examples of Storage Media

Same as the explanation given in "Display Examples of Storage Media" of section 13.4.

## 13.6 Saving/Loading the Accumulated Waveforms

---

### **Setting the File Name: File Name**

Same as the explanation given in “Setting the File Name” in section 13.4.

### **Setting a Comment: Comment**

Same as the explanation given in “Setting a Comment” in section 13.4.

### **Specifying the Files to Be Displayed in the File List Dialog Box: Display Filter**

Specify the type of files to be displayed.

Same as the explanation given in “Specifying the Files to Be Displayed in the File List Dialog Box” in section 13.4.

### ***Note***

---

- An error occurs if a key other than the Abort key is pressed while saving or loading a file.
  - When waveform data is loaded, the accumulate setting is always OFF.
  - If you change the extension of the saved data (using a PC, for example), the file can no longer be loaded.
  - A total of 2500 directories and files can be displayed in the file list. If there are more than 2500 directories and files in a single directory, a total of 2500 files and directories will be displayed, but it is not possible to specify which directories and files are displayed.
-

# 13.7 Saving/Loading Waveform Zones, Polygon Zones, and Mask Patterns

## CAUTION

Do not remove the storage medium (disk) or turn OFF the power when the access indicator is blinking. Doing so can damage the storage medium or destroy the data on the medium.

### Procedure

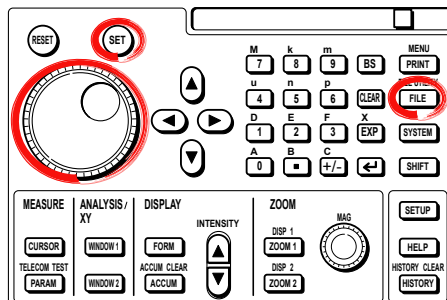

### Saving a Zone

1. Press **FILE**.

#### Selecting the Save Destination Storage Media/Directory

2. Use the **rotary knob** to select the save destination storage medium.
3. Press the **Open** soft key to confirm the storage medium.

When saving to a directory in the storage medium, select the directory in the same manner as described above, and then press the **Open** soft key to confirm the directory.

The selected medium/directory is displayed in "Path=....." located in the upper-left of the File List window.

Press the Up soft key to move to the parent directory.

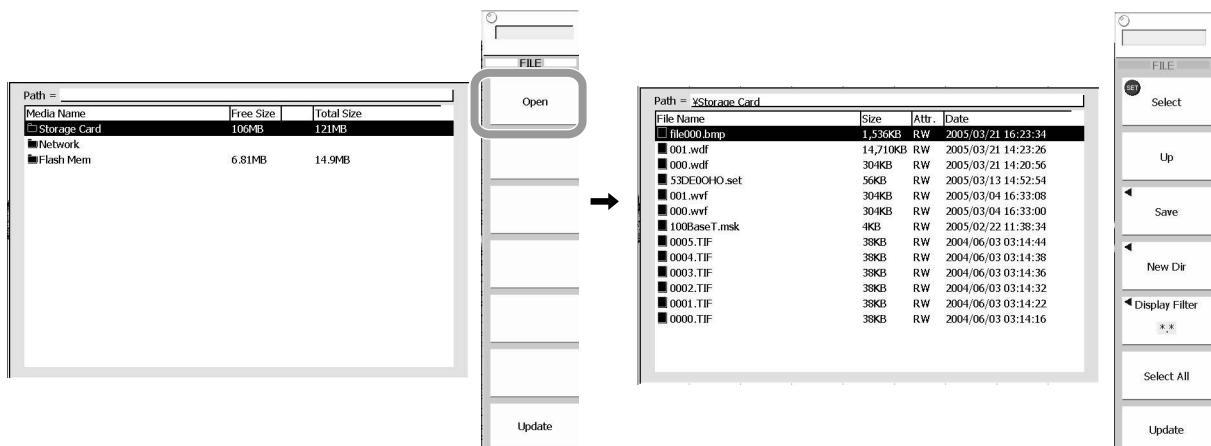

## 13.7 Saving/Loading Waveform Zones, Polygon Zones, and Mask Zones

### Setting the Data Type

4. Press the **Save** soft key. The file name setup menu appears.
5. Press the **Data Type** soft key. A menu used to select the data type appears.
6. Press the **Next 1/2** soft key.
7. Press the **Zone Wave** soft key.

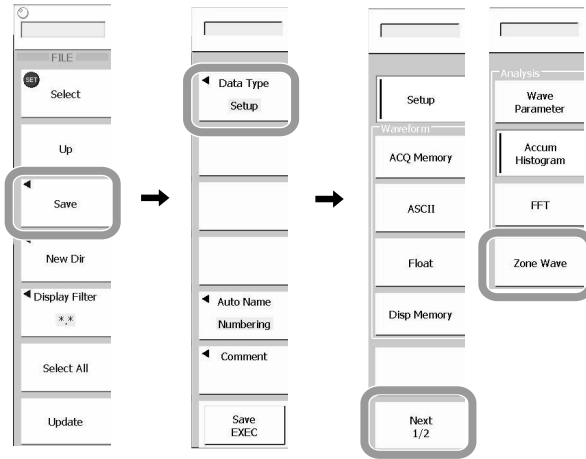

### Selecting a Zone To Be Saved

8. Press the **Zone** soft key. A menu for selecting the zone appears.
9. Select the zone to be saved by pressing the soft key that corresponds to the zone number that is set for that zone.

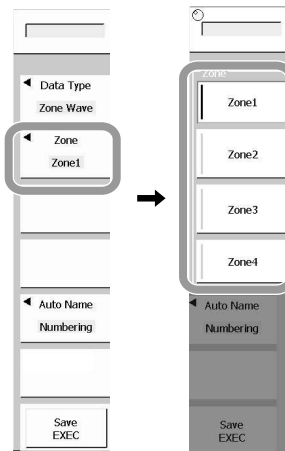



**Setting the File Name**

10. Press the **Auto Name** soft key. A menu used to select the file name setting method appears.
11. Select either **OFF**, **Numbering** or **Date** and then press the corresponding soft key.  
 If you select Date, the date on which the file is saved becomes the file name. If you select Numbering, a sequential number is automatically added after the file name that was specified.  
 If you select Date, proceed to step 15.
12. Press the **File Name** soft key.
13. Enter the file name as described in section 4.2.
14. Press **Enter**. Confirm the file name that was entered.
15. Press **ESC**.

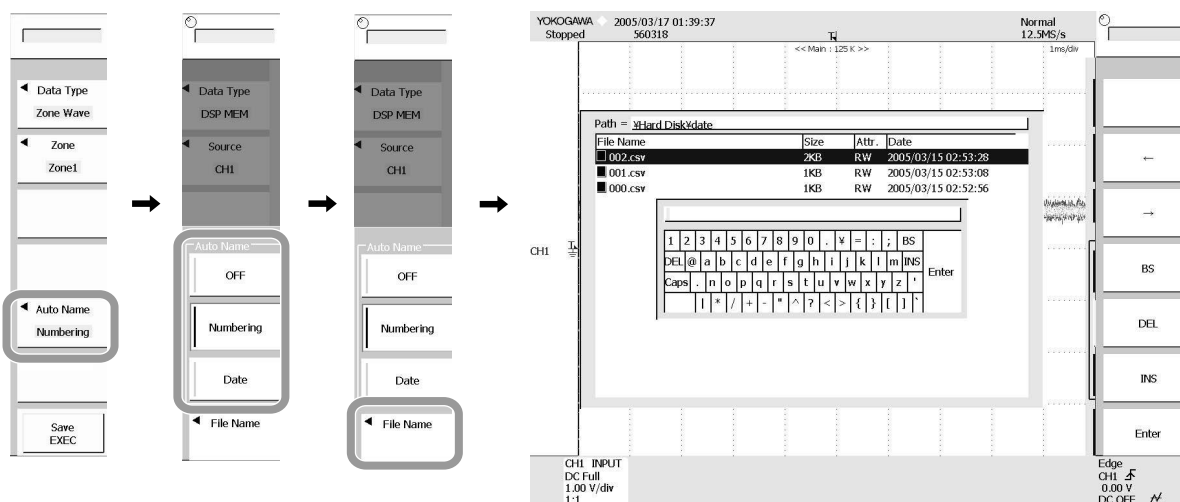

**Executing the Save**

16. Press the **Save Exec** soft key. The data is saved to the directory indicated by Path=..... At the same time, the Save Exec soft key changes to the Abort soft key.  
 While the data is being saved, the file access icon is displayed at the upper left corner of the screen.

**Aborting a Save**

17. Press the **Abort** soft key. The save operation is aborted. At the same time, the Abort soft key changes to the Save EXEC soft key.

**Specifying the Files to Be Displayed in the File List Dialog Box**

- You can specify the format of files to be displayed in the file list. Set it as necessary.
18. Set the extension for the file displayed in the File List dialog box according to the procedure described on pages 13-6.

**Loading the Waveform Zone**

1. Press **FILE**.
2. Using the **Up** and **Open** soft keys and the rotary knob, select the file to be loaded.
3. Press the **Select** soft key or **SET**. A menu of file operations appears.
4. Press the **Load** soft key.

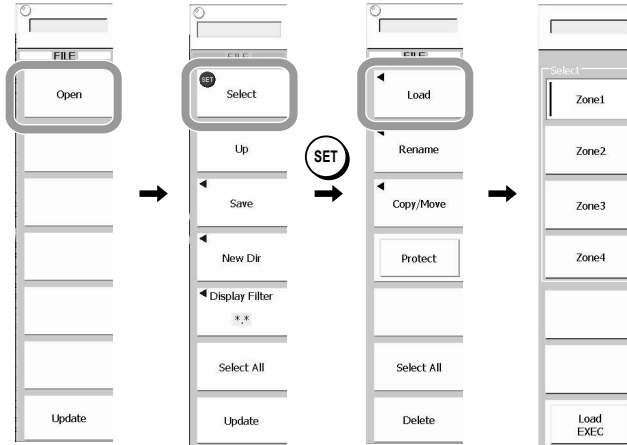

**Selecting the Load Destination**

5. Select the number for the zone to be loaded.

**Executing the Load**

6. Press the **Load EXEC** soft key. The selected file is read from the directory indicated in Path=..... At the same time, the Load EXEC soft key changes to the Abort soft key.

**Aborting a Load**

7. Press the **Abort** soft key. The load operation is aborted. At the same time, the Abort soft key changes to the Load EXEC soft key.

**Loading the Polygon Zone or Mask Pattern**

1. Select the file to be loaded in the same manner as for Loading the Waveform Zone above.
2. Press **Select** soft key or **SET**. A menu of file operations appears.
3. Press the **Load** soft key.

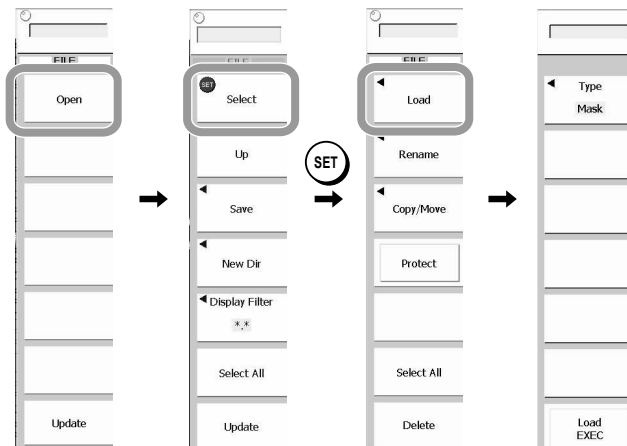

**Selecting the Data Type**

4. Press the **Type** soft key. A menu used to select the data type appears.
5. Select either **Zone Polygon** or **Mask**.
6. If Zone Polygon was selected in step 5, select the number of the zone to be loaded.

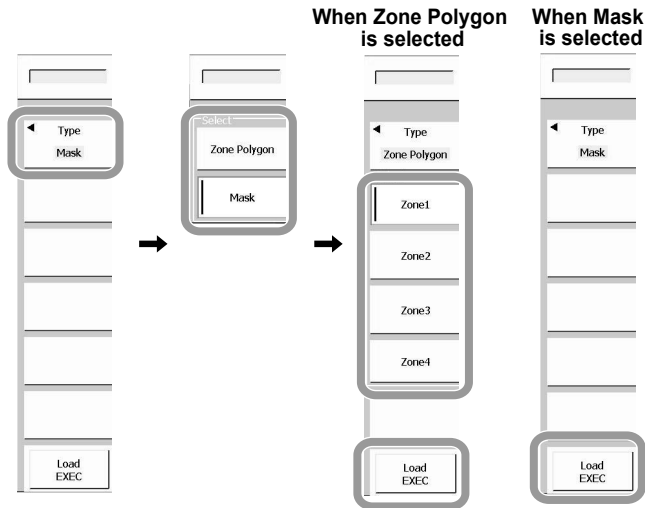

**Executing the Load**

7. Press the **Load EXEC** soft key. The selected file is read from the directory indicated in Path=..... At the same time, the Load EXEC soft key changes to the Abort soft key.

**Aborting a Load**

8. Press the **Abort** soft key. The load operation is aborted. At the same time, the Abort soft key changes to the Load EXEC soft key.

**Explanation**

You can search for GO/NO-GO determination and history waveform, and save and load waveform zones that are used for zoom and search. The waveform zone can be saved in Zone 1 through Zone 4.

**Savable waveform zones**

Waveform zones

**Loadable zones and pattern**

Waveform zones, polygon zones, and mask patterns

**Data Extension**

Waveform zones: .ZWF

Mask patterns; polygon zones: .MSK

**Note**

Pressing a key other than the Abort key while the save is in progress will cause an error.

## 13.8 Saving Screen Image Data

### Procedure

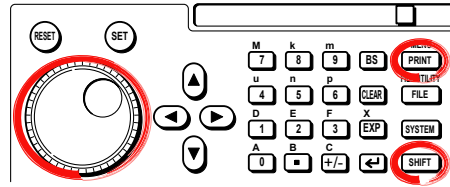

1. Press the **SHIFT + PRINT** key. The file menu appears.
2. Press the **Copy to** soft key.
3. Press the **File** soft key.

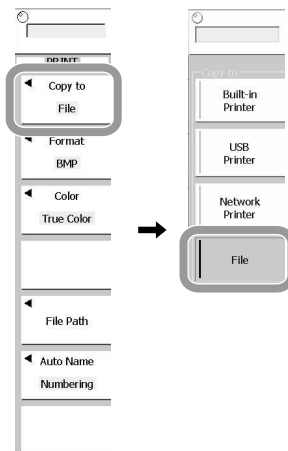

### Selecting the Data Format

4. Press the **Format** soft key.
5. Select either **BMP**, **PNG**, or **JPEG** and then press the corresponding soft key.

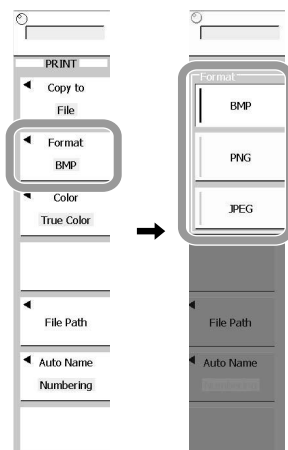

### Selecting the Color Mode

6. Press the **Color** soft key.
7. Press the soft key that corresponds to the desired color mode selection.

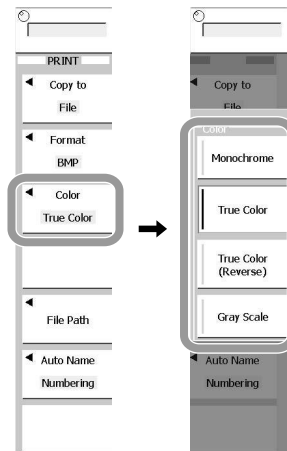

### Selecting the Save Destination

8. Press the **File Path** soft key.
9. Use the **rotary knob** to select the storage medium and directory where the data is to be saved and then press the **OPEN** soft key.  
You can move to the parent directory by pressing the Up soft key.
10. Press **ESC**.

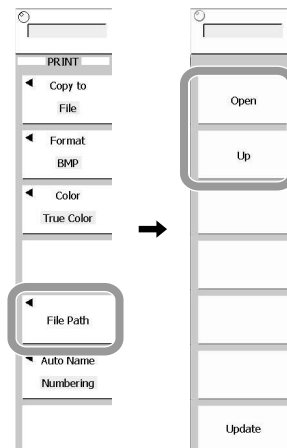

## 13.8 Saving Screen Image Data

### Setting the File Name

11. Press the **Auto Name** soft key.
12. Select either **OFF**, **Numbering** or **Date** and then press the corresponding soft key.  
If you select Date, proceed to step 15.
13. Press the **File Name** soft key.
14. Enter the file name as described in section 4.2.
15. Press **ESC**.

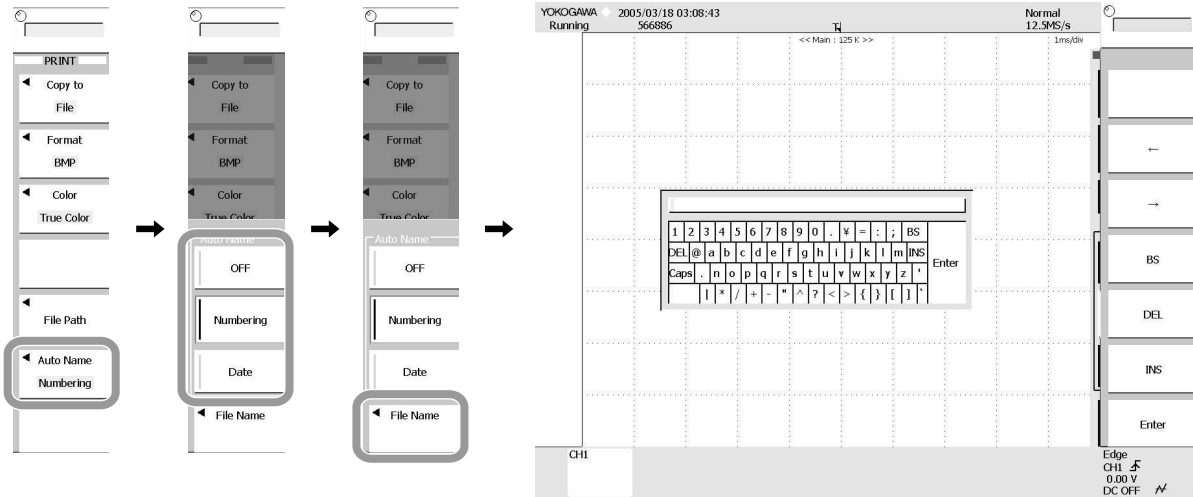

### Executing the Save Operation

16. When a screen that you want to save is displayed, press **PRINT**.  
The screen image data is saved in the specified save destination.

**Explanation**

The screen image data can be stored in a specified storage medium. A PC card, external USB device, internal hard drive (optional), or network drive (when the optional Ethernet interface is installed) can be selected as the storage medium. For details on saving data to the network drive see section 15.3.

**Data Format and Extension**

Data in the following formats can be saved to a specified storage medium. The extension that is automatically attached and the data size (reference value) are indicated below.

Data Format	Extension	Data Size <sup>1</sup>
BMP	.bmp	Approximately 100 KB (approximately 1.6 MB) <sup>2</sup>
PNG	.png	Approximately 11 KB (approximately 52 KB) <sup>2</sup>
JPG	.jpg	Approximately 255 KB <sup>3</sup>

1 For monochrome data

2 The file size indicated in parentheses is the size for True Color data.

3 When saved in JPG format, all data are about the same size.

**Color Mode**

You can select the color mode.

True Color	Output using 65536 colors.
True Color(Reverse)	Do not output the background of the screen in color.
Gray Scale	Output the data using a tint of 32 gray levels.
Monochrome	Output in black and white. This mode cannot be selected with JPG format.

**Save Destination**

The available storage medium is displayed in the File List window.

**Display Examples of Storage Media**

Same as the explanation given in “Display Examples of Storage Media” of section 13.4.

**Setting the File Name:File Name**

Same as the explanation given in “Setting the File Name” in section 13.4.

**Note**

A total of 2500 directories and files can be displayed in the file list. If there are more than 2500 directories and files in a single directory, a total of 2500 files and directories will be displayed, but it is not possible to specify which directories and files are displayed.

## 13.9 Saving Analysis Results

### Procedure

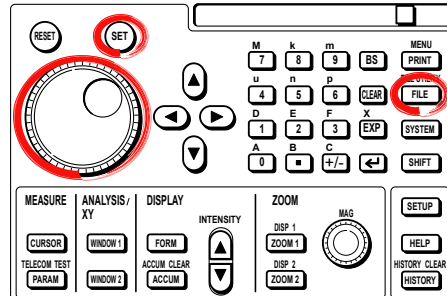

1. Press **FILE**.

### Selecting the Save Destination Storage Media/Directory

2. Use the **rotary knob** to select the save destination storage medium.
3. Press the **Open** soft key to confirm the storage medium.

When saving to a directory in the storage medium, select the directory in the same manner as described above, and then press the **Open** soft key to confirm the directory.

The selected medium/directory is displayed in "Path=....." located in the upper-left of the File List window.

Press the Up soft key to move to the parent directory.

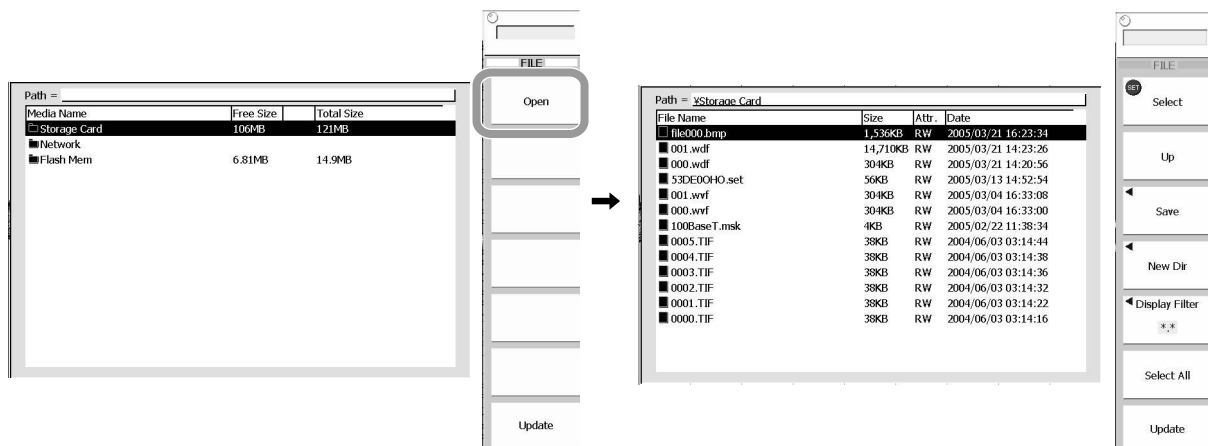



**Setting the Data Type**

4. Press the **Save** soft key. The file name setup menu appears.
5. Press the **Data Type** soft key. A menu used to select the data type appears.
6. Press the **Next 1/2** soft key.
7. Press either the **Wave Parameter**, **Accum Histogram** or **FFT** soft key.

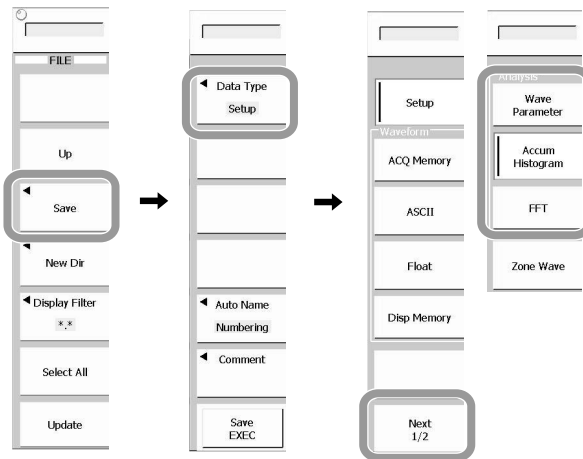

**Setting the File Name**

8. Press the **Auto Name** soft key. A menu used to select the file name setting method appears.
9. Select either **OFF**, **Numbering** or **Date** and then press the corresponding soft key.  
If you select Date, the date on which the file is saved becomes the file name. If you select Numbering, a sequential number is automatically added after the file name that was specified.  
If you select Date, proceed to step 13.

10. Press the **File Name** soft key.
11. Enter the file name as described in section 4.2.
12. Press **Enter**. Confirm the file name that was entered.
13. Press **ESC**.

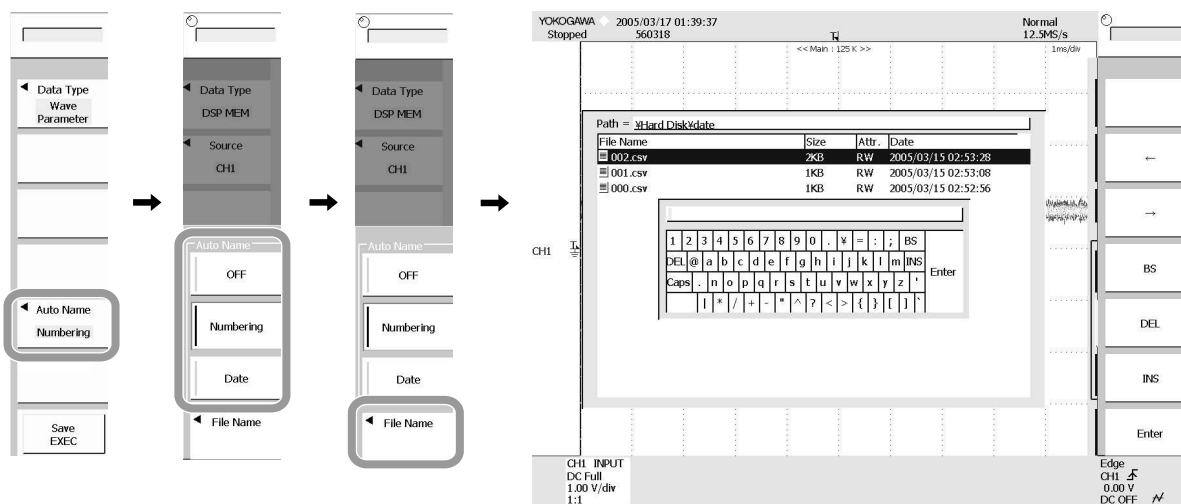

### Executing the Save

14. Press the **Save Exec** soft key. The data is saved to the directory indicated by Path=..... At the same time, the Save Exec soft key changes to the Abort soft key.  
While the data is being saved, the file access icon is displayed at the upper left corner of the screen.

### Aborting a Save

15. Press the **Abort** soft key. The save operation is aborted. At the same time, the Abort soft key changes to the Save EXEC soft key.

### Specifying the Files to Be Displayed in the File List Dialog Box

You can specify the format of files to be displayed in the file list. Set it as necessary.

16. Set the extension for the file displayed in the File List dialog box according to the procedure described on pages 13-6.

**Explanation**

The analysis results are stored in CSV format in the specified storage medium. The extension is .CSV. A CSV-format data file is a comma-delimited, text-based file. It is one common data format that is used for sharing data among different spreadsheet and database applications.

A PC card, external USB device, or network drive (when the optional Ethernet interface is installed) can be selected as the storage medium.

**Data Type: Data Type**

Select one of the following three data types.

**Wave Parameter:** Saves the measured results for items specified for automatic measurement of waveform parameters. (See section 10.2 and section 10.3.)

**Accum Histogram:** Saves a histogram of the distribution frequency of the specified region. (See section 10.8.)

**FFT:** Saves the results of the FFT operation. (See section 10.6.)

**Wave Parameter**

Saves the maximum number of data items (either 100,000/(the number of items set to ON)) back from the point at which the save was executed.

- **Data Size**

Data size (bytes) = the number of measurement parameters × 15 × the number of history waveforms

- **Output example**

Analysis Type	WaveParameter									
Model Name	DL9000									
Model Version	**									
	Rms(C1)	Mean(C1)	Sdev(C1)	ITY(C1)	CRms(C1)	CMean(C1)	CSdev(C1)	Dly(C1)	Calc1(A2)	
	V	V	V	Vs	V	V	V	s		
:Max	7.12E-01	5.05E-03	7.12E-01	5.05E-05	7.12E-01	5.33E-03	7.12E-01	1.13E-03	1.13E+00	
:Min	7.10E-01	-4.44E-03	7.10E-01	-4.44E-05	7.10E-01	-4.46E-03	7.10E-01	-8.99E-04	1.08E+00	
:Mean	7.11E-01	1.07E-03	7.11E-01	1.07E-05	7.11E-01	1.05E-03	7.11E-01	3.44E-04	1.10E+00	
:Sigma	2.47E-04	2.04E-03	2.48E-04	2.04E-05	3.42E-04	2.11E-03	3.42E-04	9.68E-04	8.23E-03	
:Cnt	134	134	134	134	134	134	134	134	134	
7021	7.11E-01	2.29E-03	7.11E-01	2.29E-05	7.12E-01	2.33E-03	7.12E-01	1.11E-03	1.10E+00	
7031	7.11E-01	1.43E-03	7.11E-01	1.43E-05	7.11E-01	1.41E-03	7.11E-01	1.11E-03	1.11E+00	
7040	7.11E-01	3.51E-03	7.11E-01	3.51E-05	7.11E-01	3.01E-03	7.11E-01	1.11E-03	1.10E+00	
7050	7.11E-01	1.73E-03	7.11E-01	1.73E-05	7.12E-01	1.86E-03	7.12E-01	1.11E-03	1.11E+00	
7059	7.11E-01	1.80E-03	7.11E-01	1.80E-05	7.11E-01	1.99E-03	7.11E-01	-8.86E-04	1.11E+00	
7069	7.11E-01	1.15E-03	7.11E-01	1.15E-05	7.11E-01	1.13E-03	7.11E-01	1.11E-03	1.10E+00	
7078	7.11E-01	1.45E-04	7.11E-01	1.45E-06	7.11E-01	-1.77E-04	7.11E-01	-8.82E-04	1.12E+00	
7088	7.11E-01	2.98E-03	7.11E-01	2.98E-05	7.11E-01	3.18E-03	7.11E-01	1.11E-03	1.10E+00	
7098	7.11E-01	3.27E-03	7.11E-01	3.27E-05	7.10E-01	3.69E-03	7.10E-01	-8.92E-04	1.09E+00	
7107	7.11E-01	3.12E-03	7.11E-01	3.12E-05	7.11E-01	2.92E-03	7.11E-01	-8.83E-04	1.12E+00	

## 13.9 Saving Analysis Results

---

### Accum Histogram

A maximum of 640 data items are saved in Horizontal mode, and a maximum of 800 data items are saved in Vertical mode.

- **Data Size**

Data size (bytes) = Number of analyses × 15

- **Output example**

---

Analysis Type	AccumHistogram
Model Name	DL9000
Model Version	9.99
8	
150	
9	
154	
6	
154	
8	
156	
9	
153	

---

### FFT

Saves data for a maximum of 250 K points.

- **Data Size**

Data size (bytes) = Number of data points × 15

- **Output example**

---

Analysis Type	FFT
Model Name	DL9000
Model Version	* **
	-3.10E+01
	-5.43E+01
	-4.16E+01
	-6.69E+01
	-4.80E+01
	-5.26E+01
	-6.39E+01
	-5.11E+01
	-5.17E+01
	-5.87E+01

---

### Target of Save: Source

Select either Ana1 or Ana2.

### Setting the File Name:File Name

Same as the explanation given in “Setting the File Name” in section 13.4.

### Setting a Comment:Comment

Same as the explanation given in “Setting a Comment” in section 13.4.

## 13.10 Changing the File Attributes and Deleting Files

### CAUTION

Do not remove the storage medium (disk) or turn OFF the power when the access indicator is blinking. Doing so can damage the storage medium or destroy the data on the medium.

### Procedure

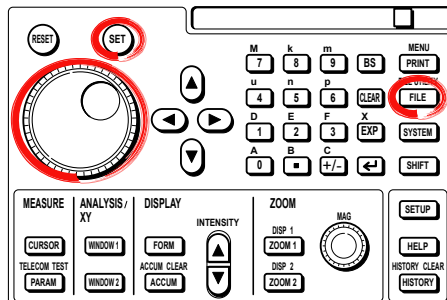

1. Press **FILE**. The File List window appears.

### Selecting the File

2. Select the storage medium or directory as described in steps 2 and 3 of section 13.5, "Saving/Loading the Measurement Data."
3. Using the **rotary knob**, select the file. To select all files, press the Select All soft key. To remove the selection, press **RESET**.

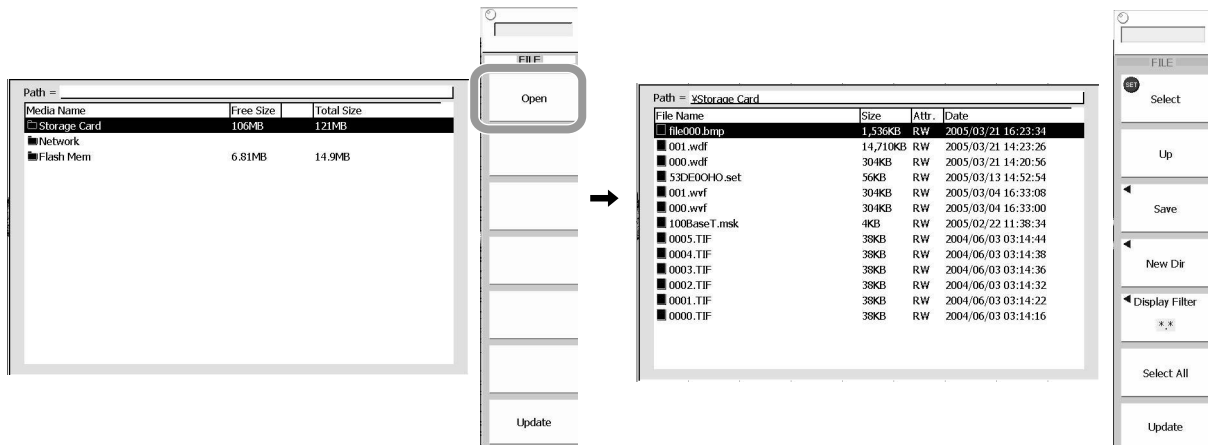

**Changing the File Attributes**

- 4. Press **Select** soft key or **SET**. A menu of file operations appears.
- 5. Press the **Protect** soft key.

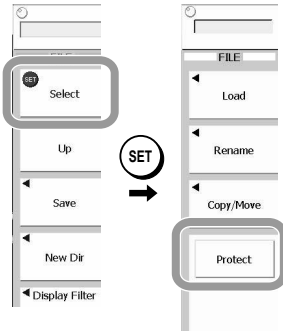

Changes the Attr parameter of the list to RW (readable/writeable) or RA (not writeable).

The Protect soft key changes to the Abort soft key.

**Aborting Attribute Changes**

- 6. Press the **Abort** soft key. The attribute changes are aborted. At the same time, the Abort soft key changes to the Protect soft key.

**Deleting Files**

- 7. Press the **Delete** soft key. A confirmation message appears.
- 8. Use the **rotary knob** to select either OK or Cancel and then press **SET**. If OK was selected, the file is deleted.

The Delete soft key changes to the Abort soft key.

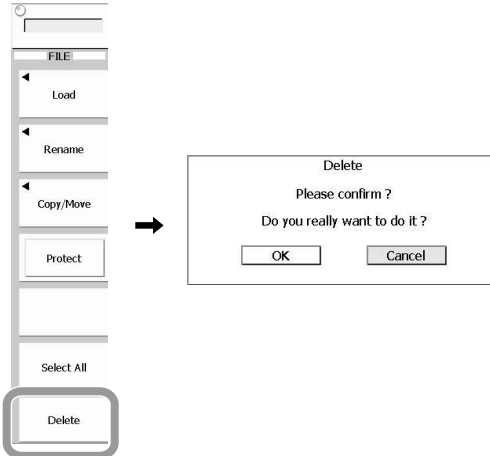

**Aborting File Deletion**

- 9. Press the **Abort** soft key. File deletion is aborted. At the same time, the Abort soft key changes to the Delete soft key.

**Specifying the Files to Be Displayed in the File List Dialog Box**

You can specify the format of files to be displayed in the file list. Set it as necessary.

- 10. Set the extension for the file displayed in the File List dialog box according to the procedure described on pages 13-6.

**Explanation****Selecting the Storage Medium and Directory: File**

Storage media in which saving and loading are possible are displayed in the File List dialog box.

**Display Examples of Storage Media**

Same as the explanation given in “Display Examples of Storage Media” of section 13.4.

**Changing the File Attribute: Attr (Except for Net Drive)**

Select the file attribute of each file from the following.

- **RW**  
Read and write possible.
- **RA**  
Read only. Cannot be written. Cannot be erased.

**Selecting the Files to Be Deleted**

All highlighted files can be deleted. There are two methods in selecting the files to be deleted.

- **Selecting the files one at a time: Set**  
Press the Set soft key to select files one at a time.
- **Selecting all files at once: Select All**  
Press the Select All soft key to select all files.  
Selecting a file or directory and pressing the Select All soft key selects every file and directory in the directory containing the selected file or directory.

**Specifying the Files to Be Displayed in the File List Dialog Box: Display Filter**

Specify the type of files to be displayed.

Same as the explanation given in “Specifying the Files to Be Displayed in the File List Dialog Box” in section 13.4.

**Note**

- 
- Data that is deleted cannot be recovered. Be sure you erase the correct files.
  - If an error occurs while deleting multiple files, the files after the error occurrence are not deleted.
  - You cannot change a directory attribute.
-

## 13.11 Copying/Moving Files

### CAUTION

Do not remove the storage medium (disk) or turn OFF the power when the access indicator is blinking. Doing so can damage the storage medium or destroy the data on the medium.

### Procedure

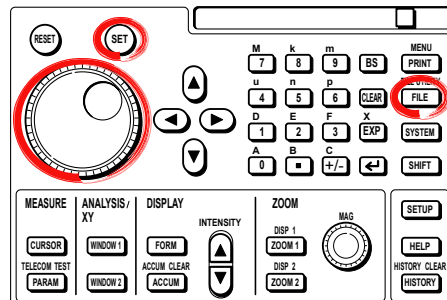

1. Press **FILE**. The File List window appears.

### Selecting the File

2. Select the storage medium or directory as described in steps 2 and 3 of section 13.5, "Saving/Loading the Measurement Data."
3. Using the **rotary knob**, select the file. To select all files, press the Select All soft key.

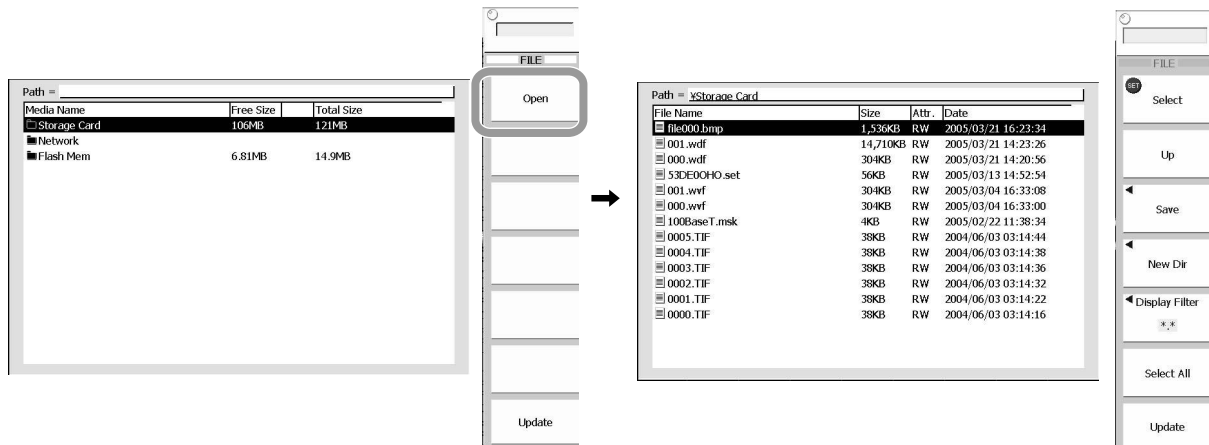



4. Press the **Select** soft key or **SET**. A menu of file operations appears.

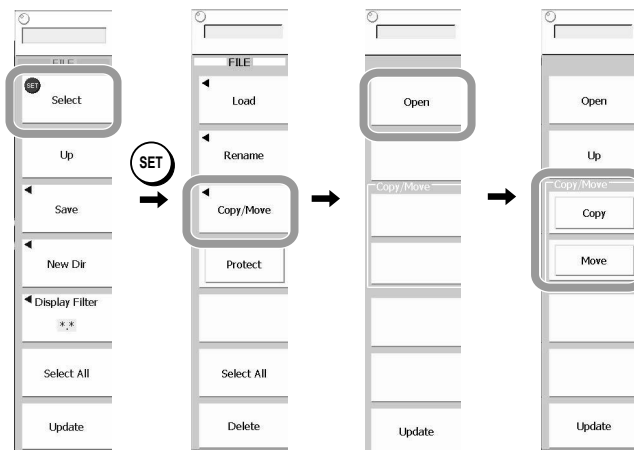

### Setting the File Copy/Move Destination

5. Press the **Copy/Move** soft key.
6. Select the storage medium/directory in the same manner as described in step 2. To update the file list with the most recent data, press the **Update** soft key.

### Copying/Moving Files

7. Press the **Copy** or **Move** soft key. The file that was selected in step 3 is moved or copied. The Copy or Move soft key changes to the Abort soft key.

### Aborting File Copying/Moving

8. Press the **Abort** soft key. File copying or moving is aborted. At the same time, the Abort soft key changes to the Copy or Move soft key.

### Specifying the Files to Be Displayed in the File List Dialog Box

- You can specify the format of files to be displayed in the file list. Set it as necessary.
9. Set the extension for the file displayed in the File List dialog box according to the procedure described on pages 13-6.

### Explanation

#### Selecting the Files To Be Moved/Copied

Highlighted files can be copied or moved. There are two ways to select the files to be copied or moved.

- **Selecting the files one at a time: Set**  
Press the Set soft key to select files one at a time.
- **Selecting all files at once: Select All**  
Press the Select All soft key to select all files.  
Selecting a file or directory and pressing the Select All soft key selects every file and directory in the directory containing the selected file or directory.

#### Specifying the Files to Be Displayed in the File List Dialog Box: Display Filter

Specify the type of files to be displayed.

Same as the explanation given in “Specifying the Files to Be Displayed in the File List Dialog Box” in section 13.4.

#### *Note*

---

- If an error occurs while copying/moving multiple files, the files after the error occurrence are not copied/moved.
  - You cannot copy/move files if files with the same file name exist at the copy/move destination.
  - You cannot copy/move the same files to another directory after copying/moving the files. Select the files to be copied again and then copy them.
  - A total of 2500 directories and files can be displayed in the file list. If there are more than 2500 directories and files in a single directory, a total of 2500 files and directories will be displayed, but it is not possible to specify which directories and files are displayed.
-

# 13.12 Changing the Directory Name or File Name of the Storage Medium/Creating Directories

## CAUTION

Do not remove the storage medium (disk) or turn OFF the power when the access indicator is blinking. Doing so can damage the storage medium or destroy the data on the medium.

## Procedure

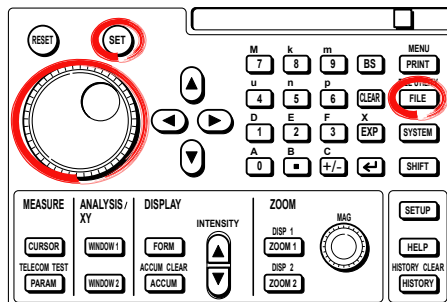

### Renaming a Storage Medium Directory or File

1. Press **FILE**. The File List window appears.

### Selecting the Storage Medium/Directory

2. Select the storage medium, directory, or target file as described in steps 2 and 3 of section 13.5, "Saving/Loading the Measurement Data."

### Renaming the Storage Medium Directory/File (Except Net Drive)

3. Using the **rotary knob**, select the directory name/file name.
4. Press the **Select** soft key or **SET**. A menu of file operations appears.
5. Press the **Rename** soft key. The keyboard is displayed, and the name of the selected directory or file is displayed in the entry box of the keyboard.
6. Enter the directory name/file name as described in section 4.2.

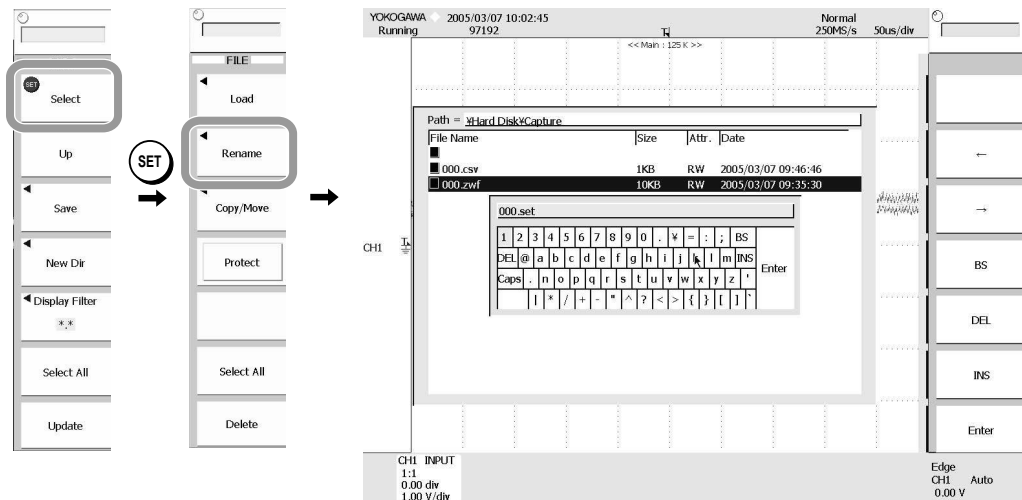

## 13.12 Changing the Directory Name or File Name of the Storage Medium/Creating Directories

### Specifying the Files to Be Displayed in the File List Dialog Box

You can specify the format of files to be displayed in the file list. Set it as necessary.

7. Set the extension for the file displayed in the File List dialog box according to the procedure described on pages 13-6.

### Creating a Directory

1. Press **FILE**. The File List window appears.

### Selecting the Storage Medium/Directory

2. Select the storage medium or directory as described in steps 2 and 3 of section 13.5, "Saving/Loading the Measurement Data."

### Creating a Directory

3. Press the **Open** soft key. A directory is created in the storage medium/directory that is currently open.
4. Press the **New Dir** soft key. A keyboard appears.
5. Enter the directory name/file name as described in section 4.2.

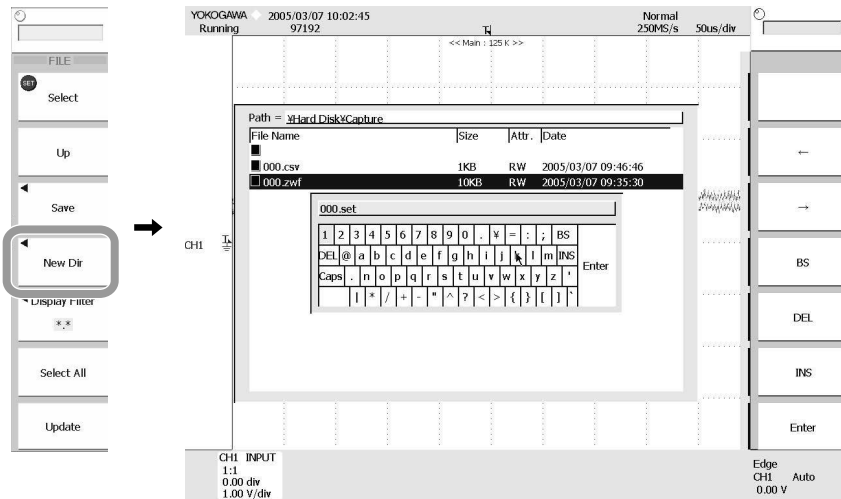

### Specifying the Files to Be Displayed in the File List Dialog Box

You can specify the format of files to be displayed in the file list. Set it as necessary.

6. Set the extension for the file displayed in the File List dialog box according to the procedure described on pages 13-6.

**Explanation****Selecting the Storage Medium and Directory: File**

Storage media in which saving and loading are possible are displayed in the File List dialog box.

**Display Examples of Storage Media**

Same as the explanation given in “Display Examples of Storage Media” of section 13.4.

**Renaming a Storage Medium Directory or File: RENAME**

The number of characters that can be used for a file or directory name is up to 64 characters from the beginning of the entered characters. However, the following conditions apply.

- The types of characters that can be used are 0 to 9, A to Z, a to z, \_, -, =, (, ), {, }, [, ], #, \$, %, &, ~, !, ', and @ on the keyboard that appears on screen.
- The following character strings cannot be used due to the limitation of MS-DOS. AUX, CON, PRN, NUL, CLOCK, LPT1, LPT2, LPT3, LPT4, LPT5, LPT6, LPT7, LPT8, LPT9, COM1, COM2, COM3, COM4, COM5, COM6, COM7, COM8, and COM9
- Make sure that the full path name (absolute path name from the root directory) is within 260 characters. If 260 characters is exceeded, an error occurs when you execute a file operation (save, copy, rename, create directory, etc.).  
Full path name:           If you are operating a directory, specify up to the directory name.  
                                  If you are operating a file, specify up to the file name.
- The length of the character string displayed in the entry box of the keyboard that is shown on the screen is 36.

**Creating a Directory: New Dir**

You can create a new directory on the storage medium. See above for the assignment of the directory name when creating a new directory.

**Specifying the Files to Be Displayed in the File List Dialog Box: Display Filter**

Specify the type of files to be displayed.

Same as the explanation given in “Specifying the Files to Be Displayed in the File List Dialog Box” in section 13.4.

**Note**

- 
- You cannot change a directory attribute.
  - If a file with the same name already exists in the same directory, the file cannot be renamed.
  - If a directory with the same name already exists in the same directory, the directory cannot be created.
  - This unit can recognize a maximum of 26 media.
-

## 13.13 Connecting to a PC Using the USB Port

### Procedure

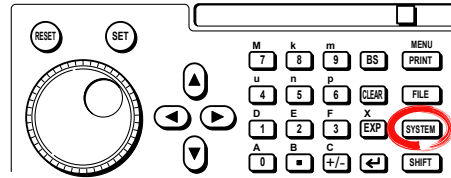

1. Press the **SYSTEM** soft key to display the SYSTEM menu.
2. Press the **Next 1/2** soft key.
3. Press the **USB Function** soft key to display the USB Function menu.
4. Press the **TMC & Mass Storage**, **TMC**, or **Mass Storage** soft key to select the communication function.
5. Restart the DL9000 to activate the settings.  
Wait at least 10 seconds after you turn the power switch OFF, and then turn the switch back ON.

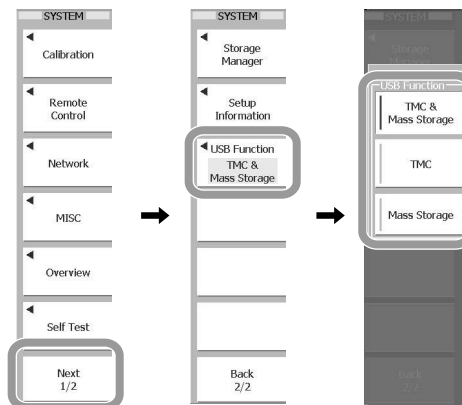

### Explanation

You can connect the DL9000 to a PC through the USB port, and control the DL9000 from the PC.

#### Selecting the USB Communication Function

- TMC
  - Allows communication with the PC using the USB TMC (Test and Measurement Class).
  - You must install YOKOGAWA's USB TMC driver in the PC to use the USB TMC function.
  - Only use the USB TMC driver (or software) provided by YOKOGAWA.
- Mass Storage
  - The DL9000 functions as a USB mass storage device as viewed from the PC.
  - There is no need to install the USB TMC driver into your PC.
- TMC & Mass Storage
  - Allows communication with the PC using both USB TMC and USB Mass Storage.
  - You must install Yokogawa's USB TMC driver into your PC to use the USB TMC function in the same manner as when TMC is selected above.
  - Only use the USB TMC driver (or software) provided by YOKOGAWA.

#### **Note**

- To obtain YOKOGAWA's USB TMC driver, contact your nearest YOKOGAWA dealer or access the following USB driver page at our Web site and download it.  
<http://www.yokogawa.com/tm/tm-softdownload.htm>
  - You must restart the DL9000 to activate the TMC, Mass Storage, or TMC & Mass Storage setting. Wait at least 10 seconds after you turn the power switch OFF, and then turn the switch back ON.
  - To use the USB port as a remote control port (control using communication commands), activate the TMC or TMC & Mass Storage setting. For the procedure to select the remote control port, see the *Communication Interface User's Manual IM701310-17E*.
  - File operation using the DL9000 keys is not possible, if the Mass Storage or TMC & Mass Storage is activated and the DL9000 is connected to a PC. File operation is also not possible using communication commands. Disconnect the PC or activate the TMC setting and connect the DL9000 to the PC.
-

# 14.1 Turning ON/OFF the Reference Waveform Display

## Procedure

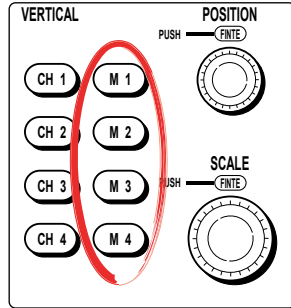

1. Press the key from **M1** to **M4** to select the waveform to be set. The key lights, and the waveform appears.
2. Press the **Select** soft key to set to REF.

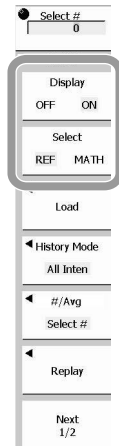

### Switching the Display OFF

1. Press the key to be turned off, from **M1** to **M4**.
2. Press the **Display** soft key, and select OFF.

## Explanation

A history waveform of input channels, a computed waveform and a waveform saved in the internal memory can be displayed as reference waveforms of 1 to 4. The DL9000 also allows you to perform computation with data of displayed reference waveform. When the reference waveform is set to ON, a computed waveform corresponding to the reference number cannot be displayed.

The reference waveform is backed up to internal memory even when the power to the DL9000 main unit is turned OFF. The waveform is displayed again the next time the power is turned ON.

To delete all backup data, turn ON the power while holding down the **Reset** key.

### Note

- With history waveforms, only the most recent waveforms are backed up.
- Waveforms whose record lengths exceed 125 kW are not backed up.



## 14.2 Displaying Stored Data as Reference Waveform

### Procedure

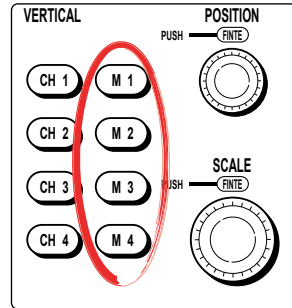

1. Press the key from **M1** to **M4** to select the waveform to be set.
2. Press the **Load** soft key. The menu appears, allowing you to select a waveform to be loaded.
3. Press the soft key corresponding to the waveform to be loaded.

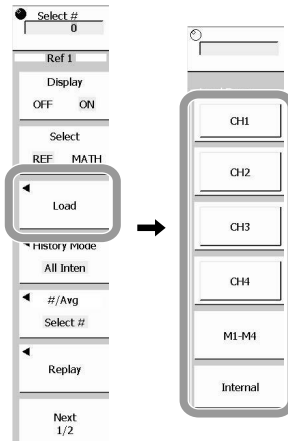

### Selecting History Mode

4. Press the **History Mode** soft key. A menu appears, allowing you to select the history mode.
5. Press one of the following soft keys.
  - ONE: Displays only highlight waveforms selected in the following procedure
  - All Half Tone: Displays waveforms other than highlight waveforms in neutral color
  - All Inten: Displays the frequency of data appearance at intensity
  - All Color: Displays the frequency of data appearance in color

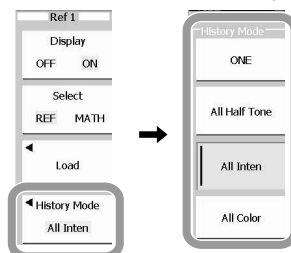

**Selecting Highlight Waveform**

6. When you select ONE or All Halftone in Step 5, select highlight waveforms. Select the **#/Avg** soft key to select either the history number (#) or the average value (Avg).
7. When you select a highlight waveform with history numbers (#), select the number with the rotary knob.

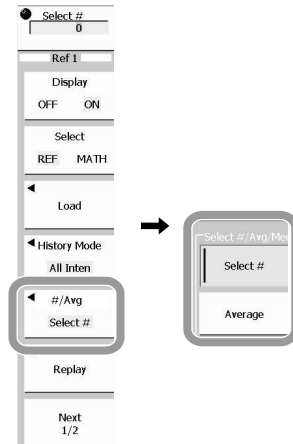

## 14.3 Displaying Waveforms Inverted

### Procedure

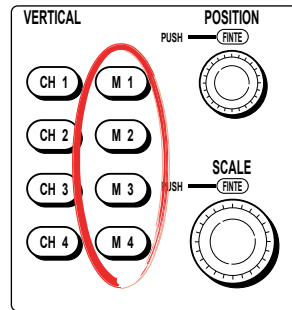

1. Press the key from **M1** to **M4** to display reference waveforms.
2. Press the **Next 1/2** soft key.
3. Press the **Invert** soft key.

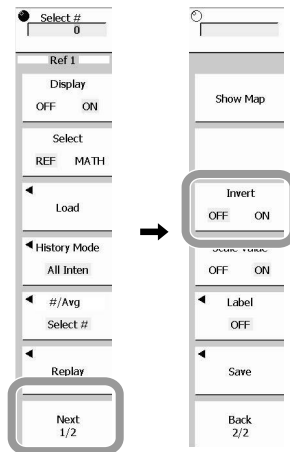

## 14.4 Saving Data

### Procedure

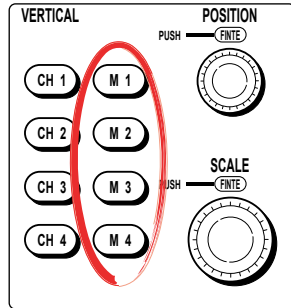

1. Press the key from **M1** to **M4** to display reference waveforms.
2. Press the **Next 1/2** soft key.
3. Press the **Save** soft key. A menu appears, allowing you to select the save destination.
4. Press one of the soft keys of the internal memory **#1** to **#4**.  
The reference waveform is stored in the selected internal memory.

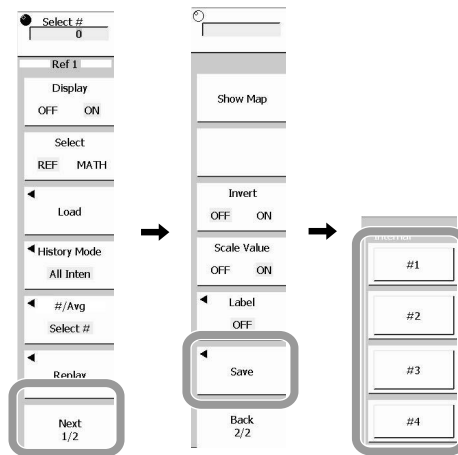

### Note

A waveform exceeding 1.25 MW is saved with P-P compression to 1.25 MW.

## 14.5 Displaying Scale Values and Labels

### Procedure

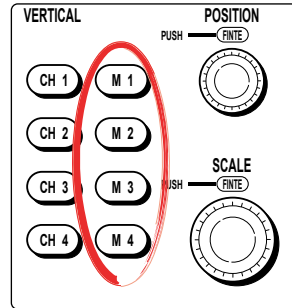

1. Press the key from **M1** to **M4** to display reference waveforms.
2. Press the **Next 1/2** soft key.

### Displaying the Scale Value

3. Press the **Scale Value** soft key to select ON or OFF.

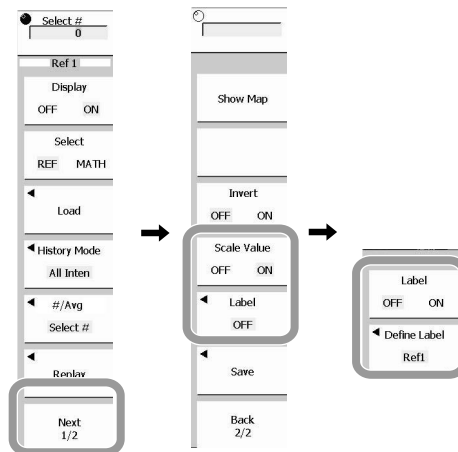

### Displaying the Label

4. Press the **Label** soft key. The label setup menu appears.
5. Press the **Label** soft key to select ON or OFF.
6. Press the **Define Label** soft key. A keyboard appears.
7. Enter the contents of label as described in section 4.2.

## 14.6 Displaying History Waveforms Automatically

### Procedure

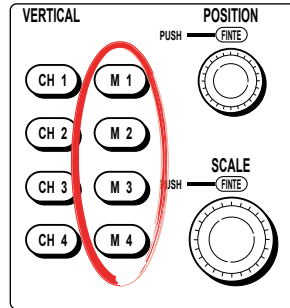

1. Press the key from **M1** to **M4** to select the waveform to be set.
2. Press the **Replay** soft key. A menu appears, allowing you to display history waveforms automatically.
3. Press the **<Play** or **Play>** soft key to display history waveforms automatically.

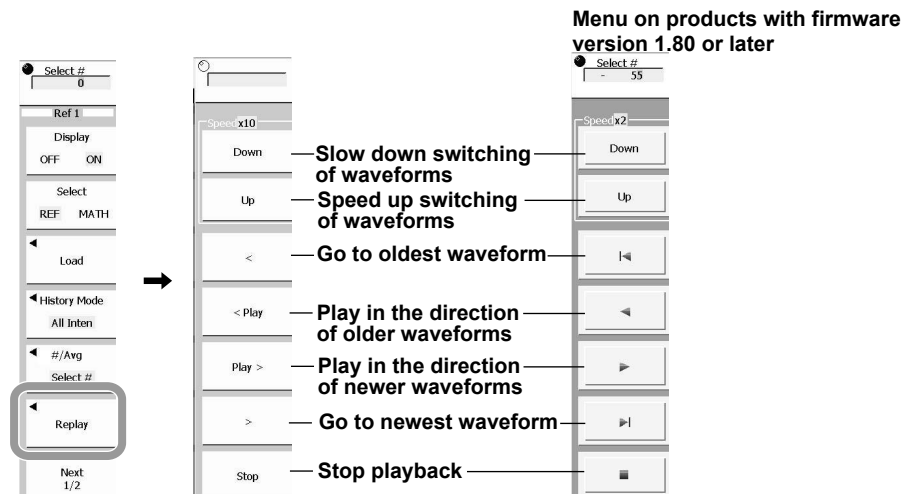

### Explanation

History waveforms are displayed individually in sequence.

## 14.7 Displaying the Acquisition Time of a Loaded Waveform

### Procedure

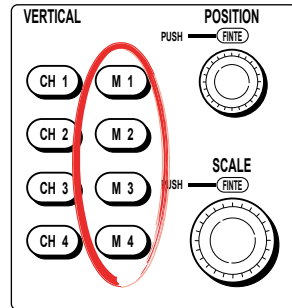

1. Press one of **M1** to **M4** to display the reference waveform.
2. Press the **Next 1/2** soft key.
3. Press the **Show Map** soft key.

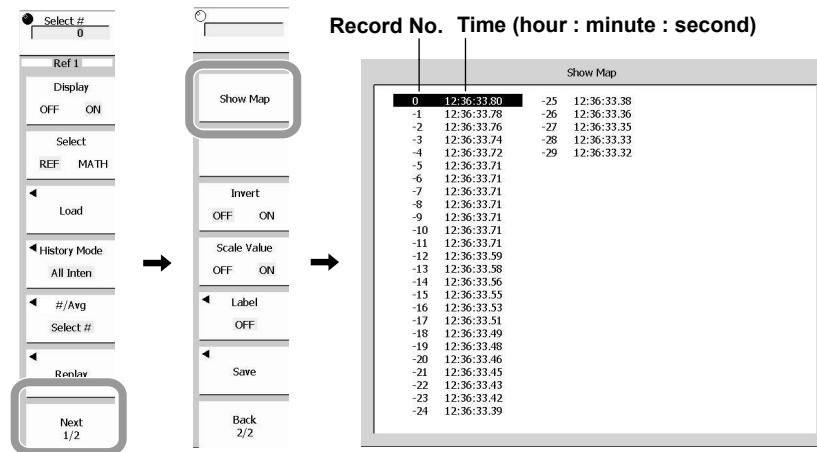

## 15.1 Connecting the DL9000 to the Network

### Ethernet Interface Specifications

A 100BASE-TX port is provided on the rear panel of the DL9000.

Item	Specifications
Number of communication ports	1
Electrical and mechanical specifications	Conforms to IEEE802.3
Transmission system	Ethernet (100BASE-TX/10BASE-T)
Transmission rate	100 Mbps max.
Communication protocol	TCP/IP
Supported service	DHCP, DNS, MicroSoft network file shared client/server
Connector type	RJ-45 connector

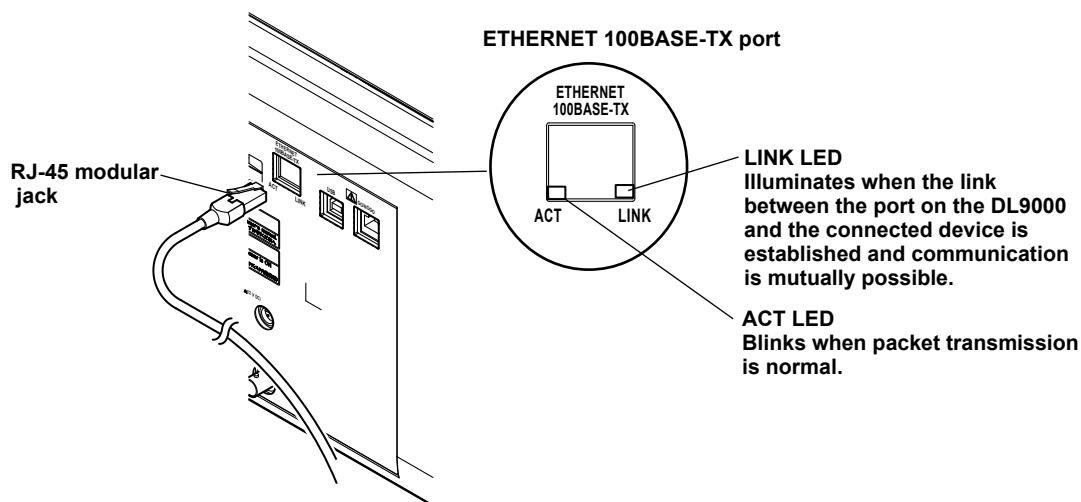

### Items Necessary for Connection

#### Cable

Be sure to use one of the following cables for connection.

- UTP (Unshielded Twisted-Pair) cable (category 5 or better)
- STP (Shielded Twisted-Pair) cable (category 5 or better)



### Connection Procedure

#### When Connecting to a PC on the Network

1. Turn OFF the DL9000.
2. Connect one end of the UTP (or STP) cable to the ETHERNET 100BASE-TX terminal on the rear panel.
3. Connect the other end of the UTP (or STP) cable to a hub or router.
4. Turn ON the DL9000.

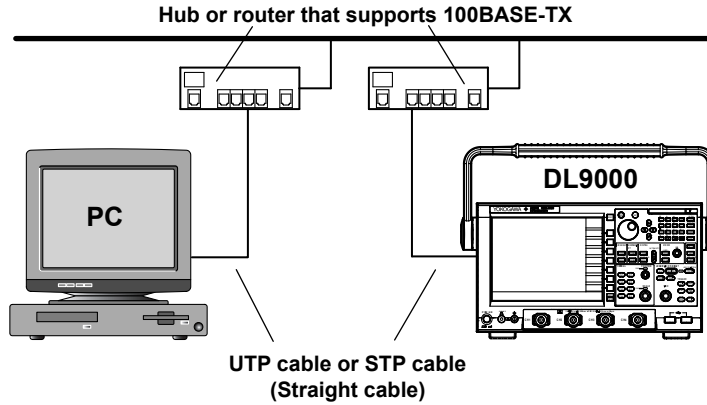

#### When Establishing a One-to-One Connection to a PC

1. Turn OFF the DL9000 and the PC.
2. Connect one end of the UTP (or STP) cable to the ETHERNET 100BASE-TX terminal on the rear panel.
3. Connect the other end of the UTP (or STP) cable to a hub or router.
4. Likewise, connect the PC to a hub or router.
5. Turn ON the DL9000.

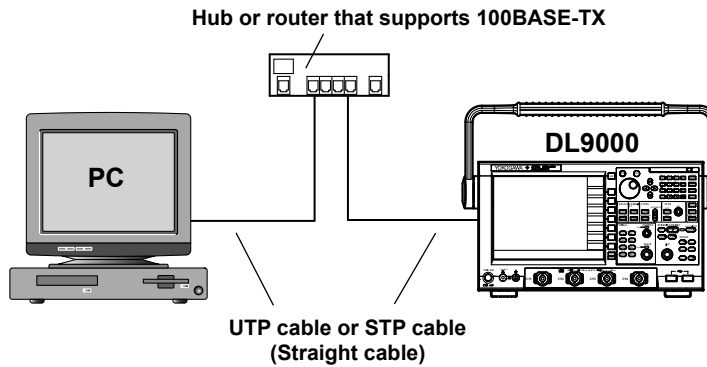

#### Note

- When connecting the PC one-to-one, a NIC (a 10BASE-T/100BASE-TX autoswitching card) is required for the PC.
  - When using a UTP cable or STP cable (both are straight cables), be sure to use a category 5 or better cable.
  - Avoid connecting the PC directly to the DL9000 without going through the hub or router. Operations are not guaranteed for communications using direct connection.
-

## 15.2 Setting Up the TCP/IP

### Procedure

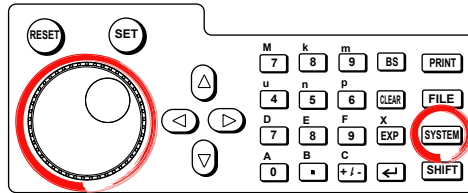

1. Press **SYSTEM**.
2. Press the **Network** soft key.
3. Press the **TCP/IP Setup** soft key. The TCP/IP setup menu appears.

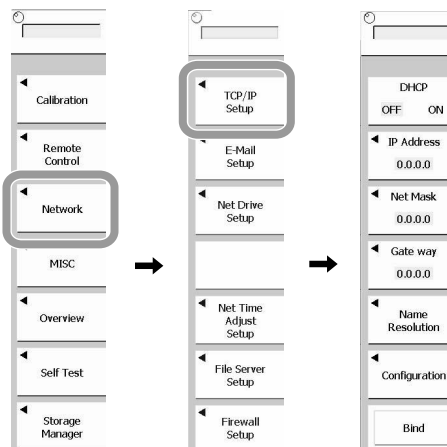

### DHCP ON/OFF

4. Press the **DHCP** soft key to select either ON or OFF.  
If you set the DHCP to OFF, proceed to step 5.  
If you set the DHCP to ON, you do not have to set the IP address, subnet mask and default gateway.
  - To set the DNS, proceed to step 11.
  - If you do not wish to set up the DNS, check the network cable connection and restart the DL9000. The IP address, subnet mask, and default gateway are automatically configured.

## 15.2 Setting Up the TCP/IP

### Setting up IP Address

If DHCP was set to OFF, set the IP address.

5. Press the **IP Address** soft key. A screen appears, allowing you to set up the IP address.
6. Enter a value in the range of 0 to 255 as described in section 4.2.

### Setting up Subnet Mask

If DHCP was set to OFF, set the subnet mask.

7. Press the **Net Mask** soft key. A screen appears, allowing you to set up the subnet mask.
8. Enter a value in the range of 0 to 255 as described in section 4.2.

### Setting up Default Gateway

If DHCP was set to OFF, set the default gateway.

9. Press the **Gate way** soft key. A screen appears, allowing you to set up the default gateway.
10. Enter a value in the range of 0 to 255 as described in section 4.2.

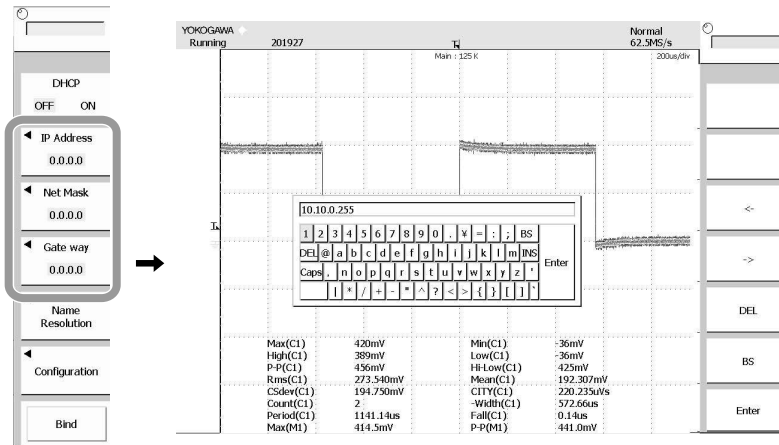

### Setting up DNS and WINS

11. Press the **Name Resolution** soft key. The DNS/WINS setup menu appears.
12. Press the **Host Name** soft key. A screen appears, allowing you to set up the host name of the DL 9000.
13. Set up the host name of the instrument as described in section 4.2.

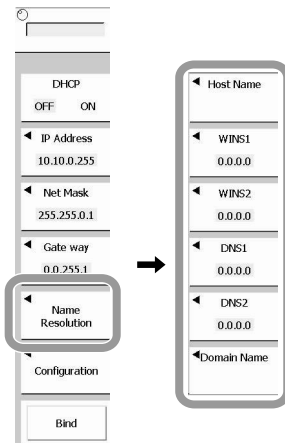

- **When Using WINS**

14. Press the **WINS1** soft key. A screen appears, allowing you to set up the WINS address.
15. Set up the primary address of WINS as described in section 4.2.
16. Likewise, set up the secondary address of WINS.

- **When Using DNS**

17. Press the **DNS1** soft key. A screen appears, allowing you to set up the DNS address.
18. Set up the primary address of DNS as described in section 4.2.
19. Likewise, set up the secondary address of DNS.
20. Press the **Domain Name** soft key. A screen appears, allowing you to set up the domain name.
21. Set up the domain name as described in section 4.2.

**Note**

For the operating procedure of the keyboard (software keyboard), see section 4.2.

**Checking Setup Items**

22. Press the **Configuration** soft key. Setup data appears.  
To clear the setup data, press **ESC**.  
MAC address is a value that appears on the right side of Physical Address.

```

--- Network Information ---
- DHCP           : OFF
- Host Name      : DL9000
- IP Address     : 192.168.0.10
- Net Mask      : 255.255.255.0
- Gateway       : 192.168.0.1
- WINS1         : 192.168.0.2
- WINS2         : 192.168.0.3
- DNS1          : 192.168.0.4
- DNS2          : 192.168.0.5
- Domain        : yokogawa.co.jp
- Physical Address : 

```

**Excuting the Bind**

23. Press the **Bind** soft key to enable setup data.

### Explanation

The following TCP/IP settings must be entered to use the Ethernet communications functions on the DL9000.

- IP address
- Subnet mask
- Default gateway

#### **IP Address (Internet Protocol Address)**

You can assign an IP address to the DL9000. The default setting is 0.0.0.0.

The IP address is an ID that is assigned to each device on an IP network such as the internet or an intranet. The address is a 32-bit value expressed using four octets (each 0 to 255), each separated by a period as in 192.168.111.24.

Obtain an IP address from your network administrator. The setting is automatically configured in environments using DHCP.

#### **Subnet mask: Net Mask**

You can set the mask value used when determining the subnet network address from the IP address. The default setting is 0.0.0.0.

Huge TCP/IP networks such as the Internet are often divided up into smaller networks called sub networks. The subnet mask is a 32 bit value that specifies the number of bits of the IP address used to identify the network address. The portion other than the network address is the host address that identifies individual computers on the network. Consult your network administrator for the subnet mask value. The setting is automatically configured in environments using DHCP.

#### **Default gateway: Gate Way**

You can set the IP address of the gateway (default gateway) used to communicate with other networks. The default setting is 0.0.0.0.

The default gateway has a function to enable the smooth transfer of data when communicating with multiple networks.

Consult your network administrator for the default gateway value. The setting is automatically configured in environments using DHCP.

#### **DHCP (Dynamic Host Configuration Protocol): DHCP**

DCHP is a protocol that allocates setup information that is needed temporarily to PCs connecting to the network. When DHCP is turned ON, the following settings are automatically assigned.

- IP address
- Subnet mask
- Default gateway
- DNS
- WINS
- Domain name

To use DHCP, the network must have a DHCP server. Consult your network administrator to see if DHCP can be used.

If DHCP is set to ON, when the power is turned on for example, each time a Bind operation is executed different values may be assigned. To connect a PC to the DL9000, you need to check the configuration such as the IP address of the instrument on the PC every time the device is turned on or every time a Bind operation.

**DNS (Domain Name System)**

DNS is a system used to associate names used on the Internet called host names and domain names with IP addresses. Given AAA.BBBBB.com, AAA is the host name and BBBBB.com is the domain name.

Instead of using the IP address, which is a sequence of numbers, the host name and domain name can be used to access the network.

The DL9000 allows you to specify the host by name, instead of by IP address.

You set the domain name, and the DNS server address (0.0.0.0 by default). For details, consult your network administrator.

- **DNS Server: DNS1/DNS2**

Up to two DNS server addresses can be specified (primary and secondary). If query processing fails with the primary DNS server, the secondary DNS server is automatically looked up for the mapping of the host name/domain name and IP address.

- **Domain name: DomainName**

Domain name is a piece of information to be added to a host name on query to the DNS server.

**WINS(Windows Internet Name Service)**

WINS is a service that associates a NetBIOS name with an IP address of computer on the Windows network. WINS allows you to connect the DL9000 to the network in the various segments.

**Note**

- Execute the Bind operation when you change the configuration on Ethernet.
- **Configuring the TCP/IP Settings of the PC**  
Communication parameters such as the IP address must be specified also on the PC side. Communication parameters are specified for each Ethernet NIC that is installed in the PC. Here, the settings of the NIC for connecting your PC and the DL9000 are explained. When using the DHCP server, and automatically allocating an IP address, in [TCP/IP Properties]-[IP Address Setting], select [Automatically Assign IP Address]. For example, if you are connecting a PC and the DL9000 to an Ethernet network on a one-to-one basis, you can specify parameters as indicated in the next table. For details on the parameters, consult your system or network administrator.

Parameter	Value	Remarks
IP address	(Ex) 192.168.0.128	IP address for the PC
Subnet mask	(Ex) 255.255.255.0	Set the same value as the subnet mask that was specified for the DL9000.
Gateway	0.0.0.0 (Default)	
DNS	Disable	
WINS	Disable	

The following procedure describes the steps for Windows 2000. For other OS including Windows XP, carry out equivalent steps accordingly.

1. Choose Settings > Control Panel from the Start menu to open the Control Panel folder.
2. Double-click the Network and Dial-up icon.
3. Right-click the Local Area Connection to select the Properties.
4. After selecting Internet Protocol (TCP/IP), click the Properties button to display the TCP/IP Properties dialog box.

## 15.2 Setting Up the TCP/IP

---

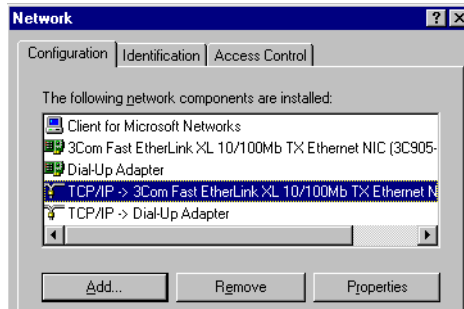

5. Set the parameters such as the IP address according to the table on the previous page and click OK.

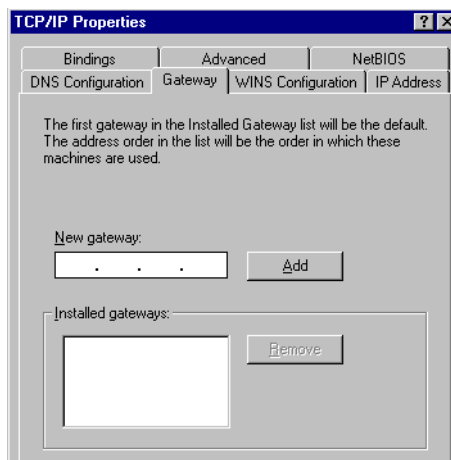
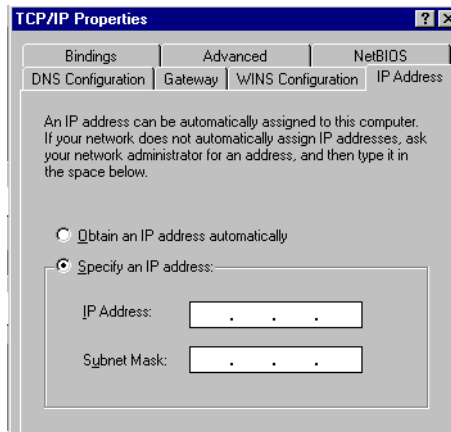

---

### MAC Address

MAC address is a unique (single) address that is pre-assigned to each Ethernet device. The address is necessary to physically identify the Ethernet devices on the network. Data can be transferred between nodes based on the MAC address.

## 15.3 Saving and Loading Waveform/Setup/Image Data on a Network Drive

### Procedure

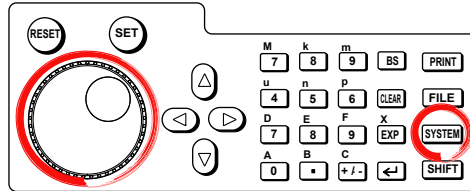

1. Press **SYSTEM**.
2. Press the **Network** soft key.
3. Press the **Net Drive Setup** soft key. The Net Drive setup menu for that key appears.

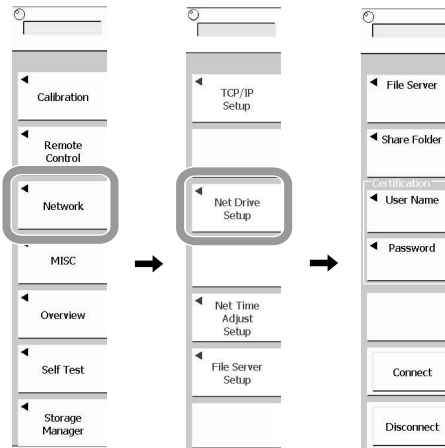

### Setting a Network Drive to Be Connected

4. Press the **File Server** soft key. A screen appears, allowing you to set up server name for the file server. The IP address cannot be used to set up the file server.
5. Enter the server name for the file server as described in section 4.2.

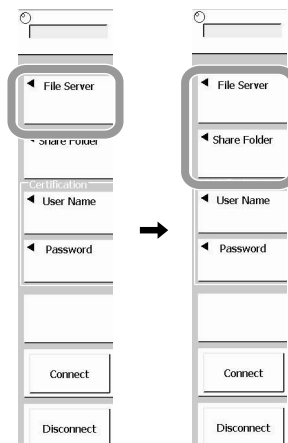

6. Press the **Share Folder** soft key. A screen appears, allowing you to set up the shared folder name.
7. Set up the folder name as described in section 4.2.



### 15.3 Saving and Loading Waveform/Setup/Image Data on a Network Drive

---

#### Setting User Name/Password

8. Press the **User Name** soft key. A screen appears, allowing you to set up a user name.
9. Enter a user name using up to 30 characters as described in section 4.2.
10. Press the **Password** soft key. A screen appears, allowing you to set up a password.
11. Enter a password using up to 30 characters for the user name as described in section 4.2.

#### Note

---

For the operating procedure of the keyboard (software keyboard), see section 4.2.

---

#### Connecting to/Disconnecting from the Network Drive

12. Press the **Connect** soft key. The DL9000 is now connected to the network drive.

When pressing the **Disconnect** soft key, the DL9000 is disconnected.



#### Saving Screen Images and Saving/Loading Waveform/Setup Data

- **Saving the Screen Image Data**

13. Press the **SHIFT + PRINT** key.
14. The procedure is similar to that in section 13.8, "Saving Screen Image Data." Select the network drive in the File Path setup

- **Saving/Loading Waveform Data/Setup Data**

13. Press **FILE**.
14. Select a network drive with the **rotary knob**.  
The procedure afterward is similar to those in section 13.4, "Saving/Loading the Setup Data" and section 13.5, "Saving/Loading the Measurement Data."

#### Explanation

As with the PC card drive, you can save screen image data, waveform data or setup data to a network drive via the Ethernet network.

#### File Server

Enter the host name of file server (the PC running the file server) on the network to which waveform/setup data will be saved. The IP address cannot be used to set up the file server.

#### User Name

Enter a user name using up to 30 characters.  
The characters that can be used are all the ASCII characters on the keyboard.

#### Password

Enter the password corresponding to the user name using up to 30 characters.  
The characters that can be used are all the ASCII characters on the keyboard.

#### *Note*

- 
- A shared service should be run on a personal computer to which the DL 9000 is connected.
  - To use this function, you must configure TCP/IP according to the procedure given in section 15.2.
  - When the power is turned to ON, the connection to the file server is restored.
-

## 15.4 Setting the Mail Transmission (SMTP Client Function)

This function can be used on products with firmware version 2.00 or later.

### Procedure

1. Press **SYSTEM**.
2. Press the **Network** soft key.
3. Press the **E-Mail Setup** soft key. The mail transmission setup menu appears.

### Setting the Mail Server

4. Press the **Mail Server** soft key.
5. Enter the host name or IP address of the mail server.

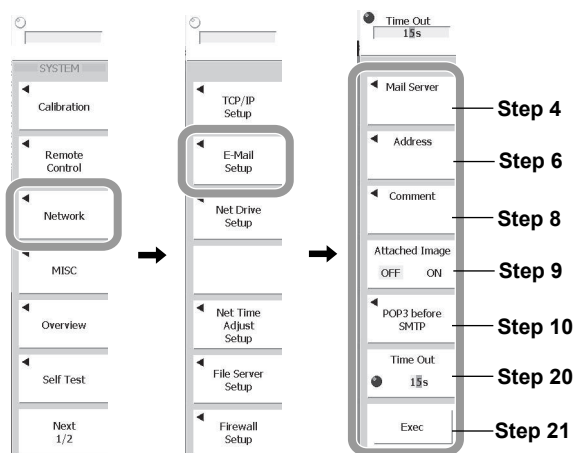

### Setting the Mail Address

6. Press the **Address** soft key.
7. Press the **To Address** and **From Address** soft keys and enter the sender and recipients mail addresses.

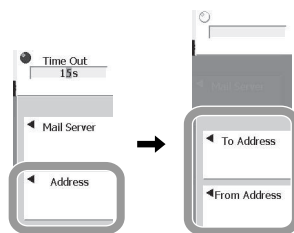

### Setting a Comment

8. As necessary, press the **Comment** soft key and enter a comment.

### Selecting Whether to Attach a Screen Image

9. Press the **Attached Image** soft key to select ON or OFF.

### Setting the User Authentication

10. Press the **POP3 before SMTP** soft key. The user authentication setup menu appears.
11. Press the **Mode** soft key to select ON or OFF.  
If you select ON, proceed to step 12. If you select OFF, proceed to step 19.
12. Press the **Type** soft key to select U/P or APOP.
13. Press the **POP3 Server** soft key.
14. Enter the host name or IP address of the POP3 server.
15. Press the **User Name** soft key. A screen appears for you to enter the user name.
16. Enter the user name using up to 30 characters.
17. Press **Password** soft key. A screen appears for you to enter the password.
18. Enter the password corresponding to the user name using up to 30 characters.
19. Press the **ESC** to return to the previous screen.

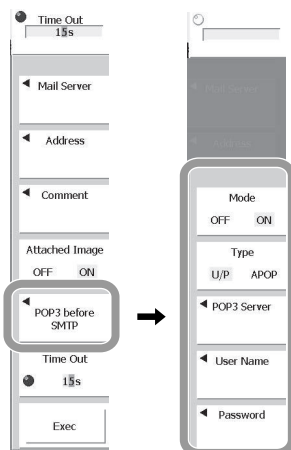

### Setting the Timeout Value

20. Turn the **rotary knob** to set the Time Out value.

### Sending the Mail

21. Press the **Exec** soft key. The mail is sent to the specified address.

#### **Note**

For the operating procedure of the keyboard (software keyboard), see section 4.2.

### Explanation

Information such as the trigger time can be sent to a specified mail address on the network as an action of action-on-trigger or GO/NO-GO determination.

#### **Mail Server**

Specify the IP address of the network mail server. On networks supporting WINS/DNS, you can specify the name (NetBIOS name or domain name) instead of the IP address.

#### **Address**

To Address: Set multiple recipients mail addresses using up to 100 characters. Separate each address with a comma.

From Address: Set the sender address using up to 40 characters. If you do not specify the sender address, the recipient address is set.

#### **Comment**

The comment is written on the first line of the transmitted mail. Enter it as necessary. You can enter a comment using up to 100 characters.

### Attached Image

The screen image shown at the time of mail transmission can be attached to the mail.

- File format: PNG
  - File name: DL\_image[date/time].png (example: DL Image060202171158.png → data at 11 hour 58 minutes on February 17, 2006)
  - Resolution: XGA (1024 × 768 dots)
  - File size (estimate)
    - Normal screen: Approx. 50 KB
    - Maximum: Approx. 1.6 MB\*
- \* When there is a lot of color information

### User Authentication (POP3 before SMTP)

POP3 user authentication is carried out before sending mail.

- **Mode**
  - ON: Carry out user authentication before sending mail
  - OFF: Do not carry out user authentication before sending mail
- **Encryption type**
  - U/P: Send authentication data in plain text.
  - APOP: Send authentication data by encrypting
- **POP3 Server**

Enter the host name or IP address of the POP3 server using up to 30 characters.
- **User Name**

Set the user name using up to 30 characters that is required when accessing the POP3 server from the DL9000.
- **Password**

Set the password using up to 30 characters that is required when accessing the POP3 server from the DL9000.

### Time Out

Set the transmission/reception timeout value. The selectable range is 1 to 60 s (default: 15 s, 1 s steps).

### Sending the Mail (Exec)

Send the mail to the specified mail address. If Attached Image is ON, the screen image that was shown when the Exec was pressed is attached.

---

### Note

- To use this function, you must configure TCP/IP according to the procedure given in section 15.2.
  - The DL9000 supports two authentication methods as user authentication methods of the POP3 server: plain authentication (U/P) and encrypted authentication (APOP\*).
    - \* APOP uses the MD5 algorithm (RSA Data Security, Inc. MD5 Message Digest Algorithm).
-

## 15.5 Using SNTP to Set the Date and Time

### Procedure

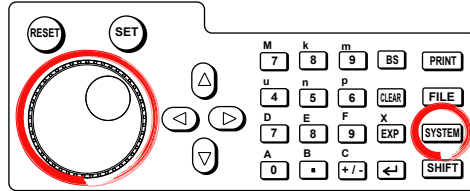

1. Press **SYSTEM**.
2. Press the **Network** soft key.
3. Press the **Net Time Adjust Setup** soft key. A menu appears for adjusting the time using SNTP.
4. Press the **Time Server** soft key. A window appears for setting the NTP/SNTP server IP address or host name.
5. Enter the IP address or host name of the NTP/SNTP server.
6. Press the **Power On Exec** soft key, to select ON or OFF.
7. With the **rotary knob**, set Time Out in the range 1 to 60 (s).
8. To set the date and time, Press the **Exec** soft key. The necessary information is obtained from the NTP/SNTP server to set the date and time on this unit.

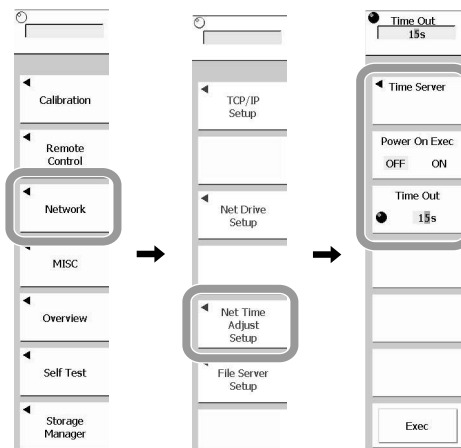

### Note

For the operating procedure of the keyboard (software keyboard), see section 4.2.

### Explanation

Time data is obtained over the network from an NTP/SNTP server, and used to set the date and time on this unit.

If Power On Exec is set to ON, the date and time information is obtained from the NTP/SNTP server connected to the network each time the unit is powered on.

### Note

The time difference from universal time (GMT) must be correctly set.

## 15.6 Accessing the DL9000 from a PC (File Server)

### Procedure

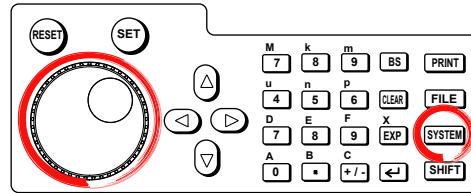

1. Press **SYSTEM**.
2. Press the **Network** soft key.
3. Press the **File/Web Server Setup** soft key.

### Selecting the File Server Function and Enabling/Disabling the Authentication Function

(Applicable to products with firmware version 1.80 or later.)

4. Press the **Type** soft key to display the Type menu.
5. Press the **Microsoft Network** or **FTP** soft key to select the file server function.
6. Press the **Mode** soft key to select ON or OFF.

### Setting the User Name and Password for Connecting to the DL9000 (When the Mode Is ON)

7. Press the **User Name** soft key to display a screen for entering the user name.
8. Enter the user name using up to 30 characters.
9. Press the **Password** soft key to display a screen for entering the password.
10. Enter the password corresponding to the user name using up to 15 characters.

If FTP is selected step 5, proceed to step 11.

If Microsoft Network is selected step 5, proceed to step 12.

### Allowing/Prohibiting Anonymous Login (FTP Server Only)

(Applicable to products with firmware version 1.80 or later.)

11. Press the **Allow Anonymous** soft key to select ON or OFF.

### Activating the Settings

12. Press the **Entry** soft key to enable the settings.  
The specified settings are activated only when you press Entry.

### Checking the Shared Folder

13. Press the **Shared Info** soft key. A list of shared storage media and folder names is displayed.
14. Press **ESC** to close the list.

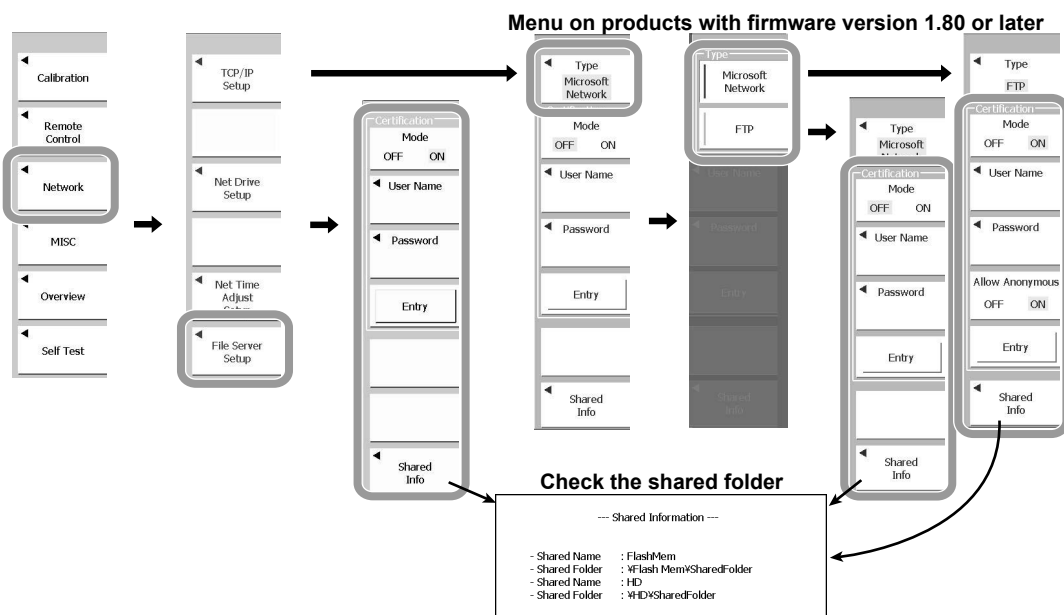

**Note** For the operating procedure of the keyboard (software keyboard), see section 4.2.

**Explanation**

The internal memory and internal hard disk (option) of the DL9000 can be accessed from a PC via the Ethernet network.

**File Server Function (Type)**

(Applicable to products with firmware version 1.80 or later. Microsoft Network is only supported on products with firmware version before 1.80.)

Select from the following:

- Microsoft Network: Access the internal memory or internal hard disk (option) of the DL9000 from a PC using the Microsoft Network function available on the PC.
- FTP: Access the internal memory or internal hard disk (option) of the DL9000 from a PC using an FTP client.

**Enabling/Disabling Authentication (Mode)**

Set whether to authenticate the access from the PC to the DL9000. If set to OFF, the DL9000 can be accessed without entering the user name and password.

**User Name**

Enter the user name that is required when accessing the DL9000 from a PC using up to 30 characters. The characters that can be used are all the ASCII characters on the keyboard.

**Password**

Enter the password that is required when accessing the DL9000 from a PC using up to 15 characters. The characters that can be used are all the ASCII characters on the keyboard.



## 15.6 Accessing the DL9000 from a PC (File Server)

---

### Allow Anonymous

(Applicable to products with firmware version 1.80 or later.)

This function is configured only when the FTP server function is set to FTP. Set whether to allow anonymous users to log into the DL9000.

- ON: Allows anonymous logins. The only file operation allowed is reading.
- OFF: Prohibits anonymous logins.

The table below shows the relationship between file server settings and the login access.

<b>Setting</b>						
File server function	Microsoft Network		FTP			
Authentication enable/disable	Disable	Enable	Disable	Enable		
User name and password	Not required	Required	Not required	Required		
Anonymous login allow/prohibit	—	—	Prohibit	Allow	Prohibit	Allow
<b>Login access</b>						
User login access	Yes	Yes	Yes	Yes	Yes	Yes
Anonymous login access	Yes	No	No	Yes	No	Yes
Login access only for anonymous (all other user names not allowed)	No	No	No	No	No	Yes*

\* Anonymous login is possible only when both user name and password are not set.

### Activating the Settings (Entry)

The specified settings are activated only when you press Entry.

### Shared Folder

The same shared folder is provided for both the Microsoft Network and FTP file server functions.

#### **Note**

---

- The PC must be running Microsoft Windows XP Home Edition or Professional to access the DL9000 using the Microsoft Network server function.  
If the following security update program (MS05-011) installed, problems may occur such as the file list display taking a long time or the DL9000 files not being able to copied to the PC.  
Patch: Windows XP security update program (KB885250), Date published: February 7, 2005, Version: 885250  
To work around this problem, contact Microsoft Customer Information Center, and install the following correction program in your PC.  
Correction program  
Article ID: 895900, Last Review: June 1, 2005, Revision: 2.0  
The information above does not pertain to the FTP server function.
  - The FTP server function on the DL9000 supports two authentication methods: plain authentication and encrypted authentication. The encrypted authentication uses OTP\* (One Time Password). FFFTP is a free FTP client that supports encrypted authentication.  
\* OTP uses the MD5 algorithm (RSA Data Security, Inc. MD5 Message Digest Algorithm).
  - Up to three clients can simultaneously use the Microsoft Network server function of the DL9000. Likewise, up to three clients can simultaneously use the FTP server function.
-

## 15.7 Monitoring the DL9000's Screen from a PC (Web Server)

### Procedure

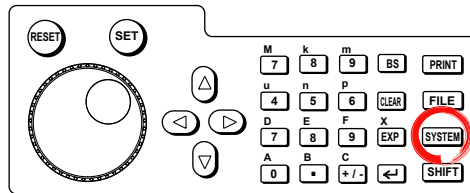

1. Press **SYSTEM**.
2. Press the **Network** soft key.
3. Press the **File/Web Server Setup** soft key.

### Selecting the Web Server and Enabling (ON)/Disabling (OFF) the Verification Function

4. Press the **Type** soft key. The Type menu appears.
5. Press the **Web** soft key.
6. Press the **Mode** soft key and select ON or OFF.

### Setting Up the User Name and Password for Connecting to the Instrument (When Mode is ON)

7. Press the **User Name** soft key. The user name entry screen appears.
8. Specify a user name using 30 characters or fewer.
9. Press the **Password** soft key. The password entry screen appears.
10. Specify a password corresponding to the user name using 15 characters or fewer.

### Note

For the operating procedure of the keyboard (software keyboard), see section 4.2.

### Applying the Settings

11. Press the **Entry** soft key. This settings are applied.  
If you do not press Entry, the settings will not take effect.

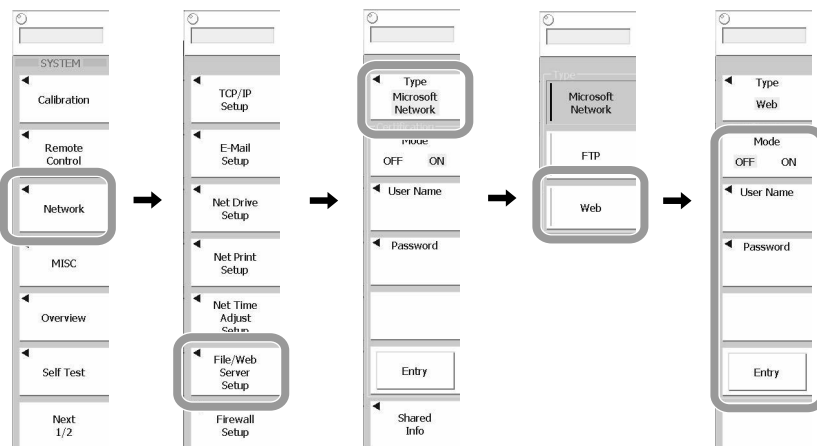

## 15.7 Monitoring the DL9000's Screen from a PC (Web Server)

### Connecting from a PC

Start the Web browser on a PC connected to the network.

Enter `http://xxx.xxx.xxx.xxx/` (where "xxx.xxx.xxx.xxx" is the IP address of the DL9000) in the browser's URL/Address box.

If verification is enabled on the DL9000, the user name and password entry dialog box appear. Enter the user name and password set in steps 7 through 10.

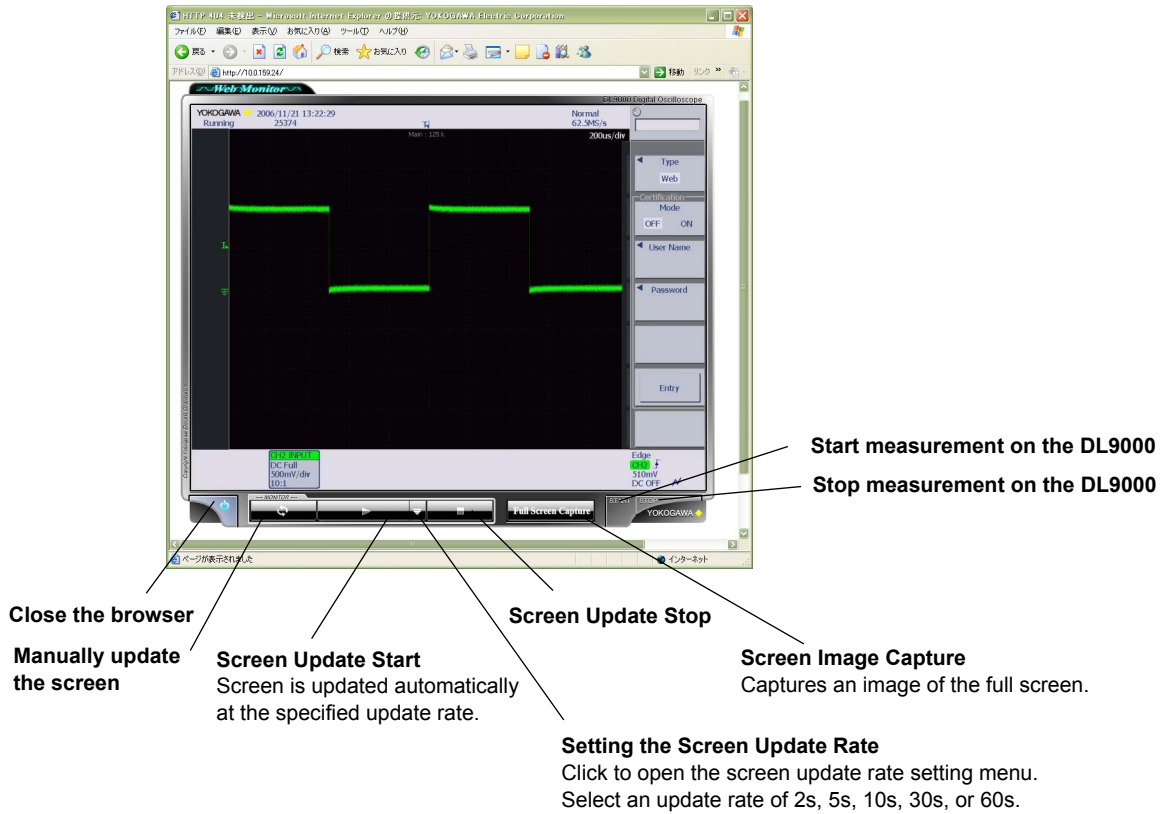

**Explanation**

You can display the instrument's screen and start or stop measurement from a PC on the network via Ethernet. You can also update the displayed screen or capture a screen image. Applies to products of firmware version 2.40 or earlier.

**Enabling/Disabling Verification: Mode**

You can set whether or not to verify users attempting to access the instrument from a PC. When turned OFF, the instrument can be accessed without entering a user name and password.

**User Name**

You can set the user name required to access the instrument from a PC, using 30 characters or fewer. All ASCII characters available on the keyboard can be used.

**Password**

You can set the password required to access the instrument from a PC, using 15 characters or fewer. All ASCII characters available on the keyboard can be used.

**Applying the Settings: Entry**

If you do not press Entry, the settings will not take effect.

**Recommended Operating Systems and Browsers**

OS	Web Browser
Windows XP Professional	Internet Explorer 6.0, Firefox 2.0
Windows 2000	Internet Explorer 6.0, Firefox 2.0
Macintosh OS/X (10.4.8)	Safari (2.0.4)

**Connection to the PC**

When connecting to the DL9000 from a PC using the Web server function, connect to the network via a hub or router. Do not connect the PC to the DL9000 in a one-to-one configuration.

**Note**

- Flash® Player by Adobe (version 8 or later) is required when using the Web server function. When visiting this Web site, the most recent Flash Player is automatically downloaded. If the download does not begin, please obtain the latest Flash Player from the Adobe Web site.
- When using the full screen capture function, be sure to disable pop-up blockers on your browser.
- The Web server function is unavailable when printing on the instrument or manipulating files.
- The Web server function can also not be used if the instrument is connected to a PC while the Mass Storage or TMC & Mass Storage setting is enabled on the PC. After disconnecting the PC or enabling the TMC setting, restart the DL9000.

## 15.8 Setting Up the Network Printer

### Procedure

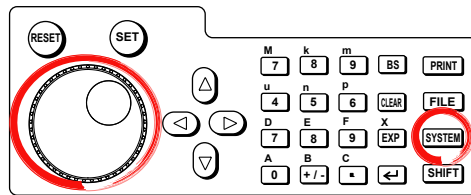

1. Press **SYSTEM**.
2. Press the **Network** soft key.
3. Press the **Net Print Setup** soft key.

### Set the Printer Server Name and Share Name

4. Press the **Print Server** soft key. A dialog box is displayed for setting the printer server name.
5. Set the printer server name.
6. Press the **Share Name** soft key. A dialog box is displayed for setting the printer server's share name.
7. Set the printer server's share name.

### Setting the User Name and Password for Connecting to the Network Printer

8. Press the **User Name** soft key. The user name entry screen appears.
9. Specify a user name using 30 characters or fewer.
10. Press the **Password** soft key. The password entry screen appears.
11. Specify a password corresponding to the user name using 30 characters or fewer.

For how to print out an actual DL9000 screen, see section 12.4.

### Note

For the operating procedure of the keyboard (software keyboard), see section 4.2.

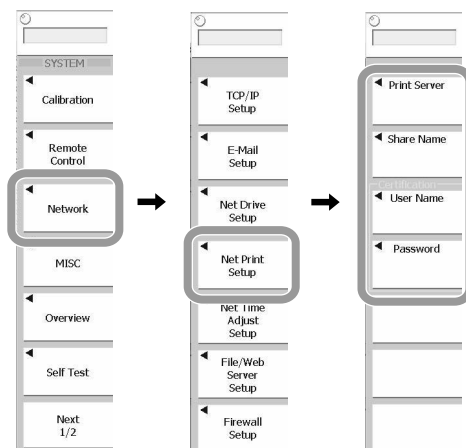

**Explanation**

You can connect to a Windows-based PC and print out data on a shared printer. Applies to products of firmware version 2.40 or earlier. Connections are shown in the following diagram.

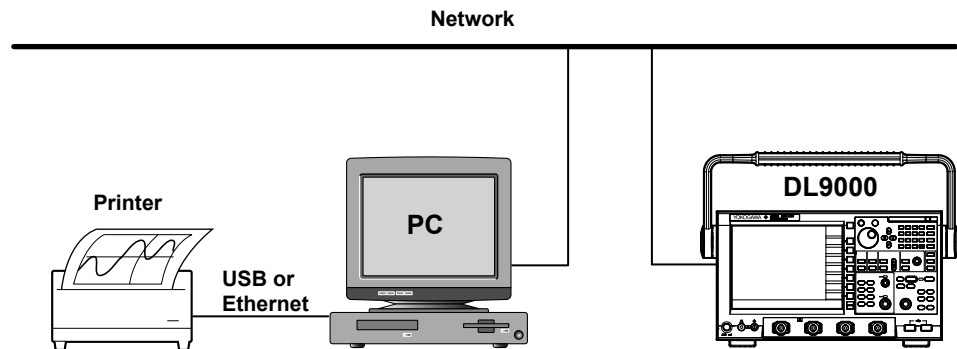

The supported PC operating systems are as follows.

Windows 2000

Windows XP Professional

**Note**

To use a network printer, the printer must be set for sharing on the PC. The following are instructions on how to share a printer using a PC running Windows XP Professional.

- From the Start menu, click Settings, and then click Printers and FAX.
- Right-click the icon of the printer to share, and click Share.

The following printers can be shared.

HP Inkjet printers

HP Laser printers (monochrome)

- Select the Share this printer option.
- Enter a share name (and enter this name as the share name in the DL9000).
- Click OK.

## 15.9 Checking the Presence of the Ethernet Interface

### Procedure

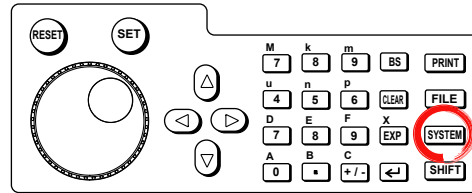

1. Press **SYSTEM**.
2. Press the **Overview** soft key. The Overview screen appears.
3. When Ether (/C10) or HDD+Ether (/C8) appears for the Option item in the Overview screen, this indicates that the Ethernet interface is installed.

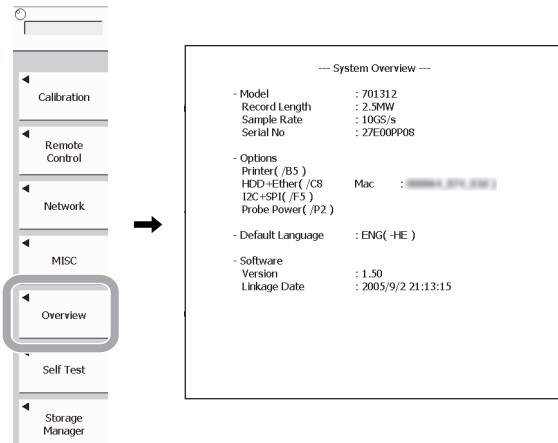

### Explanation

This function allows you to check the Presence of the Ethernet Interface.

#### Presence of Ethernet Interface

Ether (/C10) or HDD+Ether (/C8) appears in the Overview screen.

## 15.10 Configuring a Firewall

### Procedure

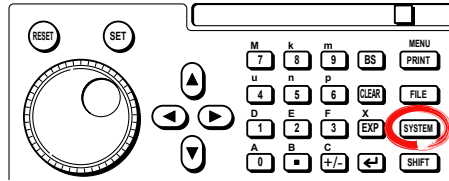

1. Press the **SYSTEM** soft key to display the SYSTEM menu.
2. Press the **Network** soft key.
3. Press the **Firewall Setup** soft key.

### Enabling/Disabling the Firewall

4. Press the **Mode** soft key to select ON or OFF.

### Allowing/Blocking Various Functions

- **Server Function**
  5. Press the **Microsoft Network** soft key to select Allow or Block.
  6. Press the **FTP** soft key to select Allow or Block.
  7. Press the **Control** soft key to select Allow or Block.
  8. Press the **Web** soft key to select Allow or Block.
- **Client Function**
  9. Press the **Client** soft key.
  10. Press the **E-Mail** soft key to select Allow or Block.
  11. Press the **Net Drive/Print** soft key to select Allow or Block.
  12. Press the **Net Time Adjust** soft key to select Allow or Block.

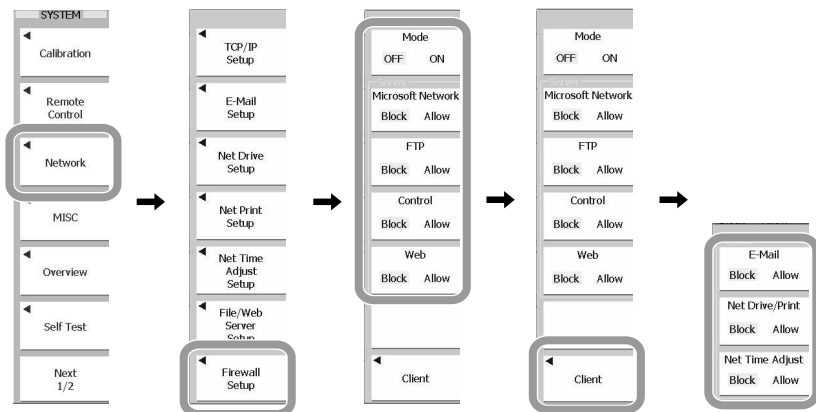



### Explanation

You can block access from other devices on the network to the DL9000 or access from the DL9000 to other devices. This function can be used on products with firmware version 1.80 or later.

#### Enabling/Disabling the Firewall

- ON  
Applies a firewall to the individual functions set to Block and prohibits access. (See the next subheading “Allowing/Blocking Various Functions” for the individual functions.) In addition ping and ICMP messages are blocked.
- OFF  
Allows access regardless of the settings explained in the next subheading. The following ports are used.

#### List of Used Ports

Port	Service	Function Type [Client/Server]
21/tcp	File Transfer [Control]	Client, Server
25/tcp	Simple Mail Transfer	Client
53/udp	Domain Name Server	Client
67/udp	Bootstrap Protocol Server	Client
110/tcp	Post Office Protocol Version3	Client
80/tcp	World Wide Web HTTP Server	Server
123/udp	Network Time Protocol	Client
137/udp	NETBIOS Name Service	Client, Server
138/udp	NETBIOS Datagram Service	Client, Server
139/tcp	NETBIOS Session Service	Client
445/tcp	Microsoft-DS	Server
10001/tcp	Control Server	Server

#### Allowing/Blocking Various Functions

A firewall can be set up for each function used in the Ethernet communication.

- Microsoft Network  
Allow or block access to the DL9000 using the Microsoft Network client function.
- FTP  
Allow or block access to the DL9000 using the FTP client function.
- Web  
Allow or block access to the DL9000 using the Web client function
- Control  
Allow or block access to the DL9000 using the remote control client function.
- Web  
Allow or block access to the DL9000 using the web client function.
- Net Drive/Print  
Allow or block access the Microsoft Network server from the DL9000 network drive.
- Net Time Adjust  
Allow or block the DL9000 from accessing the NTP or SNTP server.
- E-Mail  
Allow or block the DL9000 from accessing the SMTP or POP server.

#### Note

---

**Limitation when Allow is selected for the FTP function**

Clients cannot access the DL9000 using passive mode.

---

## 16.1 External Trigger Input (TRIG IN)



### CAUTION

Do not input any signal not meeting the specification below. An excessive voltage, for example, may damage the DL9000.

#### External Trigger Input Connector

This connector is used when an external signal is used as a trigger source (see Section 6.7).



Item	Specifications
Connector type	BNC
Maximum input voltage	$\pm 40$ V (DC + AC <sub>peak</sub> ) or 28 V <sub>rms</sub> when the frequency is 10 kHz or less
Input frequency bandwidth	DC to 100 MHz
Input impedance	Approx. 1 M $\Omega$ , approx. 18 pF
Trigger sensitivity	0.1 V <sub>p-p</sub>
Trigger level	$\pm 2$ V (setting resolution 5 mV)

## 16.2 Trigger Output (TRIG OUT)



### CAUTION

Do not apply an external voltage to TRIG OUT output connector. Doing so can cause damage to the DL9000.

#### External Trigger Output Connector

A TTL level signal is output when a trigger is activated. The signal level is normally high and goes low when a trigger is activated.

⚠ TRIG OUT



Item	Specifications
Connector type	BNC
Output levels	5 V TTL
Logic	Goes low when trigger is activated, goes high when acquisition is completed
Output delay time	50 ns or less
Output hold time	Low level: 50 ns Minimum, High level: 50 ns Minimum

#### Trigger Output Circuit Diagram/Timing Chart

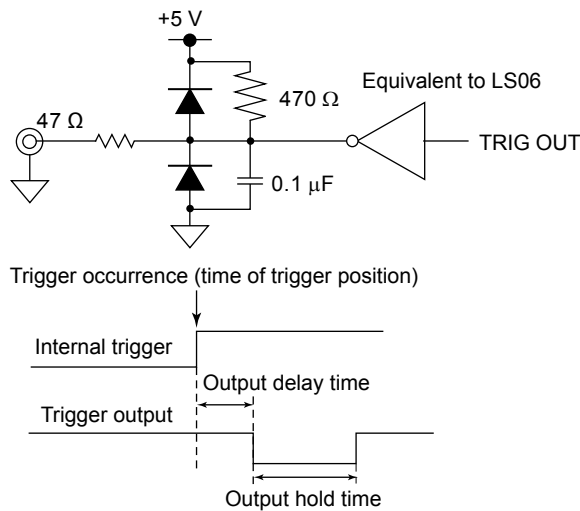

#### Low Level and High Level Hold Times

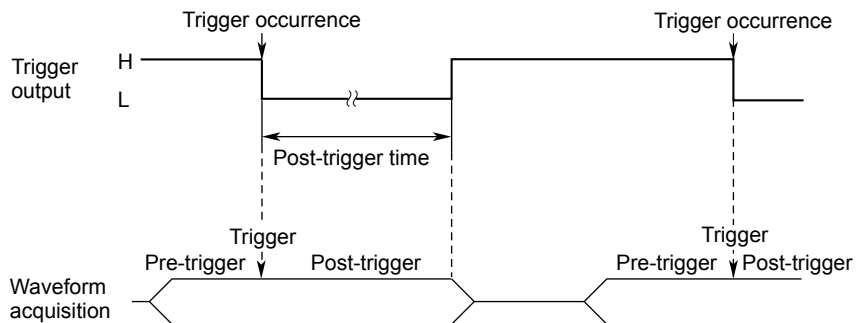

## 16.3 RGB Video Signal Output (RGB VIDEO OUT)



### CAUTION

- Power off the DL9000 and monitor before making the connection.
- Do not short the VIDEO OUT connector, or apply an external voltage. Doing so can cause damage to the DL9000.

#### Video Signal Output Connector

With the video signal output, the DL9000 screen display can be shown on a monitor. Any multisync monitor supporting XGA display can be connected.

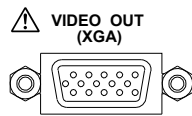

Item	Specifications
Connector type	D-sub 15-pin
Output format	Analog RGB output
Output resolution	1024 × 768 pixels, approx. 60 Hz Vsync

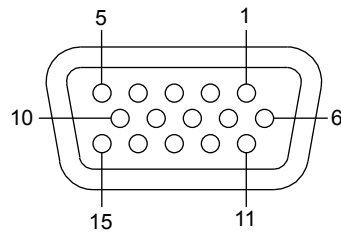

D-Sub 15-pin receptacle

Pin No.	Signal name	Specifications
1	Red	0.7 Vp-p
2	Green	0.7 Vp-p
3	Blue	0.7 Vp-p
4	—	
5	—	
6	GND	
7	GND	
8	GND	
9	—	
10	GND	
11	—	
12	—	
13	Horizontal sync signal	Approx. 36.4 kHz, TTL positive logic
14	Vertical sync signal	Approx. 60 Hz, TTL positive logic
15	—	

#### Connection to a Monitor

1. Power off the DL9000 and monitor.
2. Connect the DL9000 and the monitor using an analog RGB cable.
3. Power on the DL9000 and monitor.

## 16.4 GO/NO-GO Signal Output

The DL9000 can output a signal indicating a GO/NO-GO determination.

### Input/Output Connector

The connector uses a modular jack (RJ-12). A cable is available as optional accessory 366973.

Pin No.	Signal
1	NC (Not connected)
2	NC (Not connected)
3	GO OUT (Negative logic)
4	NO-GO OUT (Negative logic)
5	GND
6	NC (Not connected)

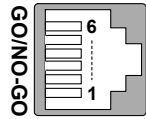

Connector on the DL9000

Input levels: TTL (0 to 5 V)

### GO/NO-GO Output Signal



#### CAUTION

- Do not apply an external voltage to the NO-GO OUT output pin or GO OUT output pin. Doing so can cause damage to the DL9000.
- When making the external connection to the GO/NO-GO determination signal output, be careful not to connect to a different signal pin. A wrong connection could result in damage to the DL9000 or to other connected equipment.
- Do not connect a USB cable to the GO/NO-GO output connector. Doing so can cause damage to the DL9000.

For connection to an external device, use the special-purpose optional accessory GO/NO-GO cable (part no.: 366973).

Do not use the special-purpose optional accessory GO/NO-GO cable (part no.: 366973) for any purpose other than a GO/NO-GO determination from the DL9000.

#### Specifications of the GO/NO-GO cable (model 366973)

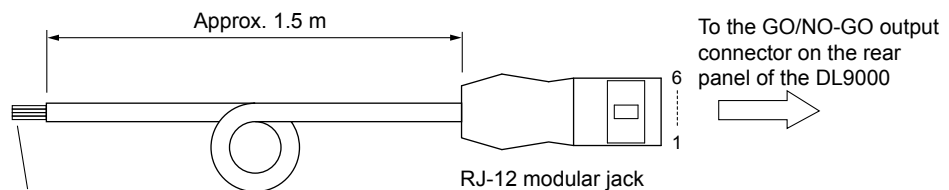

Wire ends are unfinished for modification as needed.

Wire color	Pin No.	Signal	Logic
White	3	GO OUT	Negative logic
Green	4	NO-GO OUT	Negative logic
Blue	5	GND	

**NO-GO OUT Signal**

When the determination result is “NO-GO”, the output signal level (TTL levels) goes temporarily from high level to low level.

**GO OUT signal**

When the determination result is “GO”, the output signal level (TTL levels) goes temporarily from high level to low level.

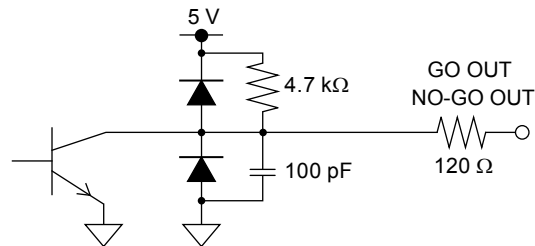
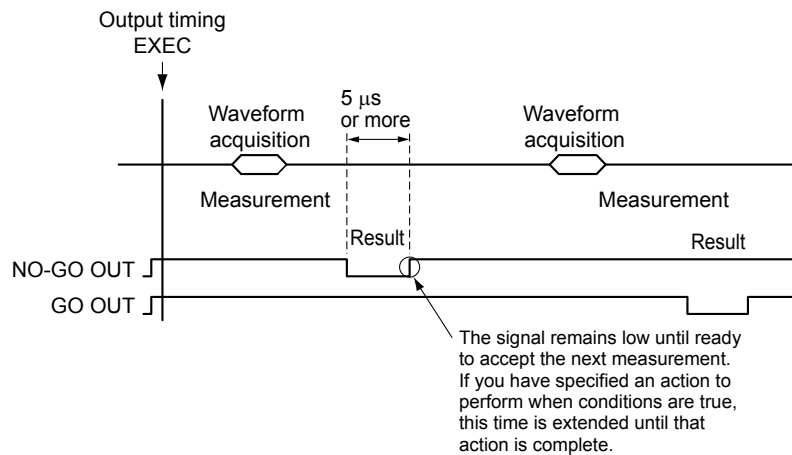
**Signal Output Circuit Diagram****GO/NO-GO Output Timing**

## 16.5 Trigger Comparator Signal Output



### CAUTION

- Power off the DL9000 before making the connection.
- Do not short the TRIG COMP OUT connector, or apply an external voltage. Doing so can cause damage to the DL9000.

### Trigger Comparator Signal Output Connector

Pin No.

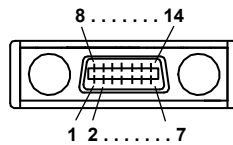

Item	Specifications
Output level	3.3 V LVPECL (difference output)
Output logic level	Negative logic
Output delay time	Max. 50 ns
Output hold time	Low level 50 ns min, High level 50 ns min
Output voltage	3.3 V (max. 300 mA)

Pin No.	Signal name	Pin No.	Signal name
1	CH1 trigger comparator output (L)	8	CH3 trigger comparator output (L)
2	CH1 trigger comparator output (H)	9	CH3 trigger comparator output (H)
3	CH2 trigger comparator output (L)	10	CH4 trigger comparator output (L)
4	CH2 trigger comparator output (H)	11	CH4 trigger comparator output (H)
5	Trigger enable output (L)	12	Trigger output (L)
6	Trigger enable output (H)	13	Trigger output (H)
7	3.3 V	14	GND

The trigger output signal is output with the same timing as TRIG OUT.

The trigger enable signal is output with the timing for enabling the trigger.

The trigger comparator output signals for channels 1 to 4 are output according to the trigger condition settings for the corresponding channel.

### Interface Cable

For connection, use the trigger compare output cable (701976) for the DL9000.

# 17.1 Changing the Message Language, Menu Language, and Font Size, and Turning ON/OFF the Click Sound

## Procedure

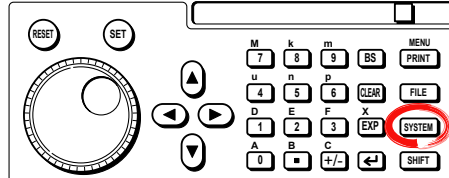

1. Press **SYSTEM**.
2. Press the **MISC** soft key.

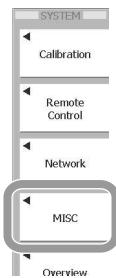

### Selecting the Message Language

3. Press the **Message** soft key.
4. Press the **ENG, JPN, CHN, or KOR** soft key to select the language. (CHN is available on products with firmware version 1.80 or later.)

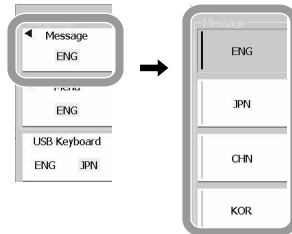

### Selecting the Menu Language and Font Size

The selecting function of Menu Language can be used on products with firmware version 1.80 or later.

The selecting function of Font Size can be used on products with firmware version 2.82 or later.

- **Selecting the Menu Language**
  3. Press the **Menu** soft key to display the Menu menu.
  4. Press the **ENG, JPN, CHN, or KOR** soft key to select the language.

- **Selecting the Font Size**
  5. Press the **Menu Font Size** soft key to select Small or Large. The font size of the alphanumeric characters on the menu changes.

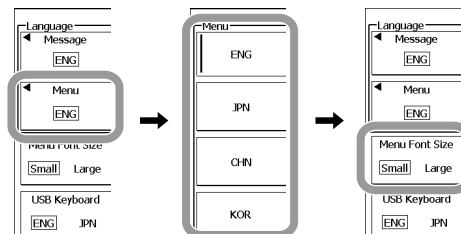



## 17.1 Changing the Message Language, Menu Language, and Font Size, and Turning ON/OFF the Click Sound

### Turning the Click Sound ON/OFF

3. Press the **Click Sound** soft key to select ON or OFF.

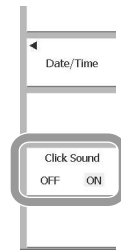

### Explanation

#### Selecting the Message Language

A message appears when an error occurs or when you press the HELP key. You can select the message language from English (ENG), Japanese (JPN), Chinese (CHN), and Korean (KOR). The messages codes are common in all languages. For a description of the messages, see section 18.2.

#### Selecting the Menu Language

Select the menu language from English (ENG), Japanese (JPN), Chinese (CHN) and Korean (KOR).

#### Selecting the Font Size

You can set the size of the alphanumeric characters on the menu to small or large. You can change the font size of the alphanumeric characters even if the menu language is set to a language other than English.

#### Turning the Click Sound ON/OFF

You can enable or disable the click sound that is generated when the rotary knob is turned. The default setting is ON.

#### **Note**

---

Chinese is available on products with firmware version 1.80 or later, Korean is available on products with firmware version 2.00 or later.

---

## 17.2 Listing the Setup Data

### Procedure

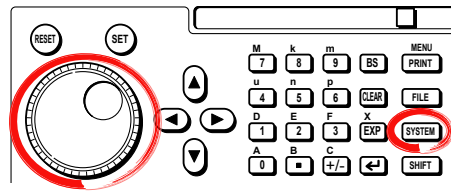

1. Press the **SYSTEM** soft key.
2. Press the **Next 1/2** soft key.
3. Press the **Setup Information** soft key to display a list of setup data.
4. Turn the **rotary knob** to select the page you want to display in the list.

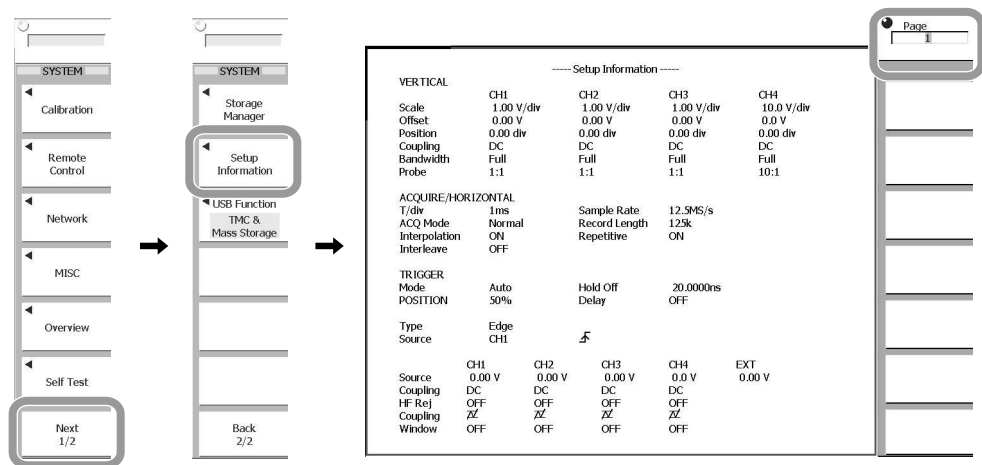

### Explanation

A list of setup data can be displayed. The list is displayed across multiple pages. This function can be used on products with firmware version 1.80 or later.

## 17.3 Changing the USB Keyboard Language

### Procedure

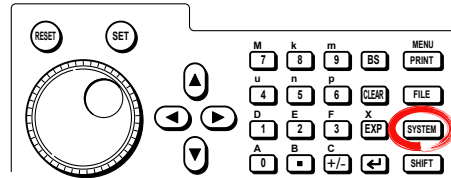

1. Press **SYSTEM**.
2. Press the **MISC** soft key.
3. Press the **USB Keyboard** soft key to select ENG or JPN

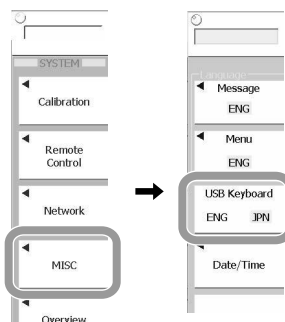

### Explanation

You can select the language of the USB keyboard that is used to enter items such as file names and comments (see section 4.3).

Applies to products of firmware version 2.40 or later.

For DL9000s with firmware version before 2.40, set the USB keyboard language according to the instructions in section 17.1.

Message language	Keyboard language
JPN	Japanese
Except JPN	English

Keyboards conforming to USB Human Interface Devices (HID) Class Version 1.1 can be used.

- ENG: 104 keyboard
- JPN: 109 keyboard

The character that is entered through each key of the 104 keyboard varies depending on the keyboard type. For details of 104 keyboard, see appendix 3.

## 18.1 If a Problem Occurs

### Faults and Corrective Action

- If a message appears on the screen, read the following pages.
- If service is required, or the corrective action does not solve the problem, refer to your supplier.

Description	Probable Cause	Corrective Action	Reference Section
The power cannot be turned ON.	Using a power supply outside the ratings.	Use a correct power supply.	3.3
Nothing is displayed.	The backlight is turned OFF.	Press any key.	8.4
	The screen colors are not appropriate.	Turn the power OFF, and then turn the power ON again while pressing the <b>RESET</b> key.	4.4
The display is odd.	The system is not operating properly.	Power-cycle the DL9000.	3.3
Keys do not work.	The keys are malfunctioning.	Perform a key test. If the test fails, servicing is required.	18.3
Trigger does not activate.	The trigger settings are not appropriate.	Set the trigger conditions correctly.	Chapter 6
Measured values are not correct.	Insufficient warm-up.	Warm up the DL9000 for 30 minutes after turning on the power.	–
	Not calibrated.	Execute calibration.	4.8
	The probe's phase has not been corrected.	Perform phase correction correctly.	3.5
	The probe attenuation is not correct.	Set an appropriate value.	5.6
	An offset voltage is added.	Set the offset voltage to 0 V.	5.2
	Other causes.	Execute calibration. If the measured value is still odd, servicing is required.	4.8
Cannot output to the built-in printer.	The printer head is damaged or worn out.	Servicing required.	–
Cannot save to the specified medium.	The medium is not formatted.	Format the medium.	18.6
	No more free space on the medium.	Delete unneeded files or use another storage medium.	–
Cannot change settings or control the operation of the DL9000 via the communication interface.	The address of the DL9000 used by the program is different from the specified address.	Match the address used in the program to the address of the DL9000.	Communication Interface User's Manual (IM 701310-17)
	The interface is not used in a way that conforms to the electrical or mechanical specifications.	Use it in a way that conforms to the specifications.	

## 18.2 Messages and Corrective Actions

### Error Messages

Messages may appear on the screen during operation, and this section explains these messages, and corrective action to take. Note that the messages can be displayed in either Japanese or English (See Section 17.1). If the corrective action requires service refer to your supplier.

In addition to the following error messages, there are also communications related error messages. These are described in the separate Communications Interface User's Manual (IM 701310-17).

### Information Errors

Code	Message and corrective action	Section
51	Turned on pressing the RESET key. All the settings will be initialized.	4.4
52	Firmware is updated. All the settings are initialized.	–
53	Hardcopy is aborted.	–
54	File access is aborted.	–
55	Action-on-trigger is aborted.	7.8
56	Search aborted.	–
57	Search execution is completed, but no record was found that matched the conditions.	–
58	Search execution is completed, but no record was found that matched the pattern.	–
59	Statistical measurement is aborted.	Chapter 10
62	The corresponding field was not found.	–
63	Action-on-trigger is completed.	7.8

### File Errors

Code	Message and corrective action	Section
500	Data size larger than remaining capacity in media. Delete unnecessary files or use other media.	Chapter 13
501	File does not exist. Check the file name.	Chapter 13
502	Assigned path does not exist or no media. Check the path name and media.	Chapter 13
503	Writing prohibited in the media. Unlock write protection of the media.	Chapter 13
504	Insufficient remaining capacity in media. Delete unnecessary files or use other media.	Chapter 13
505	File not compatible. Check the file, firmware version of the unit or model name of the unit.	–
506	Save data do not exist. Check the content to be saved.	–
507	Save data do not exist. Check the content to be saved.	–
508	Unable to open file. The may be opened by other process. Try to open file later. If the problem still exist, service may be necessary.	Chapter 15
509	Access denied.	Chapter 13
510	File system error. Service is required.	–
511	Media error. Service is required.	–

## 18.2 Messages and Corrective Actions

Code	Message and corrective action	Section
512	Directory can not be deleted.	Chapter 13
513	File or Directory can not be moved to other media. If the problem occurs on other media, service may be required.	Chapter 13
514	Directory entry does not exist.	–
515	Media error. Service is required.	–
516	Media error. Service is required.	–
517	End of the file.	–
518	The same file or directory name exist. Remove the file/directory or change the current path.	Chapter 13
519	Target file of Move or Copy has a read only property.	Chapter 13
520	Assigned path does not exist or no media. Check the path name and media.	Chapter 13
521	Destination folder assigned to Copy / Move is the same as the origin or sub folder. Change the destination folder.	Chapter 13
522	No file name. Type in file name.	Chapter 13
523	Auto file name failure. Change the type of auto file name or change the header of the auto name.	Chapter 13
524	Auto file name failure. Change the type of auto file name or change the header of the auto name.	Chapter 13
525	Improper file or path name. Check file/path name.	Chapter 13
526	File is disintegrated. Check the file.	–
527	File system error. Service is required.	–
528	Illegal file name. The name contains prohibited characters. Change it to a different name.	Chapter 13
529	Illegal file name. The name is reserved by the system. Change it to a different name.	Chapter 13
530	Load failure. Number of vortex exceeded the maximum. Redefine the mask data.	–
531	Unable to open file. The may be opened by other process. Try to open file later. If the problem still exist, service may be necessary.	–
532	Unable to save. Compressed record size exceeded current record size. Change the compressed record size and execute again.	–
533	Assigned path does not exist. Check the network setting and configuration.	Chapter 15
534	Assigned path does not exist. Check the network setting and configuration.	Chapter 15
535	Assigned path does not exist. Check the network setting and configuration.	Chapter 15

## 18.2 Messages and Corrective Actions

---

### Printer Errors

<b>Code</b>	<b>Message and corrective action</b>	<b>Section</b>
550	Printer error. Confirm the printer status.	–
551	Cannot detect printer. Turn ON the printer. Check connections.	–
552	Communication error. Check all connections and make sure all devices are on.	–
553	Paper not loaded correctly. Set the paper correctly.	12.1
554	Printer over heat. Power off immediately.	–
555	Move the release arm to the "HOLD" position.	12.1
556	No built-in printer on this model. Check the specifications to see whether or not the optional printer is provided.	Page ii

### Network Errors

<b>Code</b>	<b>Message and corrective action</b>	<b>Section</b>
600	Invalid network parameter settings. Check the network parameters.	Chapter 15
601	Unable to connect to the server. Check the network settings and configuration.	Chapter 15
602	Invalid file server settings. Check the file server settings.	Chapter 15
603	Invalid fire wall settings. Check the fire wall settings.	Chapter 15

## Execution Errors

Code	Message and corrective action	Section
650	Running. Stop and execute again.	4.7
651	Accessing file. Abort or wait until it is completed, and execute again.	–
652	Printing. Abort or wait until it is completed, and execute again.	–
653	Processing action-on-trigger. Abort or wait until it is completed, and execute again.	7.8
654	Processing zoom search. Abort or wait until it is completed, and execute again.	10.5
655	Processing auto scroll. Abort or wait until it is completed, and execute again.	–
656	Processing history search. Abort or wait until it is completed, and execute again.	Chapter 11
657	Processing history replay. Abort or wait until it is completed, and execute again.	Chapter 11
658	Processing statistical measurement. Abort or wait until it is completed, and execute again.	10.3
660	Zone edit in process. Terminate editing.	Chapter 7
661	Processing self test. Wait until it is completed.	–
662	Acquisition in process in N Single trigger mode. Press Start/Stop key or wait until the process is completed.	Chapter 6
663	Retrievable settings does not exist. The settings is created by either Initialize or Auto Setup.	–
664	Failed to execute statistical measurement. Waveform data may not exist. In Cycle statistic mode, improper setting may result in failure to recognize the cycle.	10.3
665	Search target data does not exist. The search after analysis is completed.	–
666	Improper action setting. The saved data type is either Waveform group or Analysis group. This can be assigned from File menu.	Chapter 13
667	Retrievable data not found.	–
669	Sending E-Mail. Wait until it is completed.	–
674	Cannot store because the data is locked. Release the lock through Store Detail.	4.6



## 18.2 Messages and Corrective Actions

---

### Setting Error

<b>Code</b>	<b>Message and corrective action</b>	<b>Section</b>
800	Improper Date/Time setting.	3.6
801	Not allowed unless waveforms are shown. Display waveforms.	Chapter 5
802	Source waveforms do not exist. Display source waveforms.	Chapter 7
803	Zone waveforms do not exist.	Chapter 7
804	Illegal expression.	Chapter 9
805	Not allowed in Telecom test mode. Turn off the Telecom test mode.	10.7

### System Errors

<b>Code</b>	<b>Message and corrective action</b>	<b>Section</b>
900	Failed to backup setup data. Initializing will be executed. Backup battery may be low. Maintenance service is required to replace the back-up battery.	18.7
901	Fan stopped. Power off immediately. Maintenance service is required.	18.7
902	Backup battery is low. Maintenance service is required to replace the back-up battery.	18.7
903	Calibration failure. Disconnect the input and execute again. If it fails again, service is necessary.	–

## 18.3 Carrying Out a Self-Test

### Procedure

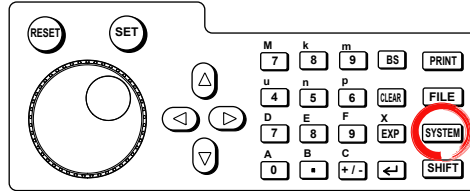

### Displaying the Self-Test Menu

1. Press **SYSTEM**.
2. Press the **Self Test** soft key.
3. Press the **Test Item** soft key.
4. With the soft keys, select the self-test item.

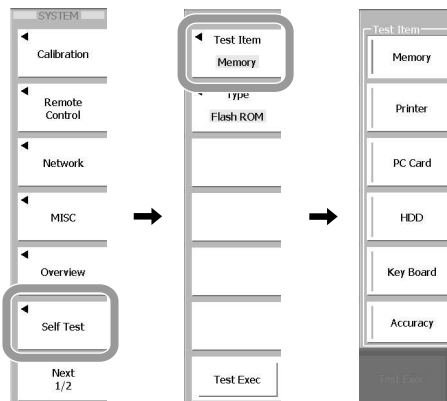

### Memory Test Execution

5. In step 4, select Memory.
6. Press the **Type** soft key.
7. With the soft keys, select memory.
8. Press the **Test Exec** soft key. This executes the memory test.

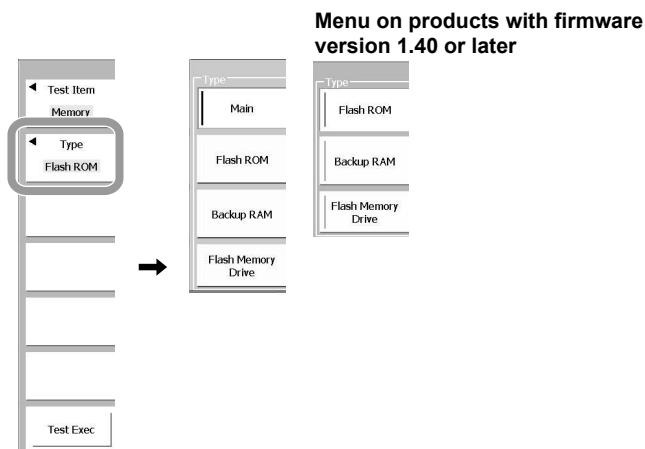

### 18.3 Carrying Out a Self-Test

#### Printer/PC Card/Internal HDD/Accuracy Test Execution

5. In step 4, select one of Printer, PC Card, HDD, and Accuracy.
6. Press the **Test Exec** soft key. This executes the respective test.

#### Note

Before carrying out the PC card drive test, insert a PC card.

#### Panel Key Test

5. In step 4, select Key Board.
6. Press the **Test Exec** soft key. The panel key test screen appears.
7. Pressing an operating key shows the corresponding key on the screen in reverse video.
8. Press all of the keys, or press **ESC** twice in succession. This ends the key test.

#### Soft Key Test

5. In step 4, select Key Board.
6. Press the **Soft Key** soft key.
7. Using the **rotary knob** and **SET**, check that characters are correctly entered from the keyboard.

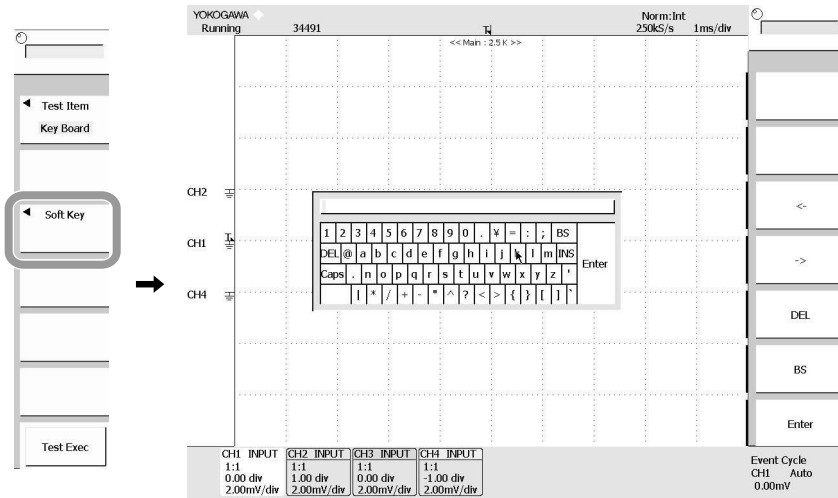

#### Note

The Accuracy test item is a test item for servicing.

**Explanation****Memory test: Memory**

This tests whether the RAM/ROM on the internal CPU board is operating correctly. A "Success" indication means that the result is normal. If there is an error, "Fail" appears.

**Printer test: Printer**

Tests whether the optional built-in printer is operating correctly. If the test pattern is printed correctly, then the printer is normal. If there is an error, the test pattern will not print correctly.

**PC card: PC Card**

Tests whether the PC card slot is functioning correctly. If there is an error, after test execution, "Fail" appears.

**Built-in hard disk drive (option /C8): HDD**

Tests whether the built-in hard disk drive is functioning correctly. If there is an error, after test execution, "Fail" appears.

**Key test: Key Board**

Tests whether the front panel operating keys are functioning correctly. If the name of a pressed key appears in reverse video, it is normal.

**Soft key test: Key Board**

Tests whether the soft keyboard is providing normal input. If the selected characters appear, then input is normal.

**Accuracy test: Accuracy**

This appears as a result of system autocalibration. If there is an error, "Fail" appears.

**If an error occurs in the self-test**

If the error persists after trying the following, refer to your supplier.

- Try running the self-test a number of times.
- Check that the media being tested is in place.
- Check that paper is correctly loaded in the built-in printer, and that there is no paper jam (Section 12.1).

## 18.4 System Overview

### Procedure

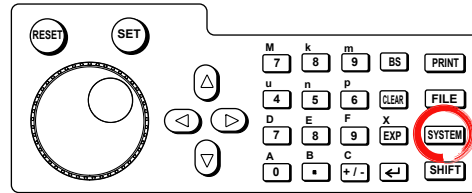

1. Press **SYSTEM**.
2. Press the **Overview** soft key. This switches to the overview screen. Press any key to exit the overview screen.

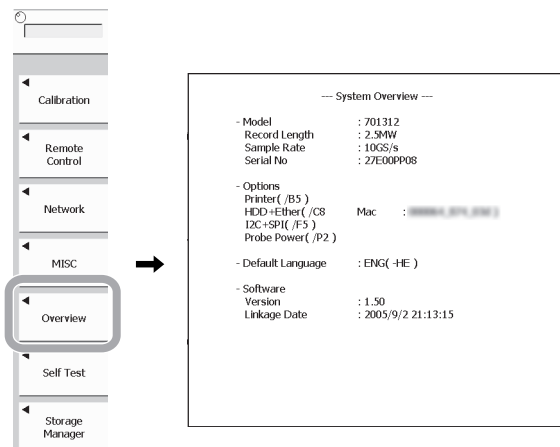

### Explanation

The screen appears as above, with the following information.

Model	Model
Record Length	Record length
Sample Rate	Maximum sample rate
Serial No.	Serial No.
Options	Installed options
Default Language	Default language
Software Version	Software version number
Linkage Date	Software version date

## 18.5 Collectively Deleting the Data in the Internal Memory and Built-in Hard Disk

### Procedure

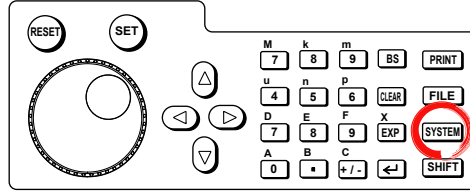

1. Press **SYSTEM**.
2. Press the **Storage Manager** soft key.
3. Press the **Sure Delete Exec** soft key. A message to confirm erasing the data appears.
4. With the **rotary knob** and **SET**, select OK or Cancel.  
If you select OK, all data in the internal memory and built-in hard disk is erased.  
The name of the Sure Delete Exec soft key changes to Abort while the data is being deleted.

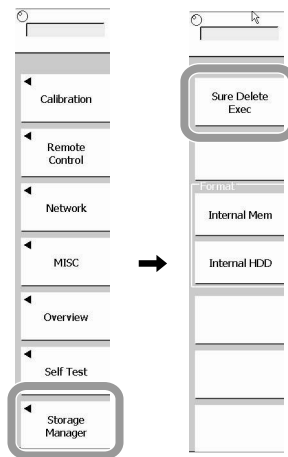

### Aborting Data Deletion

5. Press the **Abort** soft key. Data deletion is aborted. At the same time, the Abort soft key changes to the Sure Delete Exec soft key.

### Explanation

This function erases all data from the internal memory and built-in hard disk. Save required data on a PC card or other media.

### Note

To erase all data from the built-in hard disk takes approximately 2 hours 40 minutes.

## 18.6 Formatting Internal Memory and Built-in Hard Disk

### Procedure

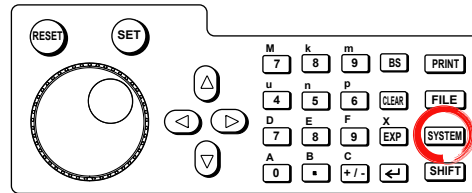

1. Press **SYSTEM**.
2. Press the **Storage Manager** soft key.
3. Press the **Internal Mem** or **Internal HDD** soft key. A message to confirm formatting appears.
4. With the **rotary knob** and **SET**, select OK or Cancel.  
If you select OK, the internal memory or built-in hard disk is formatted.

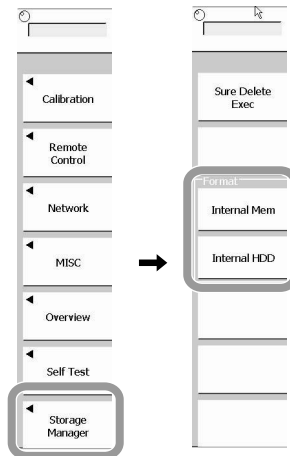

### Explanation

This formats the internal memory or built-in hard disk. Save required data on a PC card or other media.

## 18.7 Recommended Replacement Parts

Yokogawa guarantees the DL9000 for the period and under the conditions of the product warranty.

Under the conditions of the guarantee, the following components are excluded from the three-year warranty. For replacements, refer to your supplier.

<b>Part name</b>	<b>Lifetime</b>
Built-in printer	Under normal conditions of use, equivalent of 360 rolls of printer paper (part number: B9988AE)
LCD backlight	Under normal conditions of use, approx. 25,000 hours

<b>Part name</b>	<b>Guarantee period</b>
Built-in hard disk	One year from date of purchase (warranty does not cover loss of data).

The following parts are consumables. We recommend replacing them at the following intervals. For replacement parts, refer to your supplier.

<b>Part name</b>	<b>Recommended replacement interval</b>
Cooling fan	3 years
Backup battery (lithium battery)	5 years



## 19.1 Models

Item	Specifications		
Model name	Max. sample rate	Frequency bandwidth	Max. record length
DL9040 (701307)	5 GS/s	500 MHz	2.5 MW
DL9040L (701308)	5 GS/s	500 MHz	6.25 MW
DL9140 (701310)	5 GS/s	1 GHz	2.5 MW
DL9140L (701311)	5 GS/s	1 GHz	6.25 MW
DL9240 (701312)	10 GS/s	1.5 GHz	2.5 MW
DL9240L (701313)	10 GS/s	1.5 GHz	6.25 MW

## 19.2 Input Section

Item	Specifications			
Input channels	4 (CH1 to CH4)			
Input coupling setting	AC, DC, GND, DC50 $\Omega$			
Input connector	BNC connector			
Input impedance	1 M $\Omega$ $\pm$ 1.0% approx. 20 pF (10 M $\Omega$ $\pm$ 2.0% approx. 14 pF when using PB500 passive probe) 50 $\Omega$ $\pm$ 1.5%			
Voltage axis sensitivity setting range	For 1 M $\Omega$ input:	2 mV/div to 5 V/div (1-2-5 steps)		
	For 50 $\Omega$ input:	2 mV/div to 500 mV/div (1-2-5 steps)		
Maximum input voltage	For 1 M $\Omega$ input (at a frequency of 1 kHz or less):	150 Vrms CAT I		
	For 50 $\Omega$ input:	5 Vrms and 10 Vpeak (Not to exceed either of these values.)		
DC offset max. setting range (With probe attenuation factor set to 1:1)	For 1 M $\Omega$ input			
	2 mV/div to 50 mV/div:	$\pm$ 1 V		
	100 mV/div to 500 mV/div:	$\pm$ 10 V		
	1 V/div to 5 V/div:	$\pm$ 100 V		
	For 50 $\Omega$ input			
	2 mV/div to 50 mV/div:	$\pm$ 1 V		
	100 mV/div to 500 mV/div:	$\pm$ 5 V		
Vertical axis (voltage axis) accuracy				
DC accuracy <sup>1</sup>	For 1 M $\Omega$ input:	$\pm$ (1.5% of 8 div + offset voltage accuracy)		
	For 50 $\Omega$ input:	$\pm$ (1.5% of 8 div + offset voltage accuracy)		
Offset voltage axis accuracy <sup>1</sup>	2 mV/div to 50 mV/div:	$\pm$ (1% of setting value +0.2 mV)		
	100 mV/div to 500 mV/div:	$\pm$ (1% of setting value +2 mV)		
	1 V/div to 5 V/div:	$\pm$ (1% of setting value +20 mV)		
Voltage standing wave ratio (VSWR)	1.5 or less within frequency bandwidth (typical value <sup>4</sup> )			
Frequency characteristics <sup>1,2</sup> (-3 dB attenuation point when sine wave with amplitude $\pm$ 2 div equivalent is input)	For 50 $\Omega$ input	DL9040/DL9040L	DL9140/DL9140L	DL9240/DL9240L
	0.5 V/div to 10 mV/div:	DC to 500 MHz	DC to 1 GHz	DC to 1.5 GHz
	5 mV/div:	DC to 400 MHz	DC to 750 MHz	DC to 1 GHz
	2 mV/div:	DC to 400 MHz	DC to 600MHz	DC to 750MHz
	For 1 M $\Omega$ input (using PB500, measured from probe tip)			
	5 V/div to 10 mV/div:	DC to 500 MHz	DC to 500 MHz	DC to 500 MHz
	5 mV/div to 2 mV/div:	DC to 400 MHz	DC to 400 MHz	DC to 400 MHz
-3 dB low band attenuation point for AC coupling	10 Hz or below (1Hz or below using the supplied 10:1 probe)			
Skew between channels (with same setting conditions)	1 ns or below			
Residual noise level <sup>3</sup>	Larger of 0.4 mVrms or 0.05 div rms (typical value <sup>4</sup> )			
Isolation between channels (at same voltage axis sensitivity)	500 MHz model:	-34 dB at 500 MHz (typical value <sup>4</sup> )		
	1 GHz model:	-30 dB at 1 GHz (typical value <sup>4</sup> )		
	1.5 GHz model:	-30 dB at 1.5 GHz (typical value <sup>4</sup> )		
A/D conversion resolution	8 bits (25 LSB/div) Max. 12 bits (in high resolution mode)			

## 19.2 Input Section/19.3 Trigger Section

Item	Specifications
Probe attenuation factor settings	1 : 1, 10 : 1, 100 : 1, 1000 : 1, 10A : 1V, 100A : 1V (Attenuation selectable using the rotary knob only 2:1, 5:1, 20:1, 50:1, 200:1, 500:1, 1A:1V)
Bandwidth limit	For each channel, selectable from: FULL, 200 MHz, 20 MHz, 8 MHz, 4 MHz, 2 MHz, 1 MHz, 500 kHz, 250 kHz, 125 kHz, 62.5 kHz, 32 kHz, 16 kHz, and 8 kHz Provided by combination of analog filter (200 MHz, 20 MHz) and digital filter (IIR+FIR)
Maximum sample rate	DL9040/DL9040L/DL9140/DL9140L DL9240/DL9240L Realtime sampling mode With interleave mode on: 5 GS/s 10 GS/s With interleave mode off: 2.5 GS/s 5 GS/s Repetitive sampling mode: 2.5 TS/s 2.5 TS/s
Maximum record length	DL9040/DL9140/DL9240 DL9040L/DL9140L/DL9240L 2.5 MW 6.25 MW
Maximum acquisition rate	For 1.25 MW record length 60 waveforms/s/channel For 12.5 kW record length 9,000 waveforms/s/channel For 2.5 kW record length 25,000 waveforms/s/channel
Dead time for N single <sup>5</sup>	400 ns or less (equivalent to 2,500,000 waveforms/s for each channel)

- Values measured under standard operating conditions (see page 19-12) after 30-minute warm-up and calibration with the time base set to internal clock.
- Values for a repeating phenomena.  
The frequency bandwidth of a single burst frequency bandwidth is the smaller of the two values, DC to the sampling frequency/2.5 and the frequency bandwidth of the repeating phenomena.
- With the input section shorted, acquisition mode normal, interleave mode OFF, accumulate OFF, and probe attenuation set to 1:1.
- Typical values are typical or mean values. They are not strictly guaranteed.
- No change in the acquisition rate with an increase or decrease in the number of channels

## 19.3 Trigger Section

Item	Specifications
Trigger mode	Auto, Auto Level, Normal, Single, N-Single
Trigger source	CH1 to CH4: Signal applied to each input terminal LINE: Connected commercial power signal (can only be used for Edge trigger) EXT: Signal applied to the TRIG IN terminal
Trigger coupling	CH1 to CH4: DC/AC (except TV for TV trigger) EXT: DC
HF rejection	Select the bandwidth limit with respect to the trigger source (OFF, 15 kHz (DC to approx. 15 kHz), 20 MHz (DC to approx. 20 MHz)) (CH1 to CH4)
Trigger hysteresis	Select the trigger level hysteresis width (CH1 to CH4). Cannot be set for a channel using TV trigger. High: Apply a hysteresis of approx. 1.0 div around the trigger level Low: Apply a hysteresis of approx. 0.3 div around the trigger level
Trigger level setting range	CH1 to CH4: $\pm 4$ div from screen center, except 0.1 to 2 div for a TV trigger EXT: $\pm 2$ V (using 1:1 probe), $\pm 20$ V (using 10:1 probe)
Trigger level setting resolution	CH1 to CH4: 0.01 div, except 0.1 div for a TV trigger EXT: 5 mV (using 1:1 probe), 50 mV (using 10:1 probe)
Trigger level accuracy	CH1 to CH4 <sup>1</sup> : $\pm(0.2 \text{ div} + 10\% \text{ of trigger level})$ EXT <sup>2</sup> : $\pm(50 \text{ mV} + 10\% \text{ of trigger level})$
Window comparator	Selectable for each channel (CH1 to CH4) Center: $\pm 4$ divisions from the screen center Width: $\pm 4$ divisions around the center
Probe attenuation setting for external trigger	1:1 or 10:1
Trigger sensitivity	DL9040/DL9040L DL9140/DL9140L DL9240/DL9240L CH1 to CH4 <sup>1</sup> : 1 div <sub>P-P</sub> For DC to 500 MHz For DC to 1 GHz For DC to 1 GHz EXT <sup>2</sup> : 100 mV <sub>P-P</sub> For DC to 100 MHz For DC to 100 MHz For DC to 100 MHz Except Edge OR <sup>1</sup> : 1 div <sub>P-P</sub> For DC to 50 MHz For DC to 50 MHz For DC to 50 MHz

- Under standard operating conditions (see page 19-12) after warm-up and calibration.
- Under standard operating conditions after warm-up.

Item	Specifications
Trigger position	Can be set in 0.1% increments of the display record length
Trigger delay	<p>By time: Delay for a specified time after the trigger condition is met 0 to 10 s, minimum resolution 5 ps (depending on the sample rate)</p> <p>First edge after delay: Delay until the first specified edge after the specified time after the trigger condition is met 0 to 10 s, resolution 2 ns</p> <p>Edge Count: Delay until the specified number of specified edges after the trigger condition is met 1 to 10E9, in steps of 1</p>
Hold-off time setting range	20 ns to 10 s, resolution 5 ns
Trigger slope	Rising or falling
Trigger type	<p>Edge/State</p> <p>Edge: Activate a trigger on the edge of a single trigger source</p> <p>Edge(Qualified): Activate a trigger on the edge of a single trigger source while the qualify condition is met</p> <p>Edge OR: Activate a trigger on the logical OR of the edge conditions of multiple trigger sources (max. 50 MHz)</p> <p>State: Activate a trigger on the ENTER or EXIT condition when the state condition is met</p> <p>Width</p> <p>Pulse: Activate a trigger on the width of a single trigger source</p> <p>Pulse(Qualified): Activate a trigger on the width of a single trigger source while the qualify condition is met</p> <p>Pulse State: Activate a trigger on the width when the state condition is met</p> <p>Time width setting mode</p> <p>More than: Activate a trigger when the condition changes when the time during which the condition is met is longer than T1</p> <p>Less than: Activate a trigger when the condition changes when the time during which the condition is met is shorter than T1</p> <p>Between: Activate a trigger when the condition changes when the time during which the condition is met is longer than T1 and shorter than T2</p> <p>Out of Range: Activate a trigger when the condition changes when the time during which the condition is met is shorter than T1 or longer than T2</p> <p>Time out: Activate a trigger when the time during which the condition is met exceeds T1</p> <p>Setting time (T1/T2): 1 ns to 10 s, resolution 500 ps resolution</p> <p>Time accuracy: <math>\pm(0.2\%</math> of setting value + 1 ns)</p> <p>Event Interval</p> <p>Event: Edge, Edge(Qualified), State, Logic Edge, Logic Edge(Qualified), Logic State, Pulse, Pulse(Qualified), Pulse State, Logic Pulse, Logic Pulse State, Serial pattern, I<sup>2</sup>C, CAN, LIN, SPI (selectable as an event except TV and Edge OR)</p> <p>Event Cycle: Activate a trigger when the event cycle is within the specified time range</p> <p>Event Delay: Activate a trigger if the time interval between the event 1 occurrence and the first event 2 occurrence is within the specified time range</p> <p>Event Sequence: Activate a trigger when the first event 2 occurs within the specified time range after the event 1 occurrence</p> <p>Time width setting mode: Same as the time width setting mode of Width</p> <p>Setting time (T1/T2): 1.5 ns to 10 s, resolution 500 ps</p> <p>Time accuracy: <math>\pm(0.2\%</math> of setting value + 1 ns)</p>

### 19.3 Trigger Section

Item	Specifications
Enhanced	
TV:	Trigger on video signal in various TV systems Mode: NTSC, PAL, HDTV, USER Input channel: CH1 to CH4 Sync Guard: 60-90% of Hsync, in steps of 1% Line: 5 to 1054(NTSC), 2 to 1251(PAL), 2 to 1251(HDTV), 2 to 2048(USER) Field: 1, 2, X Frame Skip: 1, 2, 4, 8
Serial Pattern:	Trigger on general-purpose serial communications signal Maximum bit rate: 50 Mbps Maximum bit length: 128 bits
I2C:	Trigger on the I <sup>2</sup> C bus signal Mode: Every Start, ADR&DATA, NON ACK, General Call, Start byte, HS Mode
CAN:	Trigger on the CAN bus signal Mode: SOF, Error Frame, ID Std/Data, ID Ext/Data, ID/Data OR
LIN:	Trigger on the LIN bus signal Mode: Break
SPI:	Trigger on the SPI (Serial Peripheral Interface) bus signal Mode: 3wire, 4wire

## 19.4 Time Axis

Item	Specifications
Time axis setting range	500 ps/div to 50 s/div (1-2-5 steps)
Timebase accuracy <sup>1</sup>	±(0.001%)
Time axis measurement accuracy <sup>1</sup>	±(0.001% + 10 ps + 1 sample time)

1 Under standard operating conditions (see page 19-12) after warm-up.

## 19.5 Display Section

Item	Specifications
Display	8.4-inch (21.3 cm) color TFT liquid crystal display <sup>1</sup>
Display screen size	170.5 mm (width) × 127.9 mm (height)
Total display of pixels	1024 × 768 (XGA)
Waveform display pixels	800 × 640

1 The liquid crystal display may include few defective pixels (within 6 ppm with respect to the total number of pixels including RGB).

There may be few pixels on the liquid crystal display that do not turn ON all the time or remains ON all the time. Note that these are not malfunctions.

## 19.6 Functions

### Vertical and Horizontal Axis

Item	Specifications
Channel ON/OFF	CH1 to CH4 can be turned ON/OFF independently
Input filter	Place bandwidth limits on CH1 to CH4 independently
Vertical position setting	Move the waveform vertically by ±4 div from the center of the waveform area. Move the waveform until only the top signal or the bottom signal is displayed in the logic signal area.
Roll mode	Roll mode display is enabled when the trigger mode is set to Auto, Auto Level, or Single at the following time axis settings. 100 ms/div to 50 s/div

### Waveform Acquisition and Display

Item	Specifications
Acquisition mode	Selectable from normal, average, and envelope acquisition modes
High resolution mode	Vertical axis resolution increased up to 12 bits
Record length	DL9040/DL9140/DL9240 2.5 kW, 6.25 kW, 12.5 kW, 25 kW, 62.5 kW, 125 kW, 250 kW, 625 kW, 1.25 MW, 2.5 MW DL9040L/DL9140L/DL9240L 2.5 kW, 6.25 kW, 12.5 kW, 25 kW, 62.5 kW, 125 kW, 250 kW, 625 kW, 1.25 MW, 2.5 MW, 6.25 MW
Sampling mode	Switch between realtime sampling and repetitive sampling for some time axis settings.
Interleave mode	One input signal is sampled with two A/D converters, doubling the maximum sample rate.
Interpolation	Actual sampled data can be interpolated by a maximum factor of 1000 (2000 in high resolution mode), increasing the time resolution (max. 2.5 TS/s).
Accumulation	Waveform accumulation possible. Count mode and time mode selectable. Save and load are also possible.
Display format	Analog waveform divided into 1, 2, 3, or 4 displays
Display interpolation	Selectable from dot display of sample points, sine interpolation display, linear interpolation display, and pulse interpolation display
Graticule	Selectable from four types
Auxiliary display ON/OFF	Turn ON/OFF the scale values, waveform labels, and trigger marks
Snapshot	Retains the current displayed waveform on the screen
Zoom	See "Analysis and Search" below

## Analysis and Search

Item	Specifications
Cursor measurement	Selectable from five cursor types Vertical, Horizontal, VT, H&V, Marker, Serial
Automated measurement of waveform parameters	Following waveform parameters can be measured automatically. Items applicable to all setting range data, regardless of period: Max, Min, High, Low, P-P, Hi-Low, +Over, -Over, Rms, Mean, Sdev, IntegTY, V1, V2, ΔT Items applicable to all setting range data, related to period: C.Rms, C.Mean, C.Sdev, C.IntegTY, Freq, 1/Freq, Count, Burst Items applicable to first data found in setting range: +Width, -Width, Period, Duty, Rise, Fall, Delay
Zoom	Expand the waveform in the voltage axis (vertical) or time axis (horizontal) direction 2 locations at independent zoom rates Voltage axis magnification: ×1 to ×10 Time axis magnification: ×1 to 1 data value/div
Search & zoom	Search a part of the displayed waveform and display expanded Auto Scroll function: Automatically scrolls the zoom screen in the time axis direction. Search function: Search a specified part of currently displayed waveform from a specified time, and display in zoom window. Search Type: Edge, Edge(Qualified), State, Pulse, Pulse(Qualified), Pulse State, Serial Pattern, I <sup>2</sup> C(option), CAN(option), LIN(option), SPI(option)
History memory	Max. images: DL9040/DL9140/DL9240 1000 (with a record length of 2.5 kW) using history 800 (with a record length of 2.5 kW) using N single DL9040L/DL9140L/DL9240L 2000 (with a record length of 2.5 kW) using history 1600 (with a record length of 2.5 kW) using N single The number of history images do not change even if interleave mode is ON. History search: Search for and display waveforms from the history memory that satisfy specified conditions. Search type: Rect, WAVE, POLYGON, Parameter(Measure, FFT, XY) Replay: Automatically displays the history waveforms sequentially
Telecom test	Mask Test or Eye Pattern measurement
XY analysis	Display the phase relationship between two trace signals by specifying a trace for the X-axis (horizontal axis) and a trace for the Y-axis (vertical axis)
FFT analysis	FFT (Fast Fourier Transform) (max. 250 k points)
Waveform parameter analysis	Display a waveform parameter in the histogram, trend, or list format
Frequency distribution analysis	Displays a histogram of accumulated waveform data within the specified range
Serial bus signal analysis (option)	Analyzes and displays the data on the I <sup>2</sup> C, CAN, LIN, and SPI bus signals
Computation	CH1 to CH4, M1 to M4 +, -, *, Integ, Edge Count, Rotary Count, Filter (Through, Delay, Moving Avg, IIR Low Pass, IIR High Pass)  M1 to M4 CAN (option) Stuff Bit User-defined computation (option) Set equations by arbitrarily combining the following operators and constants. Operators: +, -, *, /, ABS, SQRT, LOG, LN, EXP, P2, -(negation), DELAY, BIN, SIN, ASIN, COS, ACOS, TAN, ATAN, DIFF, INTEG Constants: K1 to K4, 0 to 9, PI, e, fs, 1/fs, Exp, Measure Item Power supply analysis function (option) Standard computation, power, Z, I <sup>2</sup> t, and user-defined computation are possible
Reference function	Displays and analyzes (computation and cursor) up to 4 traces (M1 to M4) of saved waveform data. Load and replay history waveforms

Item	Specifications
Action-on-trigger	Acquire the waveform, perform determination using automated measurement of waveform parameters or waveform zone, and execute the selected action each time the the specified number of triggers is activated
Mode	<p>OFF</p> <p>Not execute the action.</p> <p>All Condition</p> <p>Acquire the waveform and execute the action</p> <p>GoNogo Zone/Param</p> <p>Determine whether the acquired waveform passes a specified zone or whether a specified parameter of the waveform enters within a specified range and execute the action</p> <p>Zone type: Rect, WAVE, and Polygon</p> <p>Param type: Measure, FFT, and XY</p> <p>GoNogo Telecom Test</p> <p>Determine whether the conditions specified in the Telecom Test is met and execute the action</p> <p>Category type: Mask Test and Eye Pattern</p>
Action	Beep, save/print the screen image, save the waveform data, or send mail (/C8 or /C10 option)

## Screen Image Data Printing/Storage

Item	Specifications
Built-in printer (option)	Print the screen image.
External printer	Output the screen image to an external printer via the USB or the Ethernet interface <sup>2</sup> Supports EPSON and HP (PCL) inkjet printers Only HP (PCL) supported for the Ethernet interface
PC card, internal memory, internal hard disk, <sup>1</sup> USB storage medium, Network drive <sup>2</sup>	Output data format: PNG, BMP, and JPEG

1 Internal HDD is an option.

2 When the Ethernet Interface option is installed.

## Data Storage

Item	Specifications
History memory	Automatically stores up to 2000 history waveforms (with a record length of 2.5 kW)
PC card, internal memory, internal hard disk, <sup>1</sup> USB storage medium, Network drive <sup>2</sup>	Saves waveform data, setup data, and various data

1 Internal HDD is an option.

2 When the Ethernet interface option is installed.

## 19.6 Functions/19.7 Built-in Printer (/B5 option)

---

### Miscellaneous

Item	Specifications
Setup	Initialize: Reset the settings to factory default values.
	Auto setup: Automatically set to the optimal settings for the input signal.
	CH auto scale: Automatically set only the voltage axis of the target trace to the optimal setting for the input signal.
	Store/recall: Store and recall up to 12 arbitrary setup data using the internal memory
Calibration	Auto calibration and manual calibration available.
Environmental settings	Set the screen color, date/time, message language, and click sound ON/OFF.
Overview	View system specifications.
Self-test	Perform a memory test, key test, printer test, etc.
Numeric keypad	Allows values to be entered directly.
Arrow keys	Move the cursor in all four directions.
Probe compensation signal output	Output a signal (square wave of approx. 1 Vp-p and approx. 1 kHz) from the probe compensation signal output terminal on the front panel.
Help function	Display explanation of the settings

---

## 19.7 Built-in Printer (/B5 option)

Item	Specifications
Print system	Thermal line dot system
Dot density	8 dots/mm
Paper width	112 mm



## 19.8 Auxiliary Inputs and Outputs

### External Trigger Input (TRIG IN)

Item	Specifications
Connector type	BNC
Input bandwidth <sup>1</sup>	DC to 100 MHz
Input impedance	Approx. 1 M $\Omega$ , approx. 18pF
Maximum input voltage	$\pm 40$ V (DC+ACpeak) or 28 Vrms at a frequency of 10 kHz or less
Trigger level	$\pm 2$ V (resolution: 5 mV)

1 Under standard operating conditions (see page 19-12) after warm-up.

### External Trigger Output (TRIG OUT)

Item	Specifications
Connector type	BNC
Output level	TTL (0 - 5V)
Output logic	Negative
Output delay time	50 ns max
Output hold time	Low level: 50 ns min, High level: 50 ns min

### Comparator Outputs (COMP OUT)

Item	Specifications
Connector type	12214-8210-00TA (manufacturer 3M)
Output connectors	14 (CH1-4 trigger comparator output, trigger out output, trigger enable output, 3.3 V, GND)
Output level	3.3 V LVPECL (difference output)
Output delay time	50 ns max
Output hold time	Low level: 50 ns min, High level: 50 ns min

### Probe Interface Terminal

Item	Specifications
Output terminals	4
Output voltage	$\pm 12$ V (up to total 1.2 A together with probe power terminal), $\pm 5$ V (up to total 800 mA)
Compatible probes	Active probe (701912/701913/701914), Differential probe (701923)

### Probe Power Terminal (/P2 option)

Item	Specifications
Output terminals	2
Output voltage	$\pm 12$ V (up to total 1.2 A together with probe interface terminal)
Compatible probes and deskew correction signal source	FET probe (700939), current probe (701932/701933), differential probe (700924/700925/701920/701921/701922), and deskew correction signal source (701935)

### GO/NO-GO Output

Item	Specifications
Connector type	RJ-12 modular jack
Signal types	GO OUT, NO-GO OUT
Output levels	TTL (0 - 5 V)
Compatible cable	Four-wire modular cable (366973)

### Video Signal Output (VIDEO OUT)

Item	Specifications
Connector type	15-pin D-Sub receptacle
Output format	Analog RGB output
Output resolution	Sub-XGA output 1024 × 768 pixels, approx. 60 Hz Vsync (dot clock frequency 62.5 MHz)

## 19.9 Storage

### Internal Memory

Item	Specifications
Media type	Compact Flash
Capacity <sup>1</sup>	32 MB

1 The capacity may change.

### Built-in Hard Disk (/C8 option)

Item	Specifications
Number of drives	1
Size	2.5-inch
Usable HDD capacity <sup>1</sup>	30 GB FAT32
File names	Long file names (up to 256 ASCII characters) supported

1 The capacity may change.

### USB Peripheral Interface

Item	Specifications
Connector type	USB type A connector (receptacle)
Electrical and mechanical specifications	USB Rev. 2.0 compliant
Supported transfer standards	LS (Low Speed) mode (1.5 Mbps), FS (Full Speed) mode (12 Mbps)
Supported devices <sup>1</sup>	USB HID Class Ver. 1.1 compliant mouse and 109-key keyboard (Japanese), 104-key keyboard (US) USB Printer Class Ver. 1.0 compliant, EPSON/HP (PCL) inkjet printers supported USB Mass Storage Class Ver. 1.1 compliant mass-storage devices USB HUB Device (one only) Up to four devices can be connected.
Ports	2
Power supply	5 V, 500 mA (each port)

1 For details on compatible devices, contact your nearest YOKOGAWA dealer.

## 19.10 Computer Interfaces

### PC card interface

Item	Specifications
Number of ports	2 (front panel × 1, rear panel × 1)
Compatible cards <sup>1</sup>	GP-IB card (option support) National Instruments NI PCMCIA-GPIB cards supported Storage cards Flash ATA memory cards (PC card TYPE II), CF card + adapter card, HDD-type PC cards

1 For details on compatible devices, contact your nearest YOKOGAWA dealer.

### USB-PC Connection

Item	Specifications
Connector type	USB type B connector (receptacle)
Electrical and mechanical Specifications	USB Rev. 2.0 compliant
Supported transfer standards	HS (High Speed) mode (480 Mbps), FS (Full Speed) mode (12 Mbps)
Number of ports	1
Supported protocol	Acts as a composite device simultaneously supporting the following two protocols. USBTMC-USB488 (USB Test and Measurement Class Ver. 1.0) <sup>1</sup> USB bus can be used with GPIB commands. Mass Storage Class Ver. 1.1 Access from a PC to the internal memory, built-in hard disk, PC card <sup>2,3</sup> , USB mass-storage device <sup>3</sup> is possible (reading and writing). However, formatting is not possible.
Compatible PC systems	A PC running Windows XP/2000 English/Japanese version, equipped with a USB port.

1 A separate driver is required.

2 No drivers are required.

3 For details on compatible devices, contact your nearest YOKOGAWA dealer.

### Ethernet Interface (/C8 or /C10 option)

Item	Specifications
Connector type	RJ-45 connector
Number of ports	1
Electrical and mechanical Specifications	IEEE802.3 compliant
Transmission method	Ethernet (100BASE-TX/10BASE-T)
Communications protocol	TCP/IP
Supported services	DHCP, DNS, Microsoft network file sharing server and client, SMTP client, SNMP client, FTP server, Web server, network printer, and firewall
LED indicators	2 indicators. Link (Yellow: lit when link is established), Activity (Green: lit while packets being transferred)

## 19.11 General Specifications

Item	Specifications
Standard operating conditions	Ambient temperature: 23 ±5°C Ambient humidity: 55 ±10%RH Power supply voltage and frequency tolerance: Within 1% of rated value
Warm-up time	At least 30 minutes
Storage conditions	Temperature: -20 to 60°C Humidity: 20 to 80%RH (no condensation)
Operating conditions	Temperature: 5 to 40°C Humidity: 20 to 80%RH (not using printer) (no condensation) 35 to 80%RH (using printer) (no condensation)
Recommended calibration period	1 year
Storage altitude	3000 m or less
Operating altitude	2000 m or less
Rated supply voltage	100 to 120 VAC or 220 to 240 VAC (automatic switching)
Power supply voltage fluctuation tolerance	90 to 132 VAC or 198 to 264 VAC
Rated supply frequency	50/60 Hz
Power supply frequency fluctuation tolerance	48 to 63 Hz
Power supply fuse	Internal (not replaceable)
Maximum power consumption	300 VA
Withstand voltage (between power supply and case)	1.5 kVAC, one minute
Insulation resistance (between power supply and case)	500 VDC, at least 10 MΩ
External dimensions	350(W) × 200(H) × 178(D) mm (with printer cover packed away, excluding handle and other projections)
Weight	Approx. 6.5 kg (including printer)
Cooling method	Forced air cooling, side ventilation
Installation orientation	Horizontal (stand or handle may be used). Vertical and stacking prohibited.
Battery backup	Setup data and clock are backed up with the internal lithium battery Battery life: Approx. 5 years (at ambient temperature 25°C)

Item	Specifications
Safety Standards	<p>Complying standards</p> <p>EN61010-1</p> <p>Overvoltage category of the signal input section: I (150 Vrms)<sup>1</sup></p> <p>Pollution degree 2<sup>2</sup></p>
Emission	<p>Complying standards</p> <p>EN61326 Class A, C-Tick AS/NZS CISPR11 (applies to 701307, 701308, 701310, 401311, 701312, 101313, 701913, 701923, 701943, and 701974 with 701975)</p> <p>EN61000-3-2</p> <p>EN61000-3-3</p> <p>This product is a Class A (for industrial environment) product. Operation of this product in a residential area may cause radio interference in which case the user is required to correct the interference.</p> <p>Cable condition</p> <p>External trigger input terminal(TRIG IN) Use a BNC cable<sup>3</sup> and attach a ferrite core (TDK: ZCAT2035-0930A, YOKOGAWA: A1190MN) on one end (DL9000 end).</p> <p>Trigger output terminal(TRIG OUT) Same as the external trigger input terminal above.</p> <p>Trigger comparator output terminal(TRIG COMP OUT) Use a Trigger comparator output cable(YOKOGAWA model 701976, sold separately). and attach a ferrite core (TDK: ZCAT2035-0930A, YOKOGAWA: A1190MN) on one end (DL9000 end).</p> <p>Video signal output connector (VIDEO OUT) Use a 15-pin D-Sub VGA shielded cable<sup>3</sup> and attach a ferrite core (TDK: ZCAT2035-0930A, YOKOGAWA: A1190MN) on one end (DL9000 end).</p> <p>USB connector for connecting peripheral devices Attach a ferrite core (TDK: ZCAT1325-0530A, YOKOGAWA: A1181MN) on one end (DL9000 end) of the USB cable.<sup>3</sup></p> <p>USB connector for connecting to a PC Attach a ferrite core (TDK: ZCAT1325-0530A, YOKOGAWA: A1181MN) on one end (DL9000 end) of the USB cable.<sup>3</sup></p> <p>GO/NO-GO output terminal Use a GO/NO-GO cable (YOKOGAWA model 366973, sold separately) and wind the cable twice around the ferrite core (TDK: ZCAT2035-0930A, YOKOGAWA: A1190MN) on one end (DL9000 end). See the figure below.</p> <p>Ethernet interface connector Use a Ethernet interface cable<sup>3</sup> and wind the cable twice around the ferrite core (TDK: ZCAT2035-0930A, YOKOGAWA: A1190MN) on one end (DL9000 end). See the figure below.</p>

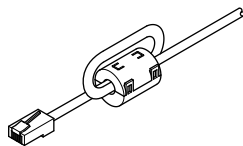

- 1 The instrument's expected transient overvoltage is 1500 V. Do not use the instrument for overvoltage category II, III, or IV measurements.
- 2 Pollution Degree applies to the degree of adhesion of a solid, liquid, or gas which deteriorates withstand voltage or surface resistivity. Pollution Degree 2 applies to normal indoor atmospheres (with only non-conductive pollution).
- 3 Use cables of length 3 m or less.

## 19.11 General Specifications

---

Item	Specifications
Immunity	<p>Complying standards</p> <p>EN61326 industrial environment (applies to 701307, 701308, 701310, 701311, 101312, 701313, 701913, 701923, 701943, and 701974 with 701975)</p> <hr/> <p>Influence in the immunity environment (performance criterion A)</p> <p>Noise increase: within <math>\pm 200</math> mV (when using 701943) within <math>\pm 200</math> mV (when using 701974 with 701975) within <math>\pm 2</math> V (when using 701913)</p> <p>Test conditions: When 5 GS/s, envelope mode, 20 MHz BWL (10:1 probe attenuation setting), and 50-<math>\Omega</math> termination at the probe tip.</p> <p>Cable condition: Same as the cable condition for emission.</p> <p>Test Item:</p> <ol style="list-style-type: none"><li>1. Electrostatic discharge: EN61000-4-2 Air discharge: <math>\pm 8</math> kV, contact discharge: <math>\pm 4</math> kV, criteria B</li><li>2. Radiated immunity: EN61000-4-3 80 M to 1 GHz, 1.4 G to 2 GHz, 10 V/m Criteria A</li><li>3. Conducted immunity: EN61000-4-6 3 V, criteria A</li><li>4. Electrical fast transient/burst : EN61000-4-4 Power line: <math>\pm 2</math> kV, signal line: <math>\pm 1</math> kV, criteria B</li><li>5. Power frequency magnetic field: EN61000-4-8 30 A/m, 50 Hz, criteria A</li><li>6. Surge immunity: EN61000-4-5 Between lines: <math>\pm 1</math> kV, common: <math>\pm 2</math> kV criteria B</li><li>7. Voltage dip and interruption: EN61000-4-11 0.5 cycle, both polarities, 100%, criteria A</li></ol> <p>Definitions of criteria A and B</p> <p>Criteria A: Aforementioned "Influence in the immunity environment" is met during the test.</p> <p>Criteria B: This apparatus continues to operate without hang-up or falling into uncontrollable conditions during the test. No change of actual operating state or stored data is allowed.</p>

---

# 19.12 External Dimensions

## Main unit

Units: mm

Unless otherwise specified, tolerances are  $\pm 3\%$  ( $\pm 0.3$  mm for dimensions less than 10 mm).

### Rear View

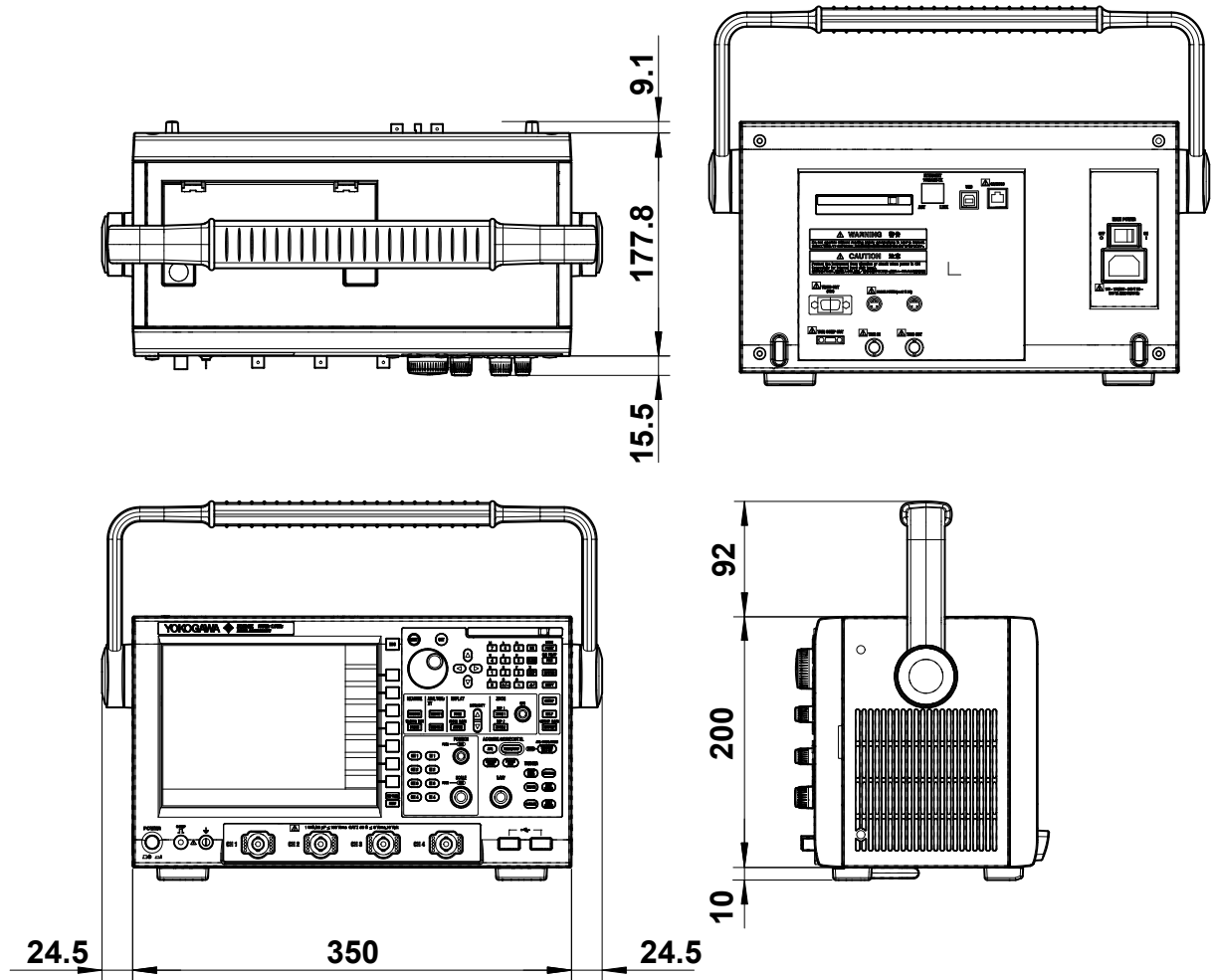

# Appendix 1 Relationship between the Time Axis Setting, Sample Rate and Record Length

## Overview

The sample rate and record length depend on the time axis setting, and whether repetitive sampling mode, interleave mode, data interpolation, and high resolution mode are on or off.

The DL9000 uses repetitive sampling and data interpolation to increase the effective sample rate above the maximum sampling rate. When the maximum sample rate is exceeded, the following processing is carried out.

### When data interpolation is on

- When the repetitive sampling mode is off, the data is interpolated to increase the sampling rate.
- When the repetitive sampling mode is on, if the time axis setting is 50 ns/div or below, and the sample rate is 500 GS/s or more, then repetitive sampling is carried out, and otherwise data interpolation is carried out.
- If the sample rate exceeds 2500 GS/s, 2500 GS/s is maintained, and the record length is reduced.

### When data interpolation is off

- When the repetitive sampling mode is off, the record length is reduced to increase the sample rate. If the record length is less than 100 words, repetitive sampling is carried out.
- When the repetitive sampling mode is on, repetitive sampling is carried out with the record length 1.25 M words or below (6.25 k words or below for the DL9040, DL9140, and DL9240).
- When the settings are such that the sample rate exceeds 2500 GS/s, 2500 GS/s is maintained, and the record length is reduced.

Regardless of whether data interpolation is on or off, the minimum sample rate is 50 S/s.

The following pages show examples of the relationship between the time axis setting, sample rate, and record length.



**Appendix 1 Relationship between the Time Axis Setting, Sample Rate and Record Length**

Interpolation ON (Max: 1.25GS/s)  
DL9040/DL9040L/DL9140/DL9140L: Interleave mode OFF, High resolution mode ON

T/div(s/div)	2.5k	6.25k	12.5k	25k	62.5k	125k	250k	625k	1.25M	2.5M *1	6.25M *1
500ps	500GS/s	1250GS/s	2500GS/s	2500GS/s	2500GS/s	2500GS/s	2500GS/s	2500GS/s	2500GS/s	2500GS/s	2500GS/s
1ns	250GS/s	625GS/s	1250GS/s	2500GS/s	2500GS/s	2500GS/s	2500GS/s	2500GS/s	2500GS/s	2500GS/s	2500GS/s
2ns	125GS/s	312.5GS/s	625GS/s	1250GS/s	2500GS/s	2500GS/s	2500GS/s	2500GS/s	2500GS/s	2500GS/s	2500GS/s
5ns	50GS/s	125GS/s	250GS/s	500GS/s	1250GS/s	2500GS/s	2500GS/s	2500GS/s	2500GS/s	2500GS/s	2500GS/s
10ns	25GS/s	62.5GS/s	125GS/s	250GS/s	625GS/s	1250GS/s	2500GS/s	2500GS/s	2500GS/s	2500GS/s	2500GS/s
20ns	12.5GS/s	31.25GS/s	62.5GS/s	125GS/s	312.5GS/s	625GS/s	1250GS/s	2500GS/s	2500GS/s	2500GS/s	2500GS/s
50ns	5GS/s	12.5GS/s	25GS/s	50GS/s	12.5GS/s	25GS/s	50GS/s	1250GS/s	2500GS/s	2500GS/s	2500GS/s
100ns	2.5GS/s	6.25GS/s	12.5GS/s	25GS/s	6.25GS/s	12.5GS/s	25GS/s	50GS/s	1250GS/s	2500GS/s	2500GS/s
200ns	1.25GS/s	2.5GS/s	5GS/s	12.5GS/s	2.5GS/s	5GS/s	12.5GS/s	25GS/s	50GS/s	1250GS/s	2500GS/s
500ns	500MS/s	1.25GS/s	2.5GS/s	5GS/s	12.5GS/s	2.5GS/s	5GS/s	12.5GS/s	25GS/s	50GS/s	1250GS/s
1us	250MS/s	625MS/s	1.25GS/s	2.5GS/s	5GS/s	12.5GS/s	2.5GS/s	5GS/s	12.5GS/s	25GS/s	50GS/s
2us	125MS/s	312.5MS/s	625MS/s	1.25GS/s	2.5GS/s	5GS/s	12.5GS/s	2.5GS/s	5GS/s	12.5GS/s	25GS/s
5us	50MS/s	125MS/s	250MS/s	500MS/s	1.25GS/s	2.5GS/s	5GS/s	12.5GS/s	2.5GS/s	5GS/s	12.5GS/s
10us	25MS/s	62.5MS/s	125MS/s	250MS/s	625MS/s	1.25GS/s	2.5GS/s	5GS/s	12.5GS/s	2.5GS/s	5GS/s
20us	12.5MS/s	31.25MS/s	62.5MS/s	125MS/s	312.5MS/s	625MS/s	1.25GS/s	2.5GS/s	5GS/s	12.5GS/s	2.5GS/s
50us	5MS/s	12.5MS/s	25MS/s	50MS/s	12.5MS/s	25MS/s	50MS/s	125MS/s	250MS/s	500MS/s	1.25GS/s
100us	2.5MS/s	6.25MS/s	12.5MS/s	25MS/s	62.5MS/s	125MS/s	250MS/s	500MS/s	1.25GS/s	2.5GS/s	5GS/s
200us	1.25MS/s	3.125MS/s	6.25MS/s	12.5MS/s	31.25MS/s	62.5MS/s	125MS/s	250MS/s	500MS/s	1.25GS/s	2.5GS/s
500us	500KS/s	1.25MS/s	2.5MS/s	5MS/s	12.5MS/s	25MS/s	50MS/s	125MS/s	250MS/s	500MS/s	1.25GS/s
1ms	250KS/s	625KS/s	1.25MS/s	2.5MS/s	6.25MS/s	12.5MS/s	25MS/s	50MS/s	125MS/s	250MS/s	500MS/s
2ms	125KS/s	312.5KS/s	625KS/s	1.25MS/s	3.125MS/s	6.25MS/s	12.5MS/s	25MS/s	50MS/s	125MS/s	250MS/s
5ms	50KS/s	125KS/s	250KS/s	500KS/s	1.25MS/s	2.5MS/s	5MS/s	12.5MS/s	25MS/s	50MS/s	125MS/s
10ms	25KS/s	62.5KS/s	125KS/s	250KS/s	625KS/s	1.25MS/s	2.5MS/s	5MS/s	12.5MS/s	25MS/s	50MS/s
20ms	12.5KS/s	31.25KS/s	62.5KS/s	125KS/s	312.5KS/s	625KS/s	1.25MS/s	2.5MS/s	5MS/s	12.5MS/s	25MS/s
50ms	5KS/s	12.5KS/s	25KS/s	50KS/s	12.5KS/s	25KS/s	50KS/s	125KS/s	250KS/s	500KS/s	1.25MS/s
100ms	2.5KS/s	6.25KS/s	12.5KS/s	25KS/s	6.25KS/s	12.5KS/s	25KS/s	50KS/s	125KS/s	250KS/s	500KS/s
200ms	1.25KS/s	3.125KS/s	6.25KS/s	12.5KS/s	3.125KS/s	6.25KS/s	12.5KS/s	25KS/s	50KS/s	125KS/s	250KS/s
500ms	500S/s	1.25K	2.5K	5K	12.5K	25K	50K	125K	250K	500K	1.25M
1s	250S/s	625S/s	1.25K	2.5K	6.25K	12.5K	25K	50K	125K	250K	500K
2s	125S/s	312.5S/s	625S/s	1.25K	3.125K	6.25K	12.5K	25K	50K	125K	250K
5s	50S/s	125S/s	250S/s	500S/s	1.25K	2.5K	5K	12.5K	25K	50K	125K
10s	25S/s	62.5S/s	125S/s	250S/s	625S/s	1.25K	2.5K	5K	12.5K	25K	50K
20s	12.5S/s	31.25S/s	62.5S/s	125S/s	312.5S/s	625S/s	1.25K	2.5K	5K	12.5K	25K
50s	5S/s	12.5S/s	25S/s	50S/s	12.5S/s	25S/s	50S/s	125S/s	250S/s	500S/s	1.25M

Bold: Expanded interpolation or expanded repetitive sampling (variable record length)

Interpolation or repetitive sampling (when repetitive sampling mode is ON)

Interpolation

Italics: Minimum sample rate is set at 50 S/s. Record length settings are by reservation.

Envelope mode available

Roll mode available

\*1 Maximum record length in high resolution mode is 1.25 MW with the DL9040/DL9140/DL9240 and 2.5 MW with the DL9040L/DL9140L/DL9240L.

**Appendix 1 Relationship between the Time Axis Setting, Sample Rate and Record Length**

Interpolation ON (Max: 2.5GS/s)  
 a) DL9040/DL9040L/DL9140L/DL9140L: Interleave mode OFF, High resolution mode ON, High resolution mode ON, DL9040/DL9040L/DL9140L: Interleave mode ON, High resolution mode ON,  
 b) DL9040/DL9040L/DL9140L/DL9140L: Interleave mode OFF, High resolution mode OFF, High resolution mode ON  
 c) DL9240/DL9240L: Interleave mode OFF, High resolution mode ON

T/div(s/div)	2.5k	6.25k	12.5k	25k	62.5k	125k	250k	625k	1.25M	2.5M *1	6.25M *1
500ps	500GS/s	1250GS/s	2500GS/s	2500GS/s	2500GS/s	2500GS/s	2500GS/s	2500GS/s	2500GS/s	2500GS/s	2500GS/s
1ns	250GS/s	625GS/s	1250GS/s	2500GS/s	2500GS/s	2500GS/s	2500GS/s	2500GS/s	2500GS/s	2500GS/s	2500GS/s
2ns	125GS/s	312.5GS/s	625GS/s	1250GS/s	2500GS/s	2500GS/s	2500GS/s	2500GS/s	2500GS/s	2500GS/s	2500GS/s
5ns	50GS/s	125GS/s	250GS/s	500GS/s	1250GS/s	2500GS/s	2500GS/s	2500GS/s	2500GS/s	2500GS/s	2500GS/s
10ns	25GS/s	62.5GS/s	125GS/s	250GS/s	625GS/s	1250GS/s	2500GS/s	2500GS/s	2500GS/s	2500GS/s	2500GS/s
20ns	12.5GS/s	25GS/s	50GS/s	125GS/s	250GS/s	500GS/s	1250GS/s	2500GS/s	2500GS/s	2500GS/s	2500GS/s
50ns	5GS/s	12.5GS/s	25GS/s	50GS/s	125GS/s	250GS/s	500GS/s	1250GS/s	2500GS/s	2500GS/s	2500GS/s
100ns	2.5GS/s	6.25GS/s	12.5GS/s	25GS/s	50GS/s	100GS/s	250GS/s	500GS/s	1250GS/s	2500GS/s	2500GS/s
200ns	1.25GS/s	3.125GS/s	6.25GS/s	12.5GS/s	25GS/s	50GS/s	100GS/s	250GS/s	500GS/s	1250GS/s	2500GS/s
500ns	500MS/s	1250MS/s	2500MS/s	2500MS/s	2500MS/s	2500MS/s	2500MS/s	2500MS/s	2500MS/s	2500MS/s	2500MS/s
1µs	250MS/s	625MS/s	1250MS/s	2500MS/s	2500MS/s	2500MS/s	2500MS/s	2500MS/s	2500MS/s	2500MS/s	2500MS/s
2µs	125MS/s	312.5MS/s	625MS/s	1250MS/s	2500MS/s	2500MS/s	2500MS/s	2500MS/s	2500MS/s	2500MS/s	2500MS/s
5µs	50MS/s	125MS/s	250MS/s	500MS/s	1250MS/s	2500MS/s	2500MS/s	2500MS/s	2500MS/s	2500MS/s	2500MS/s
10µs	25MS/s	62.5MS/s	125MS/s	250MS/s	500MS/s	1000MS/s	2500MS/s	2500MS/s	2500MS/s	2500MS/s	2500MS/s
20µs	12.5MS/s	31.25MS/s	62.5MS/s	125MS/s	250MS/s	500MS/s	1000MS/s	2500MS/s	2500MS/s	2500MS/s	2500MS/s
50µs	5MS/s	12.5MS/s	25MS/s	50MS/s	125MS/s	250MS/s	500MS/s	1000MS/s	2500MS/s	2500MS/s	2500MS/s
100µs	2.5MS/s	6.25MS/s	12.5MS/s	25MS/s	50MS/s	100MS/s	250MS/s	500MS/s	1000MS/s	2500MS/s	2500MS/s
200µs	1.25MS/s	3.125MS/s	6.25MS/s	12.5MS/s	25MS/s	50MS/s	100MS/s	250MS/s	500MS/s	1000MS/s	2500MS/s
500µs	500K/s	1250K/s	2500K/s	2500K/s	2500K/s	2500K/s	2500K/s	2500K/s	2500K/s	2500K/s	2500K/s
1ms	250K/s	625K/s	1250K/s	2500K/s	2500K/s	2500K/s	2500K/s	2500K/s	2500K/s	2500K/s	2500K/s
2ms	125K/s	312.5K/s	625K/s	1250K/s	2500K/s	2500K/s	2500K/s	2500K/s	2500K/s	2500K/s	2500K/s
5ms	50K/s	125K/s	250K/s	500K/s	1250K/s	2500K/s	2500K/s	2500K/s	2500K/s	2500K/s	2500K/s
10ms	25K/s	62.5K/s	125K/s	250K/s	500K/s	1000K/s	2500K/s	2500K/s	2500K/s	2500K/s	2500K/s
20ms	12.5K/s	31.25K/s	62.5K/s	125K/s	250K/s	500K/s	1000K/s	2500K/s	2500K/s	2500K/s	2500K/s
50ms	5K/s	12.5K/s	25K/s	50K/s	125K/s	250K/s	500K/s	1000K/s	2500K/s	2500K/s	2500K/s
100ms	2.5K/s	6.25K/s	12.5K/s	25K/s	50K/s	100K/s	250K/s	500K/s	1000K/s	2500K/s	2500K/s
200ms	1.25K/s	3.125K/s	6.25K/s	12.5K/s	25K/s	50K/s	100K/s	250K/s	500K/s	1000K/s	2500K/s
500ms	500S/s	1250S/s	2500S/s	2500S/s	2500S/s	2500S/s	2500S/s	2500S/s	2500S/s	2500S/s	2500S/s
1s	250S/s	625S/s	1250S/s	2500S/s	2500S/s	2500S/s	2500S/s	2500S/s	2500S/s	2500S/s	2500S/s
2s	125S/s	312.5S/s	625S/s	1250S/s	2500S/s	2500S/s	2500S/s	2500S/s	2500S/s	2500S/s	2500S/s
5s	50S/s	125S/s	250S/s	500S/s	1250S/s	2500S/s	2500S/s	2500S/s	2500S/s	2500S/s	2500S/s
10s	50S/s	50S/s	50S/s	50S/s	50S/s	50S/s	50S/s	50S/s	50S/s	50S/s	50S/s
20s	50S/s	10k	50S/s	10k	50S/s	10k	50S/s	10k	50S/s	10k	50S/s
50s	50S/s	25k	50S/s	25k	125kS/s	250kS/s	500kS/s	1.25kS/s	2.5kS/s	5kS/s	12.5kS/s

**Bold:** Expanded interpolation or expanded repetitive sampling (variable record length)

**Interpolation or repetitive sampling (when repetitive sampling mode is ON)**

**Interpolation**

*Italics:* Minimum sample rate is set at 50 S/s. Record length settings are by reservation.

**Envelope mode available (c)**

**Envelope mode available (a, b)**

**Roll mode available**

\*1 Maximum record length in high resolution mode is 1.25 MW with the DL9040/DL9140/DL9240 and 2.5 MW with the DL9040L/DL9140L/DL9240L.

**Appendix 1 Relationship between the Time Axis Setting, Sample Rate and Record Length**

Interpolation ON (Max: 5GS/s)  
 a) DL9040/DL9040L/DL9040L/DL9140/DL9140L: Interleave mode ON, High resolution mode ON, High resolution mode OFF, Interleave mode OFF, b) DL9240/DL9240L: Interleave mode OFF, High resolution mode OFF, c) DL9240/DL9240L: Interleave mode ON, High resolution mode ON

T/div (div)	2.5k	6.25k	12.5k	25k	62.5k	125k	250k	625k	1.25M	2.5M *1	6.25M *1
500ps	500GS/s	1250GS/s	2500GS/s	2500GS/s	2500GS/s	2500GS/s	2500GS/s	2500GS/s	2500GS/s	2500GS/s	2500GS/s
1ns	250GS/s	625GS/s	1250GS/s	2500GS/s	2500GS/s	2500GS/s	2500GS/s	2500GS/s	2500GS/s	2500GS/s	2500GS/s
2ns	125GS/s	250GS/s	625GS/s	1250GS/s	2500GS/s	2500GS/s	2500GS/s	2500GS/s	2500GS/s	2500GS/s	2500GS/s
5ns	50GS/s	125GS/s	250GS/s	500GS/s	1250GS/s	2500GS/s	2500GS/s	2500GS/s	2500GS/s	2500GS/s	2500GS/s
10ns	25GS/s	50GS/s	125GS/s	250GS/s	625GS/s	1250GS/s	2500GS/s	2500GS/s	2500GS/s	2500GS/s	2500GS/s
20ns	10GS/s	25GS/s	50GS/s	125GS/s	250GS/s	625GS/s	1250GS/s	2500GS/s	2500GS/s	2500GS/s	2500GS/s
50ns	5GS/s	10GS/s	25GS/s	50GS/s	125GS/s	250GS/s	500GS/s	1250GS/s	2500GS/s	2500GS/s	2500GS/s
100ns	2.5GS/s	5GS/s	10GS/s	25GS/s	50GS/s	125GS/s	250GS/s	625GS/s	1250GS/s	2500GS/s	2500GS/s
200ns	1.25GS/s	2.5GS/s	5GS/s	10GS/s	25GS/s	50GS/s	125GS/s	250GS/s	625GS/s	1250GS/s	2500GS/s
500ns	500MS/s	1.25GS/s	2.5GS/s	5GS/s	10GS/s	25GS/s	50GS/s	125GS/s	250GS/s	500GS/s	1.25M
1µs	250MS/s	625MS/s	1.25GS/s	2.5GS/s	5GS/s	10GS/s	25GS/s	50GS/s	125GS/s	250GS/s	500GS/s
2µs	125MS/s	312.5MS/s	625MS/s	1.25GS/s	2.5GS/s	5GS/s	10GS/s	25GS/s	50GS/s	125GS/s	250GS/s
5µs	50MS/s	125MS/s	250MS/s	500MS/s	1.25GS/s	2.5GS/s	5GS/s	10GS/s	25GS/s	50GS/s	125GS/s
10µs	25MS/s	62.5MS/s	125MS/s	250MS/s	500MS/s	1.25GS/s	2.5GS/s	5GS/s	10GS/s	25GS/s	50GS/s
20µs	12.5MS/s	31.25MS/s	62.5MS/s	125MS/s	250MS/s	500MS/s	1.25GS/s	2.5GS/s	5GS/s	10GS/s	25GS/s
50µs	5MS/s	12.5MS/s	25MS/s	50MS/s	125MS/s	250MS/s	500MS/s	1.25GS/s	2.5GS/s	5GS/s	10GS/s
100µs	2.5MS/s	6.25MS/s	12.5MS/s	25MS/s	50MS/s	125MS/s	250MS/s	500MS/s	1.25GS/s	2.5GS/s	5GS/s
200µs	1.25MS/s	3.125MS/s	6.25MS/s	12.5MS/s	25MS/s	50MS/s	125MS/s	250MS/s	500MS/s	1.25GS/s	2.5GS/s
500µs	500KS/s	1.25MS/s	2.5MS/s	5MS/s	12.5MS/s	25MS/s	50MS/s	125MS/s	250MS/s	500MS/s	1.25MS
1ms	250KS/s	625KS/s	1.25MS/s	2.5MS/s	6.25MS/s	12.5MS/s	25MS/s	50MS/s	125MS/s	250MS/s	500MS/s
2ms	125KS/s	312.5KS/s	625KS/s	1.25MS/s	2.5MS/s	6.25MS/s	12.5MS/s	25MS/s	50MS/s	125MS/s	250MS/s
5ms	50KS/s	125KS/s	250KS/s	500KS/s	1.25MS/s	2.5MS/s	5MS/s	12.5MS/s	25MS/s	50MS/s	125MS/s
10ms	25KS/s	62.5KS/s	125KS/s	250KS/s	500KS/s	1.25MS/s	25MS/s	50MS/s	125MS/s	250MS/s	500MS/s
20ms	12.5KS/s	31.25KS/s	62.5KS/s	125KS/s	250KS/s	500KS/s	125MS/s	25MS/s	50MS/s	125MS/s	250MS/s
50ms	5KS/s	12.5KS/s	25KS/s	50KS/s	125KS/s	250KS/s	125MS/s	25MS/s	50MS/s	125MS/s	250MS/s
100ms	2.5KS/s	6.25KS/s	12.5KS/s	25KS/s	50KS/s	125KS/s	250KS/s	500KS/s	1.25MS/s	2.5MS/s	5MS/s
200ms	1.25KS/s	3.125KS/s	6.25KS/s	12.5KS/s	25KS/s	50KS/s	125KS/s	250KS/s	500KS/s	1.25MS/s	2.5MS/s
500ms	500S/s	1.25K	2.5KS/s	5KS/s	12.5KS/s	25KS/s	50KS/s	125KS/s	250KS/s	500KS/s	1.25MS/s
1s	250S/s	625S/s	1.25KS/s	2.5KS/s	6.25KS/s	12.5KS/s	25KS/s	50KS/s	125KS/s	250KS/s	500KS/s
2s	125S/s	312.5S/s	625S/s	1.25KS/s	2.5KS/s	6.25KS/s	12.5KS/s	25KS/s	50KS/s	125KS/s	250KS/s
5s	50S/s	125S/s	250S/s	500S/s	1.25KS/s	2.5KS/s	5KS/s	12.5KS/s	25KS/s	50KS/s	125KS/s
10s	50S/s	50S/s	50S/s	50S/s	50S/s	50S/s	50S/s	50S/s	50S/s	50S/s	50S/s
20s	50S/s	50S/s	50S/s	50S/s	50S/s	50S/s	50S/s	50S/s	50S/s	50S/s	50S/s
50s	50S/s	50S/s	50S/s	50S/s	50S/s	50S/s	50S/s	50S/s	50S/s	50S/s	50S/s

Bold: Expanded interpolation or expanded repetitive sampling (variable record length)

Interpolation or repetitive sampling (when repetitive sampling mode is ON)

Interpolation

Italics: Minimum sample rate is set at 50 S/s. Record length settings are by reservation

Envelope mode available (b, c)

\*1 Maximum record length in high resolution mode is 1.25 MW with the DL9040/DL9140/DL9240 and 2.5 MW with the DL9040L/DL9140L/DL9240L.

Appendix 1 Relationship between the Time Axis Setting, Sample Rate and Record Length

Interpolation ON (Max: 10GS/s)  
DL9240/DL9240L: Interleave mode ON, High resolution mode OFF

T/div(div)	2.5k	6.25k	12.5k	25k	62.5k	125k	250k	625k	1.25M	2.5M	6.25M
500ps	500GS/s	1250GS/s	2500GS/s	2500GS/s	2500GS/s	2500GS/s	2500GS/s	2500GS/s	2500GS/s	2500GS/s	2500GS/s
1ns	250GS/s	625GS/s	1250GS/s	2500GS/s	2500GS/s	2500GS/s	2500GS/s	2500GS/s	2500GS/s	2500GS/s	2500GS/s
2ns	100GS/s	250GS/s	625GS/s	1250GS/s	2500GS/s	2500GS/s	2500GS/s	2500GS/s	2500GS/s	2500GS/s	2500GS/s
5ns	50GS/s	100GS/s	250GS/s	500GS/s	1250GS/s	2500GS/s	2500GS/s	2500GS/s	2500GS/s	2500GS/s	2500GS/s
10ns	20GS/s	50GS/s	100GS/s	200GS/s	625GS/s	1250GS/s	2500GS/s	2500GS/s	2500GS/s	2500GS/s	2500GS/s
20ns	10GS/s	20GS/s	50GS/s	100GS/s	250GS/s	625GS/s	1250GS/s	2500GS/s	2500GS/s	2500GS/s	2500GS/s
50ns	5GS/s	10GS/s	20GS/s	50GS/s	100GS/s	250GS/s	500GS/s	1250GS/s	2500GS/s	2500GS/s	2500GS/s
100ns	2.5GS/s	5GS/s	10GS/s	20GS/s	50GS/s	100GS/s	250GS/s	500GS/s	1250GS/s	2500GS/s	2500GS/s
200ns	1.25GS/s	2.5GS/s	5GS/s	10GS/s	20GS/s	50GS/s	100GS/s	250GS/s	500GS/s	1250GS/s	2500GS/s
500ns	500MS/s	1.25GS/s	2.5GS/s	5GS/s	10GS/s	20GS/s	50GS/s	100GS/s	250GS/s	500GS/s	1250GS/s
1µs	250MS/s	625MS/s	1.25GS/s	2.5GS/s	5GS/s	10GS/s	20GS/s	50GS/s	100GS/s	250GS/s	500GS/s
2µs	125MS/s	312.5MS/s	625MS/s	1.25GS/s	2.5GS/s	5GS/s	10GS/s	20GS/s	50GS/s	100GS/s	250GS/s
5µs	50MS/s	125MS/s	250MS/s	500MS/s	1.25GS/s	2.5GS/s	5GS/s	10GS/s	20GS/s	50GS/s	100GS/s
10µs	25MS/s	62.5MS/s	125MS/s	250MS/s	500MS/s	1.25GS/s	2.5GS/s	5GS/s	10GS/s	20GS/s	50GS/s
20µs	12.5MS/s	31.25MS/s	62.5MS/s	125MS/s	250MS/s	500MS/s	1.25GS/s	2.5GS/s	5GS/s	10GS/s	20GS/s
50µs	5MS/s	12.5MS/s	25MS/s	50MS/s	125MS/s	250MS/s	500MS/s	1.25GS/s	2.5GS/s	5GS/s	10GS/s
100µs	2.5MS/s	6.25MS/s	12.5MS/s	25MS/s	50MS/s	125MS/s	250MS/s	500MS/s	1.25GS/s	2.5GS/s	5GS/s
200µs	1.25MS/s	3.125MS/s	6.25MS/s	12.5MS/s	25MS/s	50MS/s	125MS/s	250MS/s	500MS/s	1.25GS/s	2.5GS/s
500µs	500KS/s	1.25MS/s	2.5MS/s	5MS/s	12.5MS/s	25MS/s	50MS/s	125MS/s	250MS/s	500MS/s	1.25GS/s
1ms	250KS/s	625KS/s	1.25MS/s	2.5MS/s	6.25MS/s	12.5MS/s	25MS/s	50MS/s	125MS/s	250MS/s	500MS/s
2ms	125KS/s	312.5KS/s	625KS/s	1.25MS/s	2.5MS/s	6.25MS/s	12.5MS/s	25MS/s	50MS/s	125MS/s	250MS/s
5ms	50KS/s	125KS/s	250KS/s	500KS/s	1.25MS/s	2.5MS/s	5MS/s	12.5MS/s	25MS/s	50MS/s	125MS/s
10ms	25KS/s	62.5KS/s	125KS/s	250KS/s	500KS/s	1.25MS/s	2.5MS/s	5MS/s	12.5MS/s	25MS/s	50MS/s
20ms	12.5KS/s	31.25KS/s	62.5KS/s	125KS/s	250KS/s	500KS/s	1.25MS/s	2.5MS/s	5MS/s	12.5MS/s	25MS/s
50ms	5KS/s	12.5KS/s	25KS/s	50KS/s	125KS/s	250KS/s	500KS/s	1.25MS/s	2.5MS/s	5MS/s	12.5MS/s
100ms	2.5KS/s	6.25KS/s	12.5KS/s	25KS/s	50KS/s	125KS/s	250KS/s	500KS/s	1.25MS/s	2.5MS/s	5MS/s
200ms	1.25KS/s	3.125KS/s	6.25KS/s	12.5KS/s	25KS/s	50KS/s	125KS/s	250KS/s	500KS/s	1.25MS/s	2.5MS/s
500ms	500S/s	1.25K	2.5KS/s	5KS/s	12.5KS/s	25KS/s	50KS/s	125KS/s	250KS/s	500KS/s	1.25MS/s
1s	250S/s	625S/s	1.25KS/s	2.5KS/s	6.25KS/s	12.5KS/s	25KS/s	50KS/s	125KS/s	250KS/s	500KS/s
2s	125S/s	312.5S/s	625S/s	1.25KS/s	2.5KS/s	6.25KS/s	12.5KS/s	25KS/s	50KS/s	125KS/s	250KS/s
5s	50S/s	125S/s	250S/s	500S/s	1.25KS/s	2.5KS/s	5KS/s	12.5KS/s	25KS/s	50KS/s	125KS/s
10s	50S/s	50S/s	50S/s	50S/s	50S/s	50S/s	50S/s	50S/s	50S/s	50S/s	50S/s
20s	50S/s	10k	50S/s	125S/s	25k	62.5S/s	125S/s	25k	62.5S/s	125S/s	25k
50s	50S/s	25k	50S/s	50S/s	25k	125S/s	25k	125S/s	25k	125S/s	25k

**Bold:** Expanded interpolation or expanded repetitive sampling (variable record length)  
**Interpolation or repetitive sampling (when repetitive sampling mode is ON)**  
**Interpolation**  
*Italics:* Minimum sample rate is set at 50 S/s. Record length settings are by reservation.  
**Envelope mode available**  
**Roll mode available**

\*1 Maximum record length in high resolution mode is 1.25 MW with the DL9040/DL9140/DL9240 and 2.5 MW with the DL9040L/DL9140L/DL9240L.

**Appendix 1 Relationship between the Time Axis Setting, Sample Rate and Record Length**

Interpolation OFF. Repetitive sampling OFF (Max: 1.25GS/s)  
DL9040/DL9040L/DL9140/DL9140L: Interleave mode OFF. High resolution mode ON

T/div (s/div)	2.5k	6.25k	12.5k	25k	62.5k	125k	250k	625k	1.25M	2.5M *1	6.25M *1
50ps	500GS/s	1250GS/s	2500GS/s	2500GS/s	2500GS/s	2500GS/s	2500GS/s	2500GS/s	2500GS/s	2500GS/s	2500GS/s
1ns	250GS/s	625GS/s	1250GS/s	2500GS/s	2500GS/s	2500GS/s	2500GS/s	2500GS/s	2500GS/s	2500GS/s	2500GS/s
2ns	125GS/s	312.5GS/s	625GS/s	1250GS/s	2500GS/s	2500GS/s	2500GS/s	2500GS/s	2500GS/s	2500GS/s	2500GS/s
5ns	50GS/s	125GS/s	250GS/s	500GS/s	1250GS/s	2500GS/s	2500GS/s	2500GS/s	2500GS/s	2500GS/s	2500GS/s
10ns	1.25GS/s	250GS/s	500GS/s	1.25GS/s	250GS/s	500GS/s	1.25GS/s	250GS/s	500GS/s	1.25GS/s	250GS/s
20ns	1.25GS/s	250GS/s	1.25GS/s	1.25GS/s	1.25GS/s	1.25GS/s	1.25GS/s	1.25GS/s	1.25GS/s	1.25GS/s	1.25GS/s
50ns	1.25GS/s	625GS/s	1.25GS/s	1.25GS/s	1.25GS/s	1.25GS/s	1.25GS/s	1.25GS/s	1.25GS/s	1.25GS/s	1.25GS/s
100ns	1.25GS/s	1.25GS/s	1.25GS/s	1.25GS/s	1.25GS/s	1.25GS/s	1.25GS/s	1.25GS/s	1.25GS/s	1.25GS/s	1.25GS/s
200ns	1.25GS/s	2.5k	1.25GS/s	1.25GS/s	1.25GS/s	1.25GS/s	1.25GS/s	1.25GS/s	1.25GS/s	1.25GS/s	1.25GS/s
500ns	500MS/s	2.5k	1.25GS/s	1.25GS/s	1.25GS/s	1.25GS/s	1.25GS/s	1.25GS/s	1.25GS/s	1.25GS/s	1.25GS/s
1µs	250MS/s	2.5k	1.25GS/s	1.25GS/s	1.25GS/s	1.25GS/s	1.25GS/s	1.25GS/s	1.25GS/s	1.25GS/s	1.25GS/s
2µs	125MS/s	2.5k	1.25GS/s	1.25GS/s	1.25GS/s	1.25GS/s	1.25GS/s	1.25GS/s	1.25GS/s	1.25GS/s	1.25GS/s
5µs	50MS/s	2.5k	1.25GS/s	1.25GS/s	1.25GS/s	1.25GS/s	1.25GS/s	1.25GS/s	1.25GS/s	1.25GS/s	1.25GS/s
10µs	25MS/s	2.5k	1.25GS/s	1.25GS/s	1.25GS/s	1.25GS/s	1.25GS/s	1.25GS/s	1.25GS/s	1.25GS/s	1.25GS/s
20µs	12.5MS/s	2.5k	1.25GS/s	1.25GS/s	1.25GS/s	1.25GS/s	1.25GS/s	1.25GS/s	1.25GS/s	1.25GS/s	1.25GS/s
50µs	5MS/s	2.5k	1.25GS/s	1.25GS/s	1.25GS/s	1.25GS/s	1.25GS/s	1.25GS/s	1.25GS/s	1.25GS/s	1.25GS/s
100µs	2.5MS/s	2.5k	1.25GS/s	1.25GS/s	1.25GS/s	1.25GS/s	1.25GS/s	1.25GS/s	1.25GS/s	1.25GS/s	1.25GS/s
200µs	1.25MS/s	2.5k	1.25GS/s	1.25GS/s	1.25GS/s	1.25GS/s	1.25GS/s	1.25GS/s	1.25GS/s	1.25GS/s	1.25GS/s
500µs	500KS/s	2.5k	1.25GS/s	1.25GS/s	1.25GS/s	1.25GS/s	1.25GS/s	1.25GS/s	1.25GS/s	1.25GS/s	1.25GS/s
1ms	250KS/s	2.5k	1.25GS/s	1.25GS/s	1.25GS/s	1.25GS/s	1.25GS/s	1.25GS/s	1.25GS/s	1.25GS/s	1.25GS/s
2ms	125KS/s	2.5k	1.25GS/s	1.25GS/s	1.25GS/s	1.25GS/s	1.25GS/s	1.25GS/s	1.25GS/s	1.25GS/s	1.25GS/s
5ms	50KS/s	2.5k	1.25GS/s	1.25GS/s	1.25GS/s	1.25GS/s	1.25GS/s	1.25GS/s	1.25GS/s	1.25GS/s	1.25GS/s
10ms	25KS/s	2.5k	1.25GS/s	1.25GS/s	1.25GS/s	1.25GS/s	1.25GS/s	1.25GS/s	1.25GS/s	1.25GS/s	1.25GS/s
20ms	12.5KS/s	2.5k	1.25GS/s	1.25GS/s	1.25GS/s	1.25GS/s	1.25GS/s	1.25GS/s	1.25GS/s	1.25GS/s	1.25GS/s
50ms	5KS/s	2.5k	1.25GS/s	1.25GS/s	1.25GS/s	1.25GS/s	1.25GS/s	1.25GS/s	1.25GS/s	1.25GS/s	1.25GS/s
100ms	2.5KS/s	2.5k	1.25GS/s	1.25GS/s	1.25GS/s	1.25GS/s	1.25GS/s	1.25GS/s	1.25GS/s	1.25GS/s	1.25GS/s
200ms	1.25KS/s	2.5k	1.25GS/s	1.25GS/s	1.25GS/s	1.25GS/s	1.25GS/s	1.25GS/s	1.25GS/s	1.25GS/s	1.25GS/s
500ms	500S/s	2.5k	1.25GS/s	1.25GS/s	1.25GS/s	1.25GS/s	1.25GS/s	1.25GS/s	1.25GS/s	1.25GS/s	1.25GS/s
1s	250S/s	2.5k	1.25GS/s	1.25GS/s	1.25GS/s	1.25GS/s	1.25GS/s	1.25GS/s	1.25GS/s	1.25GS/s	1.25GS/s
2s	125S/s	2.5k	1.25GS/s	1.25GS/s	1.25GS/s	1.25GS/s	1.25GS/s	1.25GS/s	1.25GS/s	1.25GS/s	1.25GS/s
5s	50S/s	2.5k	1.25GS/s	1.25GS/s	1.25GS/s	1.25GS/s	1.25GS/s	1.25GS/s	1.25GS/s	1.25GS/s	1.25GS/s
10s	50S/s	5k	1.25GS/s	1.25GS/s	1.25GS/s	1.25GS/s	1.25GS/s	1.25GS/s	1.25GS/s	1.25GS/s	1.25GS/s
20s	50S/s	10k	1.25GS/s	1.25GS/s	1.25GS/s	1.25GS/s	1.25GS/s	1.25GS/s	1.25GS/s	1.25GS/s	1.25GS/s
50s	50S/s	25k	1.25GS/s	1.25GS/s	1.25GS/s	1.25GS/s	1.25GS/s	1.25GS/s	1.25GS/s	1.25GS/s	1.25GS/s

Repetitive sampling

Expanded normal mode (variable record length)

Bold: Expanded repetitive sampling (variable record length)

Italics: Minimum sample rate is set at 50 S/s. Record length settings are by reservation.

Envelope mode available

Roll mode available

\*1 Maximum record length in high resolution mode is 1.25 MW with the DL9040/DL9140/DL9240 and 2.5 MW with the DL9040L/DL9140L/DL9240L.

Appendix 1 Relationship between the Time Axis Setting, Sample Rate and Record Length

Interpolation OFF Repetitive sampling ON (Max: 1.25GS/s)  
DL9040/DL9040L/DL9140/DL9140L: Interleave mode OFF, High resolution mode ON

T/div(s/div)	2.5k	6.25k	12.5k	25k	62.5k	125k	250k	625k	1.25M	2.5M *1	6.25M *1
500ps	500GS/s	1250GS/s	2500GS/s	2500GS/s	2500GS/s	12.5K	2500GS/s	1.25K	2500GS/s	12.5K	2500GS/s
1ns	250GS/s	625GS/s	1250GS/s	2500GS/s	2500GS/s	25K	2500GS/s	25K	2500GS/s	25K	2500GS/s
2ns	125GS/s	312.5GS/s	625GS/s	1250GS/s	2500GS/s	50K	2500GS/s	50K	2500GS/s	50K	2500GS/s
5ns	50GS/s	125GS/s	250GS/s	500GS/s	1250GS/s	125K	2500GS/s	125K	2500GS/s	125K	2500GS/s
10ns	25GS/s	62.5GS/s	125GS/s	250GS/s	625GS/s	250K	2500GS/s	250K	2500GS/s	250K	2500GS/s
20ns	12.5GS/s	31.25GS/s	62.5GS/s	125GS/s	312.5GS/s	500K	1250GS/s	500K	2500GS/s	500K	2500GS/s
50ns	5GS/s	12.5GS/s	25GS/s	50GS/s	125GS/s	1.25M	500GS/s	250K	1250GS/s	1.25M	2500GS/s
100ns	2.5GS/s	6.25GS/s	12.5GS/s	25GS/s	62.5GS/s	2.5M	250GS/s	250K	1250GS/s	1.25M	1250GS/s
200ns	1.25GS/s	3.125GS/s	6.25GS/s	12.5GS/s	31.25GS/s	5GS/s	125GS/s	250K	625GS/s	1.25M	625GS/s
500ns	500MS/s	1.25GS/s	2.5GS/s	5GS/s	12.5GS/s	1.25GS/s	25GS/s	250K	125GS/s	1.25M	125GS/s
1us	250MS/s	625MS/s	1.25GS/s	2.5GS/s	6.25GS/s	2.5GS/s	62GS/s	250K	125GS/s	1.25M	125GS/s
5us	50MS/s	125MS/s	250MS/s	500MS/s	1.25GS/s	1.25GS/s	250MS/s	250K	125GS/s	1.25M	125GS/s
10us	25MS/s	62.5MS/s	125MS/s	250MS/s	625MS/s	250MS/s	125MS/s	250K	125GS/s	1.25M	125GS/s
20us	12.5MS/s	31.25MS/s	62.5MS/s	125MS/s	250MS/s	250MS/s	62.5MS/s	250K	125GS/s	1.25M	125GS/s
50us	5MS/s	12.5MS/s	25MS/s	50MS/s	125MS/s	250MS/s	25MS/s	250K	125GS/s	1.25M	125GS/s
100us	2.5MS/s	6.25MS/s	12.5MS/s	25MS/s	62.5MS/s	125MS/s	12.5MS/s	250K	125GS/s	1.25M	125GS/s
200us	1.25MS/s	3.125MS/s	6.25MS/s	12.5MS/s	25MS/s	62.5MS/s	6.25MS/s	250K	125GS/s	1.25M	125GS/s
500us	500KS/s	1.25MS/s	2.5MS/s	5MS/s	12.5MS/s	25MS/s	250KS/s	250K	125MS/s	1.25M	125MS/s
1ms	250KS/s	625KS/s	1.25MS/s	2.5MS/s	6.25MS/s	12.5MS/s	125KS/s	250K	62.5MS/s	1.25M	125MS/s
5ms	50KS/s	125KS/s	250KS/s	500KS/s	1.25MS/s	2.5MS/s	250KS/s	250K	12.5MS/s	1.25M	125MS/s
10ms	25KS/s	62.5KS/s	125KS/s	250KS/s	625KS/s	1.25MS/s	125KS/s	250K	6.25MS/s	1.25M	125MS/s
20ms	12.5KS/s	31.25KS/s	62.5KS/s	125KS/s	312.5KS/s	250KS/s	62.5KS/s	250K	3.125MS/s	1.25M	125MS/s
50ms	5KS/s	12.5KS/s	25KS/s	50KS/s	125KS/s	250KS/s	25KS/s	250K	1.25MS/s	1.25M	125MS/s
100ms	2.5KS/s	6.25KS/s	12.5KS/s	25KS/s	62.5KS/s	125KS/s	12.5KS/s	250K	625KS/s	1.25M	125MS/s
200ms	1.25KS/s	3.125KS/s	6.25KS/s	12.5KS/s	31.25KS/s	62.5KS/s	6.25KS/s	250K	125KS/s	1.25M	125MS/s
500ms	500S/s	1.25KS/s	2.5KS/s	5KS/s	12.5KS/s	25KS/s	500S/s	250K	125KS/s	1.25M	125MS/s
1s	250S/s	625S/s	1.25KS/s	2.5KS/s	6.25KS/s	12.5KS/s	250S/s	250K	125KS/s	1.25M	125MS/s
2s	125S/s	312.5S/s	625S/s	1.25KS/s	3.125KS/s	6.25KS/s	125S/s	250K	62.5KS/s	1.25M	125MS/s
5s	50S/s	125S/s	250S/s	500S/s	1.25KS/s	2.5KS/s	50S/s	250K	12.5KS/s	1.25M	125MS/s
10s	50S/s	5k	125S/s	250S/s	625S/s	1.25KS/s	2.5KS/s	250K	6.25KS/s	1.25M	125MS/s
20s	50S/s	10k	50S/s	10k	312.5S/s	625S/s	1.25KS/s	250K	3.125KS/s	1.25M	125MS/s
50s	50S/s	25k	50S/s	25k	125S/s	250S/s	500S/s	250K	2.5KS/s	1.25M	125MS/s

Repetitive sampling

Expanded normal mode (variable record length)

Expanded repetitive sampling (variable record length)

Italics: Minimum sample rate is set at 50 S/s. Record length settings are by reservation.

Envelope mode available

\*1 Maximum record length in high resolution mode is 1.25 MW with the DL9040/DL9140/DL9240 and 2.5 MW with the DL9040L/DL9140L/DL9240L.

Roll mode available

**Appendix 1 Relationship between the Time Axis Setting, Sample Rate and Record Length**

Interpolation OFF Repetitive sampling OFF (Max: 2.5GS/s)  
 a) DL9040/DL9040L/DL9140/DL9140L: Interleave mode OFF, High resolution mode OFF, High resolution mode ON, Interleave mode ON, High resolution mode ON,  
 b) DL9040/DL9040L/DL9140/DL9140L: Interleave mode OFF, High resolution mode OFF, High resolution mode ON, Interleave mode ON, High resolution mode ON,  
 c) DL9240/DL9240L: Interleave mode OFF, High resolution mode OFF, High resolution mode ON

T/div (s/div)	2.5k	6.25k	12.5k	25k	62.5k	125k	250k	625k	1.25M	2.5M *1	6.25M *1
500ps	500GS/s	1250GS/s	2500GS/s	2500GS/s	2500GS/s	2500GS/s	2500GS/s	2500GS/s	2500GS/s	2500GS/s	2500GS/s
1ns	250GS/s	625GS/s	1250GS/s	2500GS/s	2500GS/s	2500GS/s	2500GS/s	2500GS/s	2500GS/s	2500GS/s	2500GS/s
2ns	125GS/s	312.5GS/s	625GS/s	1250GS/s	2500GS/s	2500GS/s	2500GS/s	2500GS/s	2500GS/s	2500GS/s	2500GS/s
5ns	2.5GS/s	2.5GS/s	2.5GS/s	2.5GS/s	2.5GS/s	2.5GS/s	2.5GS/s	2.5GS/s	2.5GS/s	2.5GS/s	2.5GS/s
10ns	2.5GS/s	2.5GS/s	2.5GS/s	2.5GS/s	2.5GS/s	2.5GS/s	2.5GS/s	2.5GS/s	2.5GS/s	2.5GS/s	2.5GS/s
20ns	2.5GS/s	2.5GS/s	2.5GS/s	2.5GS/s	2.5GS/s	2.5GS/s	2.5GS/s	2.5GS/s	2.5GS/s	2.5GS/s	2.5GS/s
50ns	2.5GS/s	2.5GS/s	2.5GS/s	2.5GS/s	2.5GS/s	2.5GS/s	2.5GS/s	2.5GS/s	2.5GS/s	2.5GS/s	2.5GS/s
100ns	2.5GS/s	2.5GS/s	2.5GS/s	2.5GS/s	2.5GS/s	2.5GS/s	2.5GS/s	2.5GS/s	2.5GS/s	2.5GS/s	2.5GS/s
200ns	1.25GS/s	2.5GS/s	2.5GS/s	2.5GS/s	2.5GS/s	2.5GS/s	2.5GS/s	2.5GS/s	2.5GS/s	2.5GS/s	2.5GS/s
500ns	500MS/s	1.25GS/s	2.5GS/s	2.5GS/s	2.5GS/s	2.5GS/s	2.5GS/s	2.5GS/s	2.5GS/s	2.5GS/s	2.5GS/s
1µs	250MS/s	2.5k	625MS/s	6.25k	625MS/s	6.25k	625MS/s	6.25k	625MS/s	6.25k	625MS/s
2µs	125MS/s	2.5k	312.5MS/s	6.25k	625MS/s	6.25k	625MS/s	6.25k	625MS/s	6.25k	625MS/s
5µs	50MS/s	2.5k	125MS/s	6.25k	625MS/s	6.25k	625MS/s	6.25k	625MS/s	6.25k	625MS/s
10µs	25MS/s	2.5k	62.5MS/s	6.25k	625MS/s	6.25k	625MS/s	6.25k	625MS/s	6.25k	625MS/s
20µs	12.5MS/s	2.5k	31.25MS/s	6.25k	625MS/s	6.25k	625MS/s	6.25k	625MS/s	6.25k	625MS/s
50µs	5MS/s	2.5k	12.5MS/s	6.25k	625MS/s	6.25k	625MS/s	6.25k	625MS/s	6.25k	625MS/s
100µs	2.5MS/s	2.5k	6.25MS/s	6.25k	625MS/s	6.25k	625MS/s	6.25k	625MS/s	6.25k	625MS/s
200µs	1.25MS/s	2.5k	3.125MS/s	6.25k	625MS/s	6.25k	625MS/s	6.25k	625MS/s	6.25k	625MS/s
500µs	500K/s	2.5k	1.25MS/s	6.25k	625MS/s	6.25k	625MS/s	6.25k	625MS/s	6.25k	625MS/s
1ms	250K/s	2.5k	625K/s	6.25k	625MS/s	6.25k	625MS/s	6.25k	625MS/s	6.25k	625MS/s
2ms	125K/s	2.5k	312.5K/s	6.25k	625MS/s	6.25k	625MS/s	6.25k	625MS/s	6.25k	625MS/s
5ms	50K/s	2.5k	125K/s	6.25k	625MS/s	6.25k	625MS/s	6.25k	625MS/s	6.25k	625MS/s
10ms	25K/s	2.5k	62.5K/s	6.25k	625MS/s	6.25k	625MS/s	6.25k	625MS/s	6.25k	625MS/s
20ms	12.5K/s	2.5k	31.25K/s	6.25k	625MS/s	6.25k	625MS/s	6.25k	625MS/s	6.25k	625MS/s
50ms	5K/s	2.5k	12.5K/s	6.25k	625MS/s	6.25k	625MS/s	6.25k	625MS/s	6.25k	625MS/s
100ms	2.5K/s	2.5k	6.25K/s	6.25k	625MS/s	6.25k	625MS/s	6.25k	625MS/s	6.25k	625MS/s
200ms	1.25K/s	2.5k	3.125K/s	6.25k	625MS/s	6.25k	625MS/s	6.25k	625MS/s	6.25k	625MS/s
500ms	500S/s	2.5k	1.25K/s	6.25k	625MS/s	6.25k	625MS/s	6.25k	625MS/s	6.25k	625MS/s
1s	250S/s	2.5k	625S/s	6.25k	625MS/s	6.25k	625MS/s	6.25k	625MS/s	6.25k	625MS/s
2s	125S/s	2.5k	312.5S/s	6.25k	625MS/s	6.25k	625MS/s	6.25k	625MS/s	6.25k	625MS/s
5s	50S/s	2.5k	125S/s	6.25k	625MS/s	6.25k	625MS/s	6.25k	625MS/s	6.25k	625MS/s
10s	50S/s	5k	62.5S/s	6.25k	625MS/s	6.25k	625MS/s	6.25k	625MS/s	6.25k	625MS/s
20s	50S/s	10k	50S/s	6.25k	625MS/s	6.25k	625MS/s	6.25k	625MS/s	6.25k	625MS/s
50s	50S/s	25k	50S/s	6.25k	625MS/s	6.25k	625MS/s	6.25k	625MS/s	6.25k	625MS/s

Repetitive sampling

Expanded normal mode (variable record length)

Bold: Expanded repetitive sampling (variable record length)

Italics: Minimum sample rate is set at 50 S/s. Record length settings are by reservation.

Envelope mode available (c)

Envelope mode available (a, b)

Roll mode available

\*1 Maximum record length in high resolution mode is 1.25 MW with the DL9040/DL9140/DL9240 and 2.5 MW with the DL9040L/DL9140L/DL9240L.

Appendix 1 Relationship between the Time Axis Setting, Sample Rate and Record Length

Interpolation OFF Repetitive sampling ON (Max: 2.5GS/s)  
 a) DL9040/DL9040/DL9140/DL9140L: Interleave mode OFF, High resolution mode OFF, High resolution mode ON, Interleave mode ON, High resolution mode ON.  
 b) DL9040/DL9040/DL9140/DL9140L: Interleave mode OFF, High resolution mode OFF, High resolution mode ON, Interleave mode ON, High resolution mode ON.  
 c) DL9240/DL9240L: Interleave mode OFF, High resolution mode ON

T/div(s/div)	2.5k	6.25k	12.5k	25k	62.5k	125k	250k	625k	1.25M	2.5M *1	6.25M *1
50ps	500GSps	1250GSps	2500GSps	2500GSps	2500GSps	2500GSps	2500GSps	2500GSps	2500GSps	2500GSps	2500GSps
1ns	250GSps	625GSps	1250GSps	2500GSps	2500GSps	2500GSps	2500GSps	2500GSps	2500GSps	2500GSps	2500GSps
2ns	125GSps	312.5GSps	625GSps	1250GSps	2500GSps	2500GSps	2500GSps	2500GSps	2500GSps	2500GSps	2500GSps
5ns	50GSps	125GSps	250GSps	500GSps	1250GSps	2500GSps	2500GSps	2500GSps	2500GSps	2500GSps	2500GSps
10ns	25GSps	62.5GSps	125GSps	250GSps	625GSps	1250GSps	2500GSps	2500GSps	2500GSps	2500GSps	2500GSps
20ns	12.5GSps	31.25GSps	62.5GSps	125GSps	312.5GSps	625GSps	1250GSps	2500GSps	2500GSps	2500GSps	2500GSps
50ns	2.5GSps	6.25GSps	12.5GSps	25GSps	62.5GSps	125GSps	250GSps	500GSps	1250GSps	2500GSps	2500GSps
100ns	1.25GSps	3.125GSps	6.25GSps	12.5GSps	31.25GSps	62.5GSps	125GSps	250GSps	500GSps	1250GSps	2500GSps
200ns	625MSps	1.25GSps	2.5GSps	5GSps	12.5GSps	25GSps	50GSps	100GSps	200GSps	400GSps	800GSps
500ns	250MSps	625MSps	1.25GSps	2.5GSps	6.25GSps	12.5GSps	25GSps	50GSps	100GSps	200GSps	400GSps
1us	125MSps	312.5MSps	625MSps	1.25GSps	2.5GSps	5GSps	10GSps	20GSps	40GSps	80GSps	160GSps
2us	62.5MSps	156.25MSps	312.5MSps	625MSps	1.25GSps	2.5GSps	5GSps	10GSps	20GSps	40GSps	80GSps
5us	25MSps	62.5MSps	125MSps	250MSps	500MSps	1.25GSps	2.5GSps	5GSps	10GSps	20GSps	40GSps
10us	12.5MSps	31.25MSps	62.5MSps	125MSps	250MSps	500MSps	1.25GSps	2.5GSps	5GSps	10GSps	20GSps
20us	6.25MSps	15.625MSps	31.25MSps	62.5MSps	125MSps	250MSps	500MSps	1.25GSps	2.5GSps	5GSps	10GSps
50us	2.5MSps	6.25MSps	12.5MSps	25MSps	50MSps	100MSps	200MSps	400MSps	800MSps	1.6GSps	3.2GSps
100us	1.25MSps	3.125MSps	6.25MSps	12.5MSps	25MSps	50MSps	100MSps	200MSps	400MSps	800MSps	1.6GSps
200us	625Ksps	1.5625MSps	3.125MSps	6.25MSps	12.5MSps	25MSps	50MSps	100MSps	200MSps	400MSps	800MSps
500us	250Ksps	625Ksps	1.25MSps	2.5MSps	5MSps	10MSps	20MSps	40MSps	80MSps	160MSps	320MSps
1ms	125Ksps	312.5Ksps	625Ksps	1.25MSps	2.5MSps	5MSps	10MSps	20MSps	40MSps	80MSps	160MSps
2ms	62.5Ksps	156.25Ksps	312.5Ksps	625Ksps	1.25MSps	2.5MSps	5MSps	10MSps	20MSps	40MSps	80MSps
5ms	25Ksps	62.5Ksps	125Ksps	250Ksps	500Ksps	1.25MSps	2.5MSps	5MSps	10MSps	20MSps	40MSps
10ms	12.5Ksps	31.25Ksps	62.5Ksps	125Ksps	250Ksps	500Ksps	1.25MSps	2.5MSps	5MSps	10MSps	20MSps
20ms	6.25Ksps	15.625Ksps	31.25Ksps	62.5Ksps	125Ksps	250Ksps	500Ksps	1.25MSps	2.5MSps	5MSps	10MSps
50ms	2.5Ksps	6.25Ksps	12.5Ksps	25Ksps	50Ksps	100Ksps	200Ksps	400Ksps	800Ksps	1.6MSps	3.2MSps
100ms	1.25Ksps	3.125Ksps	6.25Ksps	12.5Ksps	25Ksps	50Ksps	100Ksps	200Ksps	400Ksps	800Ksps	1.6MSps
200ms	625Sps	1.5625Ksps	3.125Ksps	6.25Ksps	12.5Ksps	25Ksps	50Ksps	100Ksps	200Ksps	400Ksps	800Ksps
500ms	250Sps	625Sps	1.25Ksps	2.5Ksps	5Ksps	10Ksps	20Ksps	40Ksps	80Ksps	160Ksps	320Ksps
1s	125Sps	312.5Sps	625Sps	1.25Ksps	2.5Ksps	5Ksps	10Ksps	20Ksps	40Ksps	80Ksps	160Ksps
2s	62.5Sps	156.25Sps	312.5Sps	625Sps	1.25Ksps	2.5Ksps	5Ksps	10Ksps	20Ksps	40Ksps	80Ksps
5s	25Sps	62.5Sps	125Sps	250Sps	500Sps	1.25Ksps	2.5Ksps	5Ksps	10Ksps	20Ksps	40Ksps
10s	12.5Sps	31.25Sps	62.5Sps	125Sps	250Sps	500Sps	1.25Ksps	2.5Ksps	5Ksps	10Ksps	20Ksps
20s	6.25Sps	15.625Sps	31.25Sps	62.5Sps	125Sps	250Sps	500Sps	1.25Ksps	2.5Ksps	5Ksps	10Ksps
50s	2.5Sps	6.25Sps	12.5Sps	25Sps	50Sps	100Sps	200Sps	400Sps	800Sps	1.6Ksps	3.2Ksps

Repetitive sampling

Expanded normal mode (variable record length)

Bold: Expanded repetitive sampling (variable record length)

Italics: Minimum sample rate is set at 50 S/s. Record length settings are by reservation.

Envelope mode available (c)

Envelope mode available (a, b)

Roll mode available

\*1 Maximum record length in high resolution mode is 1.25 MW with the DL9040/DL9140/DL9240 and 2.5 MW with the DL9040L/DL9140L/DL9240L.



**Appendix 1 Relationship between the Time Axis Setting, Sample Rate and Record Length**

Interpolation OFF Repetitive sampling OFF (Max: 5GS/s)  
 a) DL9040/DL9040L/DL9140/DL9140L: Interleave mode ON, High resolution mode ON, High resolution mode OFF, Interleave mode OFF, High resolution mode OFF.  
 b) DL9240/DL9240L: Interleave mode ON, High resolution mode ON, High resolution mode OFF, Interleave mode OFF, High resolution mode OFF.  
 c) DL9240/DL9240L: Interleave mode ON, High resolution mode ON, High resolution mode ON, Interleave mode ON, High resolution mode ON

T/div (div)	2.5k	6.25k	12.5k	25k	62.5k	125k	250k	625k	1.25M	2.5M *1	6.25M *1
500ps	500GS/s	1250GS/s	2500GS/s	2500GS/s	2500GS/s	2500GS/s	2500GS/s	2500GS/s	2500GS/s	2500GS/s	2500GS/s
1ns	250GS/s	625GS/s	1250GS/s	2500GS/s	2500GS/s	2500GS/s	2500GS/s	2500GS/s	2500GS/s	2500GS/s	2500GS/s
2ns	5GS/s	5GS/s	5GS/s	5GS/s	5GS/s	5GS/s	5GS/s	5GS/s	5GS/s	5GS/s	5GS/s
5ns	5GS/s	5GS/s	5GS/s	5GS/s	5GS/s	5GS/s	5GS/s	5GS/s	5GS/s	5GS/s	5GS/s
10ns	5GS/s	5GS/s	5GS/s	5GS/s	5GS/s	5GS/s	5GS/s	5GS/s	5GS/s	5GS/s	5GS/s
20ns	5GS/s	5GS/s	5GS/s	5GS/s	5GS/s	5GS/s	5GS/s	5GS/s	5GS/s	5GS/s	5GS/s
50ns	5GS/s	5GS/s	5GS/s	5GS/s	5GS/s	5GS/s	5GS/s	5GS/s	5GS/s	5GS/s	5GS/s
100ns	2.5GS/s	2.5GS/s	2.5GS/s	2.5GS/s	2.5GS/s	2.5GS/s	2.5GS/s	2.5GS/s	2.5GS/s	2.5GS/s	2.5GS/s
200ns	1.25GS/s	1.25GS/s	1.25GS/s	1.25GS/s	1.25GS/s	1.25GS/s	1.25GS/s	1.25GS/s	1.25GS/s	1.25GS/s	1.25GS/s
500ns	500MS/s	1250MS/s	2500MS/s	2500MS/s	2500MS/s	2500MS/s	2500MS/s	2500MS/s	2500MS/s	2500MS/s	2500MS/s
1µs	250MS/s	625MS/s	1250MS/s	2500MS/s	2500MS/s	2500MS/s	2500MS/s	2500MS/s	2500MS/s	2500MS/s	2500MS/s
2µs	125MS/s	312.5MS/s	625MS/s	1250MS/s	1250MS/s	1250MS/s	1250MS/s	1250MS/s	1250MS/s	1250MS/s	1250MS/s
5µs	50MS/s	125MS/s	250MS/s	500MS/s	500MS/s	500MS/s	500MS/s	500MS/s	500MS/s	500MS/s	500MS/s
10µs	25MS/s	62.5MS/s	125MS/s	250MS/s	250MS/s	250MS/s	250MS/s	250MS/s	250MS/s	250MS/s	250MS/s
50µs	5MS/s	12.5MS/s	25MS/s	50MS/s	50MS/s	50MS/s	50MS/s	50MS/s	50MS/s	50MS/s	50MS/s
100µs	2.5MS/s	6.25MS/s	12.5MS/s	25MS/s	25MS/s	25MS/s	25MS/s	25MS/s	25MS/s	25MS/s	25MS/s
200µs	1.25MS/s	3.125MS/s	6.25MS/s	12.5MS/s	12.5MS/s	12.5MS/s	12.5MS/s	12.5MS/s	12.5MS/s	12.5MS/s	12.5MS/s
500µs	500K/s	1.25MS/s	2.5MS/s	5MS/s	5MS/s	5MS/s	5MS/s	5MS/s	5MS/s	5MS/s	5MS/s
1ms	250K/s	625K/s	1.25MS/s	2.5MS/s	2.5MS/s	2.5MS/s	2.5MS/s	2.5MS/s	2.5MS/s	2.5MS/s	2.5MS/s
2ms	125K/s	312.5K/s	625K/s	1.25MS/s	1.25MS/s	1.25MS/s	1.25MS/s	1.25MS/s	1.25MS/s	1.25MS/s	1.25MS/s
5ms	50K/s	125K/s	250K/s	500K/s	500K/s	500K/s	500K/s	500K/s	500K/s	500K/s	500K/s
10ms	25K/s	62.5K/s	125K/s	250K/s	250K/s	250K/s	250K/s	250K/s	250K/s	250K/s	250K/s
20ms	12.5K/s	31.25K/s	62.5K/s	125K/s	125K/s	125K/s	125K/s	125K/s	125K/s	125K/s	125K/s
50ms	5K/s	12.5K/s	25K/s	50K/s	50K/s	50K/s	50K/s	50K/s	50K/s	50K/s	50K/s
100ms	2.5K/s	6.25K/s	12.5K/s	25K/s	25K/s	25K/s	25K/s	25K/s	25K/s	25K/s	25K/s
200ms	1.25K/s	3.125K/s	6.25K/s	12.5K/s	12.5K/s	12.5K/s	12.5K/s	12.5K/s	12.5K/s	12.5K/s	12.5K/s
500ms	500S/s	1.25KS/s	2.5KS/s	5KS/s	5KS/s	5KS/s	5KS/s	5KS/s	5KS/s	5KS/s	5KS/s
1s	250S/s	625S/s	1.25KS/s	2.5KS/s	2.5KS/s	2.5KS/s	2.5KS/s	2.5KS/s	2.5KS/s	2.5KS/s	2.5KS/s
2s	125S/s	312.5S/s	625S/s	1.25KS/s	1.25KS/s	1.25KS/s	1.25KS/s	1.25KS/s	1.25KS/s	1.25KS/s	1.25KS/s
5s	50S/s	125S/s	250S/s	500S/s	500S/s	500S/s	500S/s	500S/s	500S/s	500S/s	500S/s
10s	50S/s	50S/s	50S/s	50S/s	50S/s	50S/s	50S/s	50S/s	50S/s	50S/s	50S/s
20s	50S/s	50S/s	50S/s	50S/s	50S/s	50S/s	50S/s	50S/s	50S/s	50S/s	50S/s
50s	50S/s	50S/s	50S/s	50S/s	50S/s	50S/s	50S/s	50S/s	50S/s	50S/s	50S/s

Repetitive sampling

Expanded normal mode (variable record length)

Bold: Expanded repetitive sampling (variable record length)

Italics: Minimum sample rate is set at 50 S/s. Record length settings are by reservation.

Envelope mode available (b, c)

Envelope mode available (a)

Roll mode available

\*1 Maximum record length in high resolution mode is 1.25 MW with the DL9040/DL9140/DL9240 and 2.5 MW with the DL9040L/DL9140L/DL9240L.

Appendix 1 Relationship between the Time Axis Setting, Sample Rate and Record Length

Interpolation OFF Repetitive sampling ON (Max: 5GS/s)  
 a) DL9040/DL9040L/DL9140/DL9140L: Interleave mode ON, High resolution mode ON, High resolution mode OFF, High resolution mode OFF, High resolution mode OFF.  
 b) DL9240/DL9240L: Interleave mode OFF, High resolution mode OFF, High resolution mode OFF, High resolution mode OFF, High resolution mode OFF.  
 c) DL9240/DL9240L: Interleave mode ON, High resolution mode ON

T/div(s/div)	2.5k	6.25k	12.5k	25k	62.5k	125k	250k	625k	1.25M	2.5M *1	6.25M *1
500ps	500GS/s	1250GS/s	2500GS/s	2500GS/s	2500GS/s	12.5K	2500GS/s	1.25K	2500GS/s	12.5K	2500GS/s
1ns	250GS/s	625GS/s	1250GS/s	2500GS/s	2500GS/s	25K	2500GS/s	25K	2500GS/s	25K	2500GS/s
2ns	125GS/s	312.5GS/s	625GS/s	1250GS/s	2500GS/s	50K	2500GS/s	50K	2500GS/s	50K	2500GS/s
5ns	50GS/s	125GS/s	250GS/s	500GS/s	1250GS/s	125K	2500GS/s	125K	2500GS/s	125K	2500GS/s
10ns	25GS/s	62.5GS/s	125GS/s	250GS/s	625GS/s	250K	2500GS/s	250K	2500GS/s	250K	2500GS/s
20ns	12.5GS/s	31.25GS/s	62.5GS/s	125GS/s	250GS/s	500K	2500GS/s	500K	2500GS/s	500K	2500GS/s
50ns	5GS/s	12.5GS/s	25GS/s	50GS/s	125GS/s	1.25M	2500GS/s	1.25M	2500GS/s	1.25M	2500GS/s
100ns	2.5GS/s	6.25GS/s	12.5GS/s	25GS/s	62.5GS/s	2.5M	2500GS/s	2.5M	2500GS/s	2.5M	2500GS/s
200ns	1.25GS/s	3.125GS/s	6.25GS/s	12.5GS/s	25GS/s	5K	2500GS/s	5K	2500GS/s	5K	2500GS/s
500ns	500MS/s	1250MS/s	2500MS/s	2500MS/s	12.5K	25K	2500MS/s	1.25K	2500MS/s	12.5K	2500MS/s
1us	250MS/s	625MS/s	1250MS/s	2500MS/s	25K	25K	2500MS/s	25K	2500MS/s	25K	2500MS/s
2us	125MS/s	312.5MS/s	625MS/s	1250MS/s	25K	25K	2500MS/s	25K	2500MS/s	25K	2500MS/s
5us	50MS/s	125MS/s	250MS/s	500MS/s	62.5K	125K	2500MS/s	62.5K	2500MS/s	125K	2500MS/s
10us	25MS/s	62.5MS/s	125MS/s	250MS/s	125K	250K	2500MS/s	125K	2500MS/s	250K	2500MS/s
20us	12.5MS/s	31.25MS/s	62.5MS/s	125MS/s	250K	500K	2500MS/s	250K	2500MS/s	500K	2500MS/s
50us	5MS/s	12.5MS/s	25MS/s	50MS/s	625K	1.25M	2500MS/s	625K	2500MS/s	1.25M	2500MS/s
100us	2.5MS/s	6.25MS/s	12.5MS/s	25MS/s	1.25M	2.5M	2500MS/s	1.25M	2500MS/s	2.5M	2500MS/s
200us	1.25MS/s	3.125MS/s	6.25MS/s	12.5MS/s	2.5M	5M	2500MS/s	2.5M	2500MS/s	5M	2500MS/s
500us	500KS/s	1250KS/s	2500KS/s	2500KS/s	12.5K	25K	2500KS/s	12.5K	2500KS/s	12.5K	2500KS/s
1ms	250KS/s	625KS/s	1250KS/s	2500KS/s	25K	50K	2500KS/s	25K	2500KS/s	25K	2500KS/s
2ms	125KS/s	312.5KS/s	625KS/s	1250KS/s	50K	100K	2500KS/s	50K	2500KS/s	100K	2500KS/s
5ms	50KS/s	125KS/s	250KS/s	500KS/s	125K	250K	2500KS/s	125K	2500KS/s	250K	2500KS/s
10ms	25KS/s	62.5KS/s	125KS/s	250KS/s	250K	500K	2500KS/s	250K	2500KS/s	500K	2500KS/s
20ms	12.5KS/s	31.25KS/s	62.5KS/s	125KS/s	500K	1M	2500KS/s	500K	2500KS/s	1M	2500KS/s
50ms	5KS/s	12.5KS/s	25KS/s	50KS/s	1.25M	2.5M	2500KS/s	1.25M	2500KS/s	2.5M	2500KS/s
100ms	2.5KS/s	6.25KS/s	12.5KS/s	25KS/s	2.5M	5M	2500KS/s	2.5M	2500KS/s	5M	2500KS/s
200ms	1.25KS/s	3.125KS/s	6.25KS/s	12.5KS/s	5M	10M	2500KS/s	5M	2500KS/s	10M	2500KS/s
500ms	500S/s	1250S/s	2500S/s	2500S/s	12.5K	25K	2500S/s	12.5K	2500S/s	12.5K	2500S/s
1s	250S/s	625S/s	1250S/s	2500S/s	25K	50K	2500S/s	25K	2500S/s	25K	2500S/s
2s	125S/s	312.5S/s	625S/s	1250S/s	50K	100K	2500S/s	50K	2500S/s	100K	2500S/s
5s	50S/s	125S/s	250S/s	500S/s	125K	250K	2500S/s	125K	2500S/s	250K	2500S/s
10s	25S/s	62.5S/s	125S/s	250S/s	250K	500K	2500S/s	250K	2500S/s	500K	2500S/s
20s	12.5S/s	31.25S/s	62.5S/s	125S/s	500K	1M	2500S/s	500K	2500S/s	1M	2500S/s
50s	5S/s	12.5S/s	25S/s	50S/s	1.25M	2.5M	2500S/s	1.25M	2500S/s	2.5M	2500S/s
100s	2.5S/s	6.25S/s	12.5S/s	25S/s	2.5M	5M	2500S/s	2.5M	2500S/s	5M	2500S/s

Repetitive sampling  
 Expanded normal mode (variable record length)  
 Bold: Expanded repetitive sampling (variable record length)  
 Italics: Minimum sample rate is set at 50 S/s. Record length settings are by reservation.  
 Envelope mode available (a, b)  
 Envelope mode available (c)  
 Roll mode available

\*1 Maximum record length in high resolution mode is 1.25 MW with the DL9040/DL9140/DL9240 and 2.5 MW with the DL9040L/DL9140L/DL9240L.

**Appendix 1 Relationship between the Time Axis Setting, Sample Rate and Record Length**

Interpolation OFF Repetitive sampling OFF (Max: 10GS/s)  
DL9240/DL9240L: Interleave mode ON, High resolution mode OFF

T/div (s/div)	2.5k	6.25k	12.5k	25k	62.5k	125k	250k	625k	1.25M	2.5M *1	6.25M *1
500ps	500GS/s	1250GS/s	2500GS/s	5000GS/s	12500GS/s	25000GS/s	50000GS/s	125000GS/s	250000GS/s	500000GS/s	1250000GS/s
1ns	10GS/s	10GS/s	10GS/s	10GS/s	10GS/s	10GS/s	10GS/s	10GS/s	10GS/s	10GS/s	10GS/s
2ns	10GS/s	10GS/s	10GS/s	10GS/s	10GS/s	10GS/s	10GS/s	10GS/s	10GS/s	10GS/s	10GS/s
5ns	10GS/s	10GS/s	10GS/s	10GS/s	10GS/s	10GS/s	10GS/s	10GS/s	10GS/s	10GS/s	10GS/s
10ns	10GS/s	10GS/s	10GS/s	10GS/s	10GS/s	10GS/s	10GS/s	10GS/s	10GS/s	10GS/s	10GS/s
20ns	10GS/s	10GS/s	10GS/s	10GS/s	10GS/s	10GS/s	10GS/s	10GS/s	10GS/s	10GS/s	10GS/s
50ns	5GS/s	5GS/s	5GS/s	5GS/s	5GS/s	5GS/s	5GS/s	5GS/s	5GS/s	5GS/s	5GS/s
100ns	2.5GS/s	2.5GS/s	2.5GS/s	2.5GS/s	2.5GS/s	2.5GS/s	2.5GS/s	2.5GS/s	2.5GS/s	2.5GS/s	2.5GS/s
200ns	1.25GS/s	1.25GS/s	1.25GS/s	1.25GS/s	1.25GS/s	1.25GS/s	1.25GS/s	1.25GS/s	1.25GS/s	1.25GS/s	1.25GS/s
500ns	500MS/s	1.25GS/s	2.5GS/s	5GS/s	10GS/s	20GS/s	50GS/s	100GS/s	200GS/s	500GS/s	1000GS/s
1us	250MS/s	6.25k	12.5k	25k	50k	100k	250k	500k	1000k	2500k	5000k
2us	125MS/s	6.25k	12.5k	25k	50k	100k	250k	500k	1000k	2500k	5000k
5us	50MS/s	6.25k	12.5k	25k	50k	100k	250k	500k	1000k	2500k	5000k
10us	25MS/s	6.25k	12.5k	25k	50k	100k	250k	500k	1000k	2500k	5000k
20us	12.5MS/s	6.25k	12.5k	25k	50k	100k	250k	500k	1000k	2500k	5000k
50us	5MS/s	6.25k	12.5k	25k	50k	100k	250k	500k	1000k	2500k	5000k
100us	2.5MS/s	6.25k	12.5k	25k	50k	100k	250k	500k	1000k	2500k	5000k
200us	1.25MS/s	6.25k	12.5k	25k	50k	100k	250k	500k	1000k	2500k	5000k
500us	500KS/s	6.25k	12.5k	25k	50k	100k	250k	500k	1000k	2500k	5000k
1ms	250KS/s	6.25k	12.5k	25k	50k	100k	250k	500k	1000k	2500k	5000k
2ms	125KS/s	6.25k	12.5k	25k	50k	100k	250k	500k	1000k	2500k	5000k
5ms	50KS/s	6.25k	12.5k	25k	50k	100k	250k	500k	1000k	2500k	5000k
10ms	25KS/s	6.25k	12.5k	25k	50k	100k	250k	500k	1000k	2500k	5000k
20ms	12.5KS/s	6.25k	12.5k	25k	50k	100k	250k	500k	1000k	2500k	5000k
50ms	5KS/s	6.25k	12.5k	25k	50k	100k	250k	500k	1000k	2500k	5000k
100ms	2.5KS/s	6.25k	12.5k	25k	50k	100k	250k	500k	1000k	2500k	5000k
200ms	1.25KS/s	6.25k	12.5k	25k	50k	100k	250k	500k	1000k	2500k	5000k
500ms	500S/s	6.25k	12.5k	25k	50k	100k	250k	500k	1000k	2500k	5000k
1s	250S/s	6.25k	12.5k	25k	50k	100k	250k	500k	1000k	2500k	5000k
2s	125S/s	6.25k	12.5k	25k	50k	100k	250k	500k	1000k	2500k	5000k
5s	50S/s	6.25k	12.5k	25k	50k	100k	250k	500k	1000k	2500k	5000k
10s	50S/s	6.25k	12.5k	25k	50k	100k	250k	500k	1000k	2500k	5000k
20s	50S/s	6.25k	12.5k	25k	50k	100k	250k	500k	1000k	2500k	5000k
50s	50S/s	6.25k	12.5k	25k	50k	100k	250k	500k	1000k	2500k	5000k

Repetitive sampling

Expanded normal mode (variable record length)

Bold: Expanded repetitive sampling (variable record length)

Italics: Minimum sample rate is set at 50 S/s. Record length settings are by reservation.

Envelope mode available

Roll mode available

\*1 Maximum record length in high resolution mode is 1.25 MW with the DL9040/DL9140/DL9240 and 2.5 MW with the DL9040L/DL9140L/DL9240L.

Appendix 1 Relationship between the Time Axis Setting, Sample Rate and Record Length

Interpolation OFF Repetitive sampling ON (Max: 10GS/s)  
DL9240/DL9240L: Interleave mode ON, High resolution mode OFF

T/div (s/div)	2.5k	6.25k	12.5k	25k	62.5k	125k	250k	625k	1.25M	2.5M *1	6.25M *1
50ps	500GS/s	1250GS/s	2500GS/s	2500GS/s	2500GS/s	2500GS/s	2500GS/s	2500GS/s	2500GS/s	2500GS/s	2500GS/s
1ns	250GS/s	625GS/s	1250GS/s	2500GS/s	2500GS/s	2500GS/s	2500GS/s	2500GS/s	2500GS/s	2500GS/s	2500GS/s
2ns	125GS/s	312.5GS/s	625GS/s	1250GS/s	2500GS/s	2500GS/s	2500GS/s	2500GS/s	2500GS/s	2500GS/s	2500GS/s
5ns	50GS/s	125GS/s	250GS/s	500GS/s	1250GS/s	2500GS/s	2500GS/s	2500GS/s	2500GS/s	2500GS/s	2500GS/s
10ns	25GS/s	62.5GS/s	125GS/s	250GS/s	625GS/s	1250GS/s	2500GS/s	2500GS/s	2500GS/s	2500GS/s	2500GS/s
20ns	10GS/s	31.25GS/s	62.5GS/s	125GS/s	312.5GS/s	625GS/s	1250GS/s	2500GS/s	2500GS/s	2500GS/s	2500GS/s
50ns	5GS/s	10GS/s	25GS/s	50GS/s	125GS/s	250GS/s	500GS/s	1250GS/s	2500GS/s	2500GS/s	2500GS/s
100ns	2.5GS/s	5GS/s	10GS/s	25GS/s	62.5GS/s	125GS/s	250GS/s	625GS/s	1250GS/s	2500GS/s	2500GS/s
200ns	1.25GS/s	2.5GS/s	5GS/s	10GS/s	31.25GS/s	62.5GS/s	125GS/s	312.5GS/s	625GS/s	1250GS/s	2500GS/s
500ns	500MS/s	1.25GS/s	2.5GS/s	5GS/s	10GS/s	25GS/s	50GS/s	125GS/s	250GS/s	500GS/s	1000GS/s
1us	250MS/s	625MS/s	1.25GS/s	2.5GS/s	5GS/s	10GS/s	25GS/s	50GS/s	100GS/s	250GS/s	500GS/s
2us	125MS/s	312.5MS/s	625MS/s	1.25GS/s	2.5GS/s	5GS/s	10GS/s	25GS/s	50GS/s	100GS/s	250GS/s
5us	50MS/s	125MS/s	250MS/s	500MS/s	1.25GS/s	2.5GS/s	5GS/s	10GS/s	25GS/s	50GS/s	100GS/s
10us	25MS/s	62.5MS/s	125MS/s	250MS/s	625MS/s	1.25GS/s	2.5GS/s	5GS/s	10GS/s	25GS/s	50GS/s
20us	12.5MS/s	31.25MS/s	62.5MS/s	125MS/s	312.5MS/s	625MS/s	1.25GS/s	2.5GS/s	5GS/s	10GS/s	25GS/s
50us	5MS/s	12.5MS/s	25MS/s	50MS/s	125MS/s	250MS/s	500MS/s	1.25GS/s	2.5GS/s	5GS/s	10GS/s
100us	2.5MS/s	6.25MS/s	12.5MS/s	25MS/s	62.5MS/s	125MS/s	250MS/s	500MS/s	1.25GS/s	2.5GS/s	5GS/s
200us	1.25MS/s	3.125MS/s	6.25MS/s	12.5MS/s	31.25MS/s	62.5MS/s	125MS/s	250MS/s	500MS/s	1.25GS/s	2.5GS/s
500us	500KS/s	1.25MS/s	2.5MS/s	5MS/s	12.5MS/s	25MS/s	50MS/s	100MS/s	250MS/s	500MS/s	1.25MS/s
1ms	250KS/s	625KS/s	1.25MS/s	2.5MS/s	6.25MS/s	12.5MS/s	25MS/s	50MS/s	100MS/s	250MS/s	500MS/s
2ms	125KS/s	312.5KS/s	625KS/s	1.25MS/s	3.125MS/s	6.25MS/s	12.5MS/s	25MS/s	50MS/s	100MS/s	250MS/s
5ms	50KS/s	125KS/s	250KS/s	500KS/s	1.25MS/s	2.5MS/s	5MS/s	10MS/s	25MS/s	50MS/s	100MS/s
10ms	25KS/s	62.5KS/s	125KS/s	250KS/s	625KS/s	1.25MS/s	2.5MS/s	5MS/s	10MS/s	25MS/s	50MS/s
20ms	12.5KS/s	31.25KS/s	62.5KS/s	125KS/s	312.5KS/s	625KS/s	1.25MS/s	2.5MS/s	5MS/s	10MS/s	25MS/s
50ms	5KS/s	12.5KS/s	25KS/s	50KS/s	125KS/s	250KS/s	500KS/s	1.25MS/s	2.5MS/s	5MS/s	10MS/s
100ms	2.5KS/s	6.25KS/s	12.5KS/s	25KS/s	62.5KS/s	125KS/s	250KS/s	500KS/s	1.25MS/s	2.5MS/s	5MS/s
200ms	1.25KS/s	3.125KS/s	6.25KS/s	12.5KS/s	31.25KS/s	62.5KS/s	125KS/s	250KS/s	500KS/s	1.25MS/s	2.5MS/s
500ms	500S/s	1.25KS/s	2.5KS/s	5KS/s	12.5KS/s	25KS/s	50KS/s	100KS/s	250KS/s	500KS/s	1.25MS/s
1s	250S/s	625S/s	1.25KS/s	2.5KS/s	6.25KS/s	12.5KS/s	25KS/s	50KS/s	100KS/s	250KS/s	500KS/s
2s	125S/s	312.5S/s	625S/s	1.25KS/s	3.125KS/s	6.25KS/s	12.5KS/s	25KS/s	50KS/s	100KS/s	250KS/s
5s	50S/s	125S/s	250S/s	500S/s	1.25KS/s	2.5KS/s	5KS/s	10KS/s	25KS/s	50KS/s	100KS/s
10s	50S/s	50S/s	125S/s	250S/s	625S/s	1.25KS/s	2.5KS/s	5KS/s	10KS/s	25KS/s	50KS/s
20s	50S/s	10K	50S/s	10K	312.5S/s	625S/s	1.25KS/s	2.5KS/s	5KS/s	10KS/s	25KS/s
50s	50S/s	25K	50S/s	25K	125S/s	250S/s	500S/s	1.25KS/s	2.5KS/s	5KS/s	10KS/s

Repetitive sampling

Expanded normal mode (variable record length)

Bold: Expanded repetitive sampling (variable record length)

Italic: Minimum sample rate is set at 50 S/s. Record length settings are by reservation.

Envelope mode available

Roll mode available

\*1 Maximum record length in high resolution mode is 1.25 MW with the DL9040/DL9140/DL9240 and 2.5 MW with the DL9040U/DL9140U/DL9240L.

# Appendix 2 How to Calculate the Area of a Waveform

## IntegTY

Total Area for both Positive and Negative Sides:  $S_1 + S_3 - S_2$   
 Negative Sides:  $S_1 + S_3 - S_2$

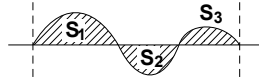

## XY display: IntegXY

### Open

(1) When Only One Y Data Corresponds to X Data

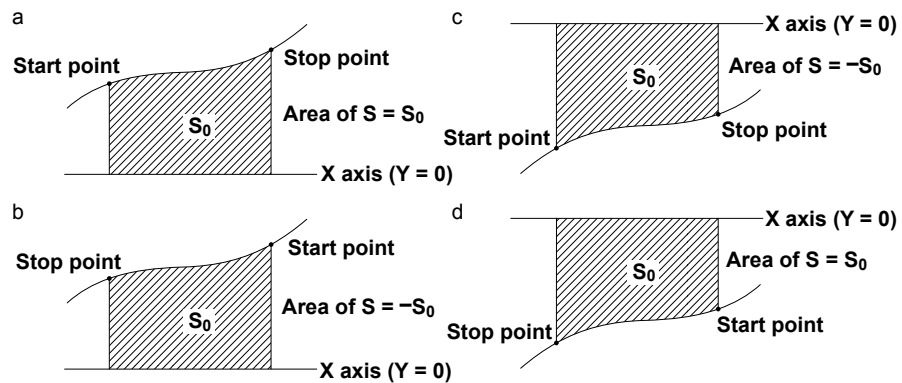

(2) When the Waveform Extends into the Negative Side

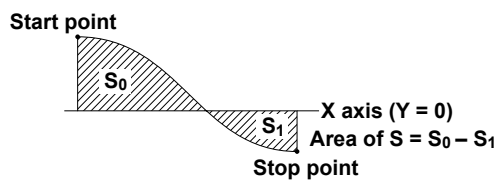

(3) When Two or more Y Data Correspond to X Data

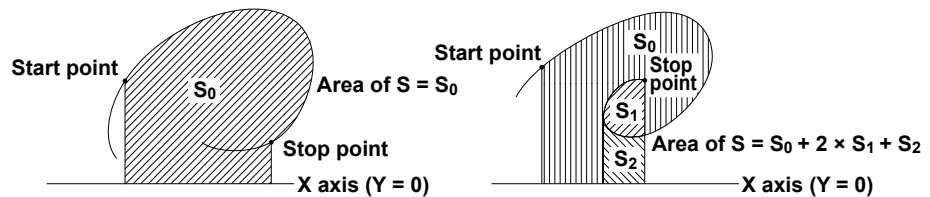

### Close

(1) Multiple Loops

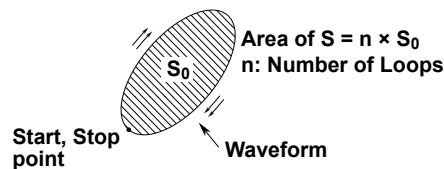

(2) Non-Closed Curve

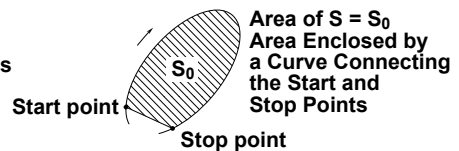

(3) Loop Tracing a Figure Eight

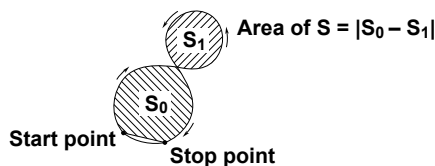

(4) Spiral Loop

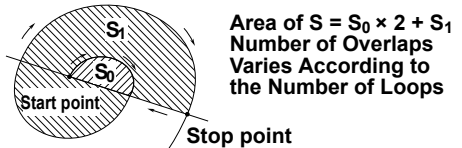

## Appendix 3 Key Assignments for the USB104 Keyboard

DL9000 Panel Key	USB Key Board
CH1	Hold down the Ctrl key and press 1
CH2	Hold down the Ctrl key and press 2
CH3	Hold down the Ctrl key and press 3
CH4	Hold down the Ctrl key and press 4
M1	Hold down the Ctrl key and press 5
M2	Hold down the Ctrl key and press 6
M3	Hold down the Ctrl key and press 7
M4	Hold down the Ctrl key and press 8
START/STOP	F12
ACQ	Hold down the Ctrl key and press a
SAMPLING/LENGTH	Hold down the Ctrl key and press g
POSITION/DELAY	Hold down the Ctrl key and press p
TRIG MODE/HOLD OFF	Hold down the Ctrl key and press t
ACQ COUNT/ACTION	Hold down the Ctrl + Shift key and press t
EDGE/STATE	Hold down the Ctrl key and press e
ENHANCED	Hold down the Ctrl key and press o
WIDTH	Hold down the Ctrl key and press w
EVENT INTERVAL	Hold down the Ctrl key and press l
SOURCE	Hold down the Ctrl key and press u
LEVEL/COUPLING	Hold down the Ctrl key and press l
CURSOR	Hold down the Ctrl key and press c
PARAM	Hold down the Ctrl key and press m
TELECOM TEST	Hold down the Ctrl + Shift key and press m
WINDOW1	Hold down the Ctrl key and press v
WINDOW2	Hold down the Ctrl key and press b
FORM	Hold down the Ctrl key and press d
ACCUM	Hold down the Ctrl key and press q
ACUUM CELAR	Hold down the Ctrl + Shift key and press q
INTENSITY $\Delta$	Hold down the Ctrl key and press Page Up
INTENSITY $\nabla$	Hold down the Ctrl key and press Page Down
ZOOM1	Hold down the Ctrl key and press z
DISP1	Hold down the Ctrl + Shift key and press z
ZOOM2	Hold down the Ctrl key and press x
DISP2	Hold down the Ctrl + Shift key and press x
SETUP	Hold down the Ctrl key and press s
HELP	Hold down the Ctrl key and press F1
HISTORY	Hold down the Ctrl key and press h
HISTORY CLEAR	Hold down the Ctrl + Shift key and press h
PRINT	PrintScreen, or hold down the Ctrl key and press PrintScreen
PRINT MENU	Hold down the Shift key and press PrintScreen, or hold down the Ctrl + Shift key and press PrintScreen
FILE	Hold down the Ctrl key and press f
SYSTEM	Hold down the Ctrl key and press /
ESC	Esc
F1	F1
F2	F2
F3	F3

**Appendix 3 Key Assignments for the USB104 Keyboard**

<b>DL9000 Panel Key</b>	<b>USB Key Board</b>
F4	F4
F5	F5
F6	F6
F7	F7
SNAP	Pause
SNAP CLEAR	Hold down the Shift key and press Pause
RESET	Hold down the Ctrl key and press r
SET	Hold down the Ctrl key and press Enter
△	↑
▽	↓
◁	←
▷	→
<b>Numeral key</b>	
1 (D)	Num'1' (Hold down the Shift key and press Num'1')
2 (E)	Num'2' (Hold down the Shift key and press Num'2')
3 (F)	Num'3' (Hold down the Shift key and press Num'3')
4 (u)	Num'4' (Hold down the Shift key and press Num'4')
5 (n)	Num'5' (Hold down the Shift key and press Num'5')
6 (p)	Num'6' (Hold down the Shift key and press Num'6')
7 (M)	Num'7' (Hold down the Shift key and press Num'7')
8 (k)	Num'8' (Hold down the Shift key and press Num'8')
9 (m)	Num'9' (Hold down the Shift key and press Num'9')
0 (A)	Num'0' (Hold down the Shift key and press Num'0')
B	Hold down the Shift key and press Num'.'
C	Hold down the Ctrl+Shift key and press Num'+', or hold down the Ctrl+Shift key and press Num'-'
±	Hold down the Ctrl key and press Num'+', or hold down the Ctrl key and press Num'-'
.	Num'.'
BS	Back Space
CLEAR	Hold down the Ctrl key and press Delete
EXP	F10
Enter	Enter
X	Hold down the Shift key and press F10
<b>Knob</b>	
<b>V POSITION</b>	
Right	Page Up
Left	Page Down
Fine/Coarse	F8
<b>V SCALE</b>	
Right	Home
Left	End
Fine/Coarse	F9
<b>T/DIV</b>	
Right	Hold down the Ctrl key and press →
Left	Hold down the Ctrl key and press ←
<b>MAG</b>	
Right	Hold down the Ctrl key and press ↑
Left	Hold down the Ctrl key and press ↓
<b>Rotary Knob</b>	
Right	Hold down the Ctrl key and press Home
Left	Hold down the Ctrl key and press End

## Appendix 4 Waveform Parameter Integrals and Derivatives

### Differentiation (DIFF)

The computation of the first order and second order differentiation uses the 5th order Lagrange interpolation formula to derive a point of data from the 5 points around the point. The data  $f_0$  to  $f_n$  and  $l_0$  to  $l_n$  corresponds to sampling time  $x_0$  to  $x_n$ .

$$\text{Point } x_k \quad f_k' = \frac{1}{12h} [fk-2 - 8fk-1 + 8fk+1 - fk+2]$$

$h = \Delta x$  is the sampling interval (sec) (example  $h = 200 \times 10^{-6}$  at 5 kHz)

### Integration (INTEG)

$$\text{Point } x_0 \quad l_0 = 0$$

$$\text{Point } x_1 \quad l_1 = \frac{1}{2}(f_0 + f_1)h$$

$$\text{Point } x_2 \quad l_2 = \frac{1}{2}(f_0 + f_1)h + \frac{1}{2}(f_1 + f_2)h = l_1 + \frac{1}{2}(f_1 + f_2)h$$

$$\text{Point } x_n \quad l_n = l_{n-1} + \frac{1}{2}(f_{n-1} + f_n)h$$



# Index

<b>A</b>	Page
AC1 MΩ	2-4
accessory	iv
accum histogram	10-85, 13-38
accumulated display	2-21
accumulation	7-8
accuracy test	18-9
ACK slot	6-97
ACQ count	7-14, 7-19
ACQ key	1-3
acquisition memory	2-1
acquisition mode	2-16, 7-1
action	7-13
action-on-trigger (GO/NO-GO)	7-16
action on trigger	2-18, 7-11
address	6-80
address type	6-80
ADR&Data trigger	6-80
all color	11-4
all condition	7-13
all half tone	11-4
all inten	11-4
allow anonymous	15-16, 15-18
arithmetic function	9-5
ASCII	13-16
attenuation constant	7-1
attenuation ratio	3-9
auto calibration	4-18
auto level mode	2-13, 6-2
automated measurement	2-27, 10-19
automated measurement (eye pattern)	10-94
auto mode	2-13, 6-2
auto name	13-9
auto scale	5-12
Auto Scale EXEC	5-11
auto scaling	2-25
auto setup	2-33, 4-11
averaging mode	2-16, 7-2
<b>B</b>	Page
backlight	8-6
bandwidth	5-7
bandwidth limit	2-5
basic waveform	7-28
beep sound (action)	7-13, 7-19
between	6-35
bit order (SPI bus)	6-108
bit pattern	6-108
bitrate	6-94
brightness	8-11
broadcast type	6-66
built-in printer	12-4
bus level	6-98
byte order	6-96
by time	6-15
<b>C</b>	Page
calibration	4-18
CAN bus trigger	2-11, 6-86, 6-101
category	7-38
CH1 to CH4 key	1-3, 5-1
chip select (SPI bus)	6-108
click sound	17-2
clock channel (state trigger)	6-29
clock signal (SPI bus)	6-108
clock source	6-72
commercial power	6-21
communication protocol	15-1
compact flash	13-1
computation channel	2-2
computed waveform	2-2
condition (SPI bus)	6-108
contents of the transmitted mail	7-15, 7-20
continuous statistic	10-32
copy	13-42
copy destination	12-4, 12-5
count condition	9-32, 9-35
count start point	9-32
CS signal	6-72
current-to-voltage conversion ratio	2-4
current probe	3-10
CURSOR key	1-4
cursor measurement	2-26, 10-1
cutoff frequency	9-24
cycle	2-12, 6-6
cycle statistical processing	10-32
<b>D</b>	Page
dark level	10-95
data bit pattern	6-95
data condition	6-80
data frame	6-95, 6-99
data position	6-108
data size	6-108, 13-16
data source	6-72
data type	13-16
date	3-16, 15-15
DC1 MΩ	2-4
DC50 Ω	2-4
decimate	13-17
default gateway	15-6
delay	2-12, 6-6
delay time (phase shift)	9-19
delay type	6-15
delet file	13-39
determination condition	7-32
determination count	7-19
determination logic	7-19
determination mode	7-37
determination time	6-36, 6-41, 6-48
determination zone	7-25, 7-28, 7-32
DHCP	15-6
dialog box	4-2
differential probe	3-10, 6-93
display format	2-21, 8-1
display history waveform (auto)	14-7
display interpolation	2-21
display ON/OFF	5-1
DNS	15-7
DNS server	15-7
domain name	15-7
dominant voltage level	6-93
dot connect	8-4

## Index

<b>E</b>		Page
edge.....	2-7	
Edge (Qualified).....	6-22, 10-40	
edge (qualified) trigger.....	2-8, 6-5	
EDGE/STATE.....	6-18	
EDGE/STATE key.....	1-3	
edge/state trigger.....	6-5	
edge count.....	2-25, 6-15, 9-30	
Edge OR.....	6-30	
edge OR trigger.....	2-9, 6-5	
edge trigger.....	2-7, 6-5, 6-18	
edge trigger (with qualification).....	6-22	
edit.....	7-28	
emission.....	19-13	
ENHANCED key.....	1-3	
enhanced trigger.....	2-11, 6-6	
enter (trigger slope).....	6-21	
entering string.....	4-4	
entering value.....	4-3	
envelope mode.....	2-16, 7-2	
erasing data.....	18-11	
error frame.....	6-100	
error message.....	18-2	
ESC key.....	1-1	
event cycle trigger.....	6-49	
event delay trigger.....	6-53	
EVENT INTERVAL key.....	1-3	
event interval trigger.....	2-12, 6-6, 6-49, 6-50, 6-51, 6-52	
event mode.....	6-52, 6-57, 6-61	
event type.....	6-50, 6-59	
event type (event delay).....	6-55	
every start trigger.....	6-80	
exit (trigger slope).....	6-21	
exponential averaging.....	2-16	
extension.....	13-9	
external dimension.....	19-15	
external signal.....	6-21	
external trigger input connector.....	16-1	
eye pattern.....	10-94	
eye pattern test.....	2-28	
<b>F</b>		Page
FET probe.....	3-10	
FFT.....	10-65	
FFT analysis.....	2-30	
FFT history search.....	11-29	
field number.....	6-66	
file attribute.....	13-39	
FILE key.....	1-5	
file server.....	15-11	
file server function.....	15-17	
filter.....	2-24, 9-20	
filter order.....	9-24	
filter type.....	9-24	
firewall.....	15-25	
first edge after delay.....	6-15	
flash ATA card.....	13-1	
flash mem.....	13-8	
float.....	13-16	
format (internal memory/built-in hard disk).....	18-12	
FORM key.....	1-4	
four-wire.....	6-108	
frame format.....	6-99	
frame skip.....	6-67	
frequency distribution.....	10-85	
front panel.....	1-1	
FTP client function.....	15-26	
functional ground terminal.....	1-1	
<b>G</b>		Page
general call trigger.....	6-82	
GMT.....	3-16	
GND.....	2-4	
GO/NO-GO decision.....	2-19	
GO/NO-GO determination condition (FFT parameter).....	7-41	
GO/NO-GO determination condition (polygon waveform).....	7-33	
GO/NO-GO determination condition (rectangular zone).....	7-29	
GO/NO-GO determination condition (telecom test).....	7-48	
GO/NO-GO determination condition (waveform parameter).....	7-37	
GO/NO-GO determination condition (waveform zone).....	7-23	
GO/NO-GO determination condition (XY waveform).....	7-45	
grade.....	7-10	
graticule.....	8-5	
Greenwich Mean Time.....	3-16	
guarantee.....	18-13	
<b>H</b>		Page
H&V cursor.....	2-26, 10-7	
handle.....	3-2	
hard disk drive.....	2-34	
HF rejection.....	2-14, 6-10	
Hi-Res Mode.....	7-3	
high-pass filter.....	2-24	
high reso.....	12-4	
high resolution mode.....	7-3	
high speed CAN.....	6-93	
histogram.....	2-31	
histogram display.....	10-74	
history memory.....	2-19, 11-5	
history search.....	2-20	
history statistics.....	10-32	
history waveform.....	2-27, 11-1	
hold-off.....	2-15	
hold off time.....	6-12	
horizontal cursor.....	2-26, 10-4, 10-16	
HS mode.....	6-84	
hysteresis.....	2-15, 6-10	
<b>I</b>		Page
I2C bus trigger.....	2-11, 6-73, 6-85	
ID bit pattern.....	6-95	
ID format.....	6-98	
IIR filter.....	9-20	
imag part.....	10-72	
immunity.....	19-14	
initialization.....	4-9	
initial point.....	9-14, 9-32	
input channel.....	2-2	
input coupling.....	2-4, 2-14, 5-6	
input waveform.....	2-2	
installation condition.....	3-3	
installation position.....	3-4	
integrating.....	9-10	
integ XY.....	10-64	
inten.....	2-21	
interleave mode.....	2-18, 7-6	
interpolation.....	2-18, 7-7	
interpolation method.....	8-3	
interval.....	6-6	
interval (mail).....	7-14, 7-20	
invert.....	5-14, 14-4	
inverted waveform display.....	2-5	
IP address.....	15-6	

<b>K</b>	Page	number of action.....	7-14
keyboard.....	2-33, 4-5	number of waveform acquisition.....	7-1
key operation.....	4-1		
key test.....	18-9		
<b>L</b>	Page	<b>O</b>	Page
label.....	14-6	offset cancel.....	5-13
latch source.....	6-72	offset voltage.....	2-5, 5-3
left-click.....	4-8	one cycle of measurement.....	2-27
less than.....	6-35	operation initial point.....	9-14
LEVEL/COUPLING key.....	1-4	operation key.....	4-1
LIN.....	2-11	ORing multiple edge trigger.....	6-30
linear interpolation.....	2-21	out of range.....	6-35
linear scaling.....	2-24, 9-1	overview.....	15-24, 18-10
line number.....	6-66	overwrite, prohibition of.....	4-15
list display.....	2-31, 10-81		
list of setup data.....	17-3	<b>P</b>	Page
lithium battery.....	3-7	P-P compress.....	13-17
loading.....	2-34	PARAM key.....	1-4
loading mask pattern.....	13-25	password.....	15-11, 15-17
loading polygon zone.....	13-25	pattern A.....	6-108
load the accumulated waveform.....	13-19	pattern format.....	6-108
load the measurement data.....	13-10	PC card.....	13-1
load the setup data.....	13-4	phase A.....	2-25, 9-35
load waveform zone.....	13-25	phase B.....	2-25
loop.....	10-64	phase compensation.....	3-13
low-pass filter.....	2-24	phase shift.....	2-24, 9-19
lower limit.....	11-23	polarity.....	10-64
low speed CAN.....	6-93	polarity (state trigger).....	6-29
		polygonal zone.....	2-20
		polygon figure.....	7-36
		POLYGON history search.....	11-24
		POSITION/DELAY key.....	1-3
		POSITION knob.....	1-3, 5-4
		power consumption.....	3-5
		power switch.....	3-6
		prescaling.....	2-24
		print.....	2-33, 12-4
		printer.....	12-1
		printer test.....	18-9
		print screen image (action).....	7-13, 7-19
		probe.....	3-9
		probe attenuation.....	2-4, 5-8
		probe attenuation ratio.....	3-9
		probe compensation signal output terminal.....	1-1
		pulse (qualified) trigger.....	2-9, 6-5, 6-38
		pulse interpolation.....	2-21
		pulse state trigger.....	2-10, 6-6, 6-43
		pulse trigger.....	2-9, 6-5, 6-35
		pulse width trigger.....	6-33
		pulse width trigger (state).....	6-43
		<b>Q</b>	Page
		qualified pulse width trigger.....	6-38
		qualify condition logic.....	6-23
		qualify condition status.....	6-23
		<b>R</b>	Page
		ranging.....	2-25, 5-11, 9-4
		rated supply voltage.....	3-5
		rated supply voltage frequency.....	3-5
		real part.....	10-72
		realtime sampling mode.....	2-17
		rear panel.....	1-2
		recessive voltage level.....	6-93
		record length.....	2-17, 7-4
		rectangular zone.....	2-20
		RECT history search.....	11-13
		reference waveform.....	2-2
<b>M</b>	Page		
M1 to M4 key.....	1-3		
MAC address.....	15-8		
MAG dial.....	1-4		
mail-mode/interval.....	7-13, 7-19		
mail transmission (action).....	7-13, 7-19		
main power switch.....	3-6		
manual scaling.....	2-25		
mapping.....	8-1		
marker cursor.....	2-26, 10-11		
mask test.....	2-28, 10-59		
mass storage.....	13-48		
MEASURE history search.....	11-18		
measurement item.....	10-25		
memory test.....	18-7		
menu language.....	17-1		
message language.....	17-1		
mode (pulse state).....	6-43		
MO disk drive.....	2-34		
more than.....	6-35		
move file.....	13-42		
moving average.....	9-25		
multiple record storing.....	13-18		
<b>N</b>	Page		
net drive.....	15-26		
net time adjust.....	15-26		
network.....	15-1		
network drive.....	2-34, 13-3		
new REF trace.....	7-28		
Nogo count.....	7-19		
Non-ACK trigger.....	6-82		
normal mode.....	2-13, 2-16, 6-2, 7-2		
notation.....	10-14		
N single mode.....	2-14, 6-2		
NTP/SNTP server.....	15-15		

## Index

reference waveform display.....	14-1
remote control client function.....	15-26
remote frame.....	6-95, 6-99
rename.....	13-45
repetitive sampling mode.....	2-18, 7-5
replacement part.....	18-13
replay.....	11-4
rescaling.....	2-24
RESET key.....	1-5
RGB video out.....	16-3
roll mode.....	2-6, 5-10
roll paper.....	12-2
rotary count.....	2-25, 9-33
rotary knob.....	1-1
rotary knob & SET.....	4-3
RTR.....	6-95
rubber feet.....	3-4

## S

	Page
safety standard.....	19-13
sample point.....	6-94
sample rate.....	2-1
SAMPLING/LENGTH key.....	1-3
sampling mode.....	2-17
save/load data on a network drive.....	15-9
save reference waveform.....	14-5
save the accumulated waveform.....	13-19
save the measurement data.....	13-10
save the setup data.....	13-4
save waveform data (action).....	7-13, 7-19
save waveform zone.....	13-25
saving.....	2-34
saving analysis result.....	13-34
saving mask pattern.....	13-25
saving polygon zone.....	13-25
saving screen image data.....	13-30
scale.....	5-9
scale conversion.....	2-25, 9-4
SCALE knob.....	1-3, 5-9
scale value.....	2-23, 5-15, 9-4, 14-6
scaling.....	9-9
scaling coefficient.....	9-4
search (edge).....	10-39
search (history waveform) .....	11-6, 11-13, 11-18, 11-24, 11-29, 11-34
search (pulse width).....	10-43
search (serial pattern).....	10-50
search (state).....	10-42
search (state condition width).....	10-47
search condition.....	11-28
search criteria.....	11-12, 11-17, 11-23, 11-33
search logic.....	11-17, 11-23, 11-33
search mode.....	11-19
search range.....	11-12, 11-33
search type.....	10-49
search zone.....	11-17
search zooming.....	10-38
select.....	11-4
self-test.....	18-7
sequence.....	2-13, 6-6
serial bus trigger.....	2-11
serial cursor.....	2-26, 10-13
serial data pattern.....	6-72
serial pattern search.....	10-50
serial pattern trigger.....	6-68
set data.....	6-95
set ID.....	6-95
SET key.....	1-5

setup dialog box.....	4-2
SETUP key.....	1-5
setup menu.....	4-1
shared folder.....	15-16
show map.....	11-4
signal input terminal.....	1-1
simple averaging.....	2-16
sine interpolation.....	2-21
single mode.....	2-14, 6-2
skip.....	10-49
smoothing.....	2-24, 9-25
snapshot.....	2-23, 8-9
soft key.....	1-1, 4-1
soft key test.....	18-9
source 1.....	2-25
source 2.....	2-25
source channel (CAN bus).....	6-98
source channel (I2C bus).....	6-84
SOURCE key.....	1-4
spare part.....	iv
SPI bus trigger.....	2-11, 6-104
splitting the screen.....	2-21
standard accessory.....	iii
start/stop.....	4-16
START/STOP key.....	1-3
start byte.....	6-83
start byte/HS mode trigger.....	6-83
starting/stopping waveform acquisition.....	4-16
state condition (state trigger).....	6-29
state trigger.....	2-8, 6-5
statistical processing.....	2-27, 10-29
storage card.....	13-8
storing recalling setting information.....	4-14
subnet mask.....	15-6
SYSTEM key.....	1-5
system overview.....	18-10

## T

	Page
T/div setting.....	5-10
TCP/IP.....	15-3
telecom test.....	2-28, 10-57
three-wire.....	6-108
time.....	3-16, 15-15
TIME/DIV knob.....	1-4
time axis scale.....	2-5
time out.....	6-35
time range.....	11-12
time stamp list.....	11-3
time window.....	2-30, 10-72
TMC.....	13-48
TMC & mass storage.....	13-48
toggle box.....	4-8
top panel.....	1-1
tracking mode.....	10-15, 10-18
trend.....	2-31
trend display.....	10-78
TRIG COMP OUT.....	16-6
trigger.....	6-58
trigger comparator signal output.....	16-6
trigger condition.....	6-68
trigger coupling.....	2-14, 6-10
trigger delay.....	2-14, 6-15, 6-17
trigger hold-off.....	2-15
trigger hysteresis.....	2-15
trigger level.....	2-7
trigger mode.....	2-13, 6-1
trigger mode (CAN bus).....	6-94
trigger mode (I2C bus).....	6-79

trigger mode (pulse width).....	6-33
trigger mode (qualified pulse width).....	6-38
trigger output .....	16-2
trigger point.....	6-17
trigger position .....	2-14, 6-17
trigger slope.....	2-7, 6-21
trigger source.....	2-7, 6-21
trigger type.....	2-7, 6-3
trigger with an external signal.....	6-21
trigger with commercial power.....	6-21
trigger with the state condition.....	6-26
TRIG MODE/HOLD OFF key .....	1-3
troubleshooting .....	18-1
TV trigger.....	2-11, 6-62

**U**

Page

upper limit.....	11-23
USB keyboard .....	2-33, 4-5
USB mouse .....	2-33
USB printer.....	12-5, 12-8, 12-9
USB storage.....	13-8
user name.....	15-11, 15-17

**V**

Page

V/div setting.....	5-9
vertical cursor .....	2-26, 10-2, 10-16
vertical position.....	2-3, 5-4
video signal output connector.....	16-3
voltage sensitivity .....	5-9
VT cursor.....	2-26, 10-10

**W**

Page

waveform assignment.....	2-21
waveform display color.....	8-11
waveform label .....	2-23, 8-8
waveform mapping .....	8-1
waveform parameter search.....	2-20
waveform zone .....	2-20
waveform zooming .....	2-22
wave history search.....	11-6
wave parameter.....	13-37
weight .....	7-1
weighted point .....	9-29
WIDTH key .....	1-3
width trigger .....	2-9, 6-5
window.....	10-72
WINDOW1.....	1-4
WINDOW2.....	1-4
window comparator .....	2-13, 6-10

**X**

Page

X-Y analysis.....	2-29
XY display.....	10-60
XY history search .....	11-34

**Z**

Page

zero light level.....	10-95
zone/parameter .....	7-13
zone search .....	2-20
zoom.....	2-22, 10-33
zoom position .....	10-37
zoom ratio.....	10-37